

First edition
2012-11-01

AMENDMENT 4
2015-09-01

**Information technology —
Telecommunications and information
exchange between systems — Local and
metropolitan area networks — Specific
requirements —**

Part 11:

**Wireless LAN medium access control
(MAC) and physical layer (PHY)
specifications**

AMENDMENT 4

*Technologies de l'information — Télécommunications et échange
d'information entre systèmes — Réseaux locaux et métropolitains —
Exigences spécifiques —*

*Partie 11: Spécifications du contrôle d'accès du milieu sans fil (MAC) et
de la couche physique (PHY)*

AMENDEMENT 4



Reference number
ISO/IEC/IEEE 8802-11:2012/Amd.4:2015(E)



© IEEE 2013

© IEEE 2013

All rights reserved. Unless otherwise specified, no part of this publication may be reproduced or utilized in any form or by any means, electronic or mechanical, including photocopying and microfilm, without permission in writing from ISO, IEC or IEEE at the respective address below.

ISO copyright office
Case postale 56
CH-1211 Geneva 20
Tel. + 41 22 749 01 11
Fax + 41 22 749 09 47
E-mail copyright@iso.org
Web www.iso.org

IEC Central Office
3, rue de Varembé
CH-1211 Geneva 20
Switzerland
E-mail inmail@iec.ch
Web www.iec.ch

Institute of Electrical and Electronics Engineers, Inc.
3 Park Avenue, New York
NY 10016-5997, USA
E-mail stds.ipr@ieee.org
Web www.ieee.org

Published in Switzerland

Foreword

ISO (the International Organization for Standardization) and IEC (the International Electrotechnical Commission) form the specialized system for worldwide standardization. National bodies that are members of ISO or IEC participate in the development of International Standards through technical committees established by the respective organization to deal with particular fields of technical activity. ISO and IEC technical committees collaborate in fields of mutual interest. Other international organizations, governmental and non-governmental, in liaison with ISO and IEC, also take part in the work. In the field of information technology, ISO and IEC have established a joint technical committee, ISO/IEC JTC 1.

IEEE Standards documents are developed within the IEEE Societies and the Standards Coordinating Committees of the IEEE Standards Association (IEEE-SA) Standards Board. The IEEE develops its standards through a consensus development process, approved by the American National Standards Institute, which brings together volunteers representing varied viewpoints and interests to achieve the final product. Volunteers are not necessarily members of the Institute and serve without compensation. While the IEEE administers the process and establishes rules to promote fairness in the consensus development process, the IEEE does not independently evaluate, test, or verify the accuracy of any of the information contained in its standards.

The main task of ISO/IEC JTC 1 is to prepare International Standards. Draft International Standards adopted by the joint technical committee are circulated to national bodies for voting. Publication as an International Standard requires approval by at least 75 % of the national bodies casting a vote.

Attention is called to the possibility that implementation of this standard may require the use of subject matter covered by patent rights. By publication of this standard, no position is taken with respect to the existence or validity of any patent rights in connection therewith. ISO/IEEE is not responsible for identifying essential patents or patent claims for which a license may be required, for conducting inquiries into the legal validity or scope of patents or patent claims or determining whether any licensing terms or conditions provided in connection with submission of a Letter of Assurance or a Patent Statement and Licensing Declaration Form, if any, or in any licensing agreements are reasonable or non-discriminatory. Users of this standard are expressly advised that determination of the validity of any patent rights, and the risk of infringement of such rights, is entirely their own responsibility. Further information may be obtained from ISO or the IEEE Standards Association.

Amendment 4 to ISO/IEC/IEEE 8802-11 was prepared by the LAN/MAN of the IEEE Computer Society (as IEEE 802.11-2013). It was adopted by Joint Technical Committee ISO/IEC JTC 1, *Information technology, Subcommittee SC 6: Telecommunications and information exchange between systems*, in parallel with its approval by the ISO/IEC national bodies, under the “fast-track procedure” defined in the Partner Standards Development Organization cooperation agreement between ISO and IEEE. IEEE is responsible for the maintenance of this document with participation and input from ISO/IEC national bodies.

(blank page)

IECNORM.COM : Click to view the full PDF of ISO/IEC/IEEE 8802-11:2012/AMD4:2015

IEEE Standard for Information technology—
Telecommunications and information exchange between systems
Local and metropolitan area networks—
Specific requirements

Part 11: Wireless LAN Medium Access Control (MAC) and Physical Layer (PHY) Specifications

Amendment 4: Enhancements for Very High Throughput for Operation in Bands below 6 GHz

IEEE Computer Society

Sponsored by the
LAN/MAN Standards Committee

IEEE
3 Park Avenue
New York, NY 10016-5997
USA

IEEE Std 802.11ac™-2013
(Amendment to
IEEE Std 802.11™-2012,
as amended by IEEE Std 802.11ae™-2012,
IEEE Std 802.11aa™-2012,
and IEEE Std 802.11ad™-2012)

IECNORM.COM : Click to view the full PDF of ISO/IEC/IEEE 8802-11:2012/AMD4:2015

IEEE Std 802.11ac™-2013

(Amendment to
IEEE Std 802.11™-2012,
as amended by IEEE Std 802.11ae™-2012,
IEEE Std 802.11aa™-2012,
and IEEE Std 802.11ad™-2012)

**IEEE Standard for Information technology—
Telecommunications and information exchange between systems
Local and metropolitan area networks—
Specific requirements**

**Part 11: Wireless LAN Medium Access Control
(MAC) and Physical Layer (PHY) Specifications**

**Amendment 4: Enhancements for Very High
Throughput for Operation in Bands below 6 GHz**

Sponsor

**LAN/MAN Standards Committee
of the
IEEE Computer Society**

Approved 11 December 2013

IEEE-SA Standards Board

IECNORM.COM : Click to view the full PDF of ISO/IEC/IEEE 8802-11:2012/Amd.4:2015

Abstract: The purpose of this amendment is to improve the IEEE 802.11™ wireless local area network (WLAN) user experience by providing significantly higher basic service set (BSS) throughput for existing WLAN application areas and to enable new market segments for operation below 6 GHz including distribution of multiple multimedia/data streams.

Keywords: 256-QAM, beamforming, IEEE 802.11ac™, multi-user MIMO, noncontiguous frequency segments, very high throughput, wider bandwidth

The Institute of Electrical and Electronics Engineers, Inc.
3 Park Avenue, New York, NY 10016-5997, USA

Copyright © 2013 by The Institute of Electrical and Electronics Engineers, Inc.
All rights reserved. Published 18 December 2013. Printed in the United States of America.

IEEE and 802 are registered trademarks in the U.S. Patent & Trademark Office, owned by The Institute of Electrical and Electronics Engineers, Incorporated.

PDF: ISBN 978-0-7381-8860-7 STD98502
Print: ISBN 978-0-7381-8861-4 STDPD98502

IEEE prohibits discrimination, harassment, and bullying.
For more information, visit <http://www.ieee.org/web/aboutus/whatis/policies/p9-26.html>.
No part of this publication may be reproduced in any form, in an electronic retrieval system or otherwise, without the prior written permission of the publisher.

Important Notices and Disclaimers Concerning IEEE Standards Documents

IEEE documents are made available for use subject to important notices and legal disclaimers. These notices and disclaimers, or a reference to this page, appear in all standards and may be found under the heading “Important Notice” or “Important Notices and Disclaimers Concerning IEEE Standards Documents.”

Notice and Disclaimer of Liability Concerning the Use of IEEE Standards Documents

IEEE Standards documents (standards, recommended practices, and guides), both full-use and trial-use, are developed within IEEE Societies and the Standards Coordinating Committees of the IEEE Standards Association (“IEEE-SA”) Standards Board. IEEE (“the Institute”) develops its standards through a consensus development process, approved by the American National Standards Institute (“ANSI”), which brings together volunteers representing varied viewpoints and interests to achieve the final product. Volunteers are not necessarily members of the Institute and participate without compensation from IEEE. While IEEE administers the process and establishes rules to promote fairness in the consensus development process, IEEE does not independently evaluate, test, or verify the accuracy of any of the information or the soundness of any judgments contained in its standards.

IEEE does not warrant or represent the accuracy or content of the material contained in its standards, and expressly disclaims all warranties (express, implied and statutory) not included in this or any other document relating to the standard, including, but not limited to, the warranties of: merchantability; fitness for a particular purpose; non-infringement; and quality, accuracy, effectiveness, currency, or completeness of material. In addition, IEEE disclaims any and all conditions relating to: results; and workmanlike effort. IEEE standards documents are supplied “AS IS” and “WITH ALL FAULTS.”

Use of an IEEE standard is wholly voluntary. The existence of an IEEE standard does not imply that there are no other ways to produce, test, measure, purchase, market, or provide other goods and services related to the scope of the IEEE standard. Furthermore, the viewpoint expressed at the time a standard is approved and issued is subject to change brought about through developments in the state of the art and comments received from users of the standard.

In publishing and making its standards available, IEEE is not suggesting or rendering professional or other services for, or on behalf of, any person or entity nor is IEEE undertaking to perform any duty owed by any other person or entity to another. Any person utilizing any IEEE Standards document, should rely upon his or her own independent judgment in the exercise of reasonable care in any given circumstances or, as appropriate, seek the advice of a competent professional in determining the appropriateness of a given IEEE standard.

IN NO EVENT SHALL IEEE BE LIABLE FOR ANY DIRECT, INDIRECT, INCIDENTAL, SPECIAL, EXEMPLARY, OR CONSEQUENTIAL DAMAGES (INCLUDING, BUT NOT LIMITED TO: PROCUREMENT OF SUBSTITUTE GOODS OR SERVICES; LOSS OF USE, DATA, OR PROFITS; OR BUSINESS INTERRUPTION) HOWEVER CAUSED AND ON ANY THEORY OF LIABILITY, WHETHER IN CONTRACT, STRICT LIABILITY, OR TORT (INCLUDING NEGLIGENCE OR OTHERWISE) ARISING IN ANY WAY OUT OF THE PUBLICATION, USE OF, OR RELIANCE UPON ANY STANDARD, EVEN IF ADVISED OF THE POSSIBILITY OF SUCH DAMAGE AND REGARDLESS OF WHETHER SUCH DAMAGE WAS FORESEEABLE.

Translations

The IEEE consensus development process involves the review of documents in English only. In the event that an IEEE standard is translated, only the English version published by IEEE should be considered the approved IEEE standard.

Official statements

A statement, written or oral, that is not processed in accordance with the IEEE-SA Standards Board Operations Manual shall not be considered or inferred to be the official position of IEEE or any of its committees and shall not be considered to be, or be relied upon as, a formal position of IEEE. At lectures, symposia, seminars, or educational courses, an individual presenting information on IEEE standards shall make it clear that his or her views should be considered the personal views of that individual rather than the formal position of IEEE.

Comments on standards

Comments for revision of IEEE Standards documents are welcome from any interested party, regardless of membership affiliation with IEEE. However, IEEE does not provide consulting information or advice pertaining to IEEE Standards documents. Suggestions for changes in documents should be in the form of a proposed change of text, together with appropriate supporting comments. Since IEEE standards represent a consensus of concerned interests, it is important that any responses to comments and questions also receive the concurrence of a balance of interests. For this reason, IEEE and the members of its societies and Standards Coordinating Committees are not able to provide an instant response to comments or questions except in those cases where the matter has previously been addressed. For the same reason, IEEE does not respond to interpretation requests. Any person who would like to participate in revisions to an IEEE standard is welcome to join the relevant IEEE working group.

Comments on standards should be submitted to the following address:

Secretary, IEEE-SA Standards Board
445 Hoes Lane
Piscataway, NJ 08854 USA

Laws and regulations

Users of IEEE Standards documents should consult all applicable laws and regulations. Compliance with the provisions of any IEEE Standards document does not imply compliance to any applicable regulatory requirements. Implementers of the standard are responsible for observing or referring to the applicable regulatory requirements. IEEE does not, by the publication of its standards, intend to urge action that is not in compliance with applicable laws, and these documents may not be construed as doing so.

Copyrights

IEEE draft and approved standards are copyrighted by IEEE under U.S. and international copyright laws. They are made available by IEEE and are adopted for a wide variety of both public and private uses. These include both use, by reference, in laws and regulations, and use in private self-regulation, standardization, and the promotion of engineering practices and methods. By making these documents available for use and adoption by public authorities and private users, IEEE does not waive any rights in copyright to the documents.

Photocopies

Subject to payment of the appropriate fee, IEEE will grant users a limited, non-exclusive license to photocopy portions of any individual standard for company or organizational internal use or individual, non-commercial use only. To arrange for payment of licensing fees, please contact Copyright Clearance Center, Customer Service, 222 Rosewood Drive, Danvers, MA 01923 USA; +1 978 750 8400. Permission to photocopy portions of any individual standard for educational classroom use can also be obtained through the Copyright Clearance Center.

Updating of IEEE Standards documents

Users of IEEE Standards documents should be aware that these documents may be superseded at any time by the issuance of new editions or may be amended from time to time through the issuance of amendments, corrigenda, or errata. An official IEEE document at any point in time consists of the current edition of the document together with any amendments, corrigenda, or errata then in effect.

Every IEEE standard is subjected to review at least every ten years. When a document is more than ten years old and has not undergone a revision process, it is reasonable to conclude that its contents, although still of some value, do not wholly reflect the present state of the art. Users are cautioned to check to determine that they have the latest edition of any IEEE standard.

In order to determine whether a given document is the current edition and whether it has been amended through the issuance of amendments, corrigenda, or errata, visit the IEEE-SA Website at <http://ieeexplore.ieee.org/xpl/standards.jsp> or contact IEEE at the address listed previously. For more information about the IEEE-SA or IEEE's standards development process, visit the IEEE-SA Website at <http://standards.ieee.org>.

Errata

Errata, if any, for all IEEE standards can be accessed on the IEEE-SA Website at the following URL: <http://standards.ieee.org/findstds/errata/index.html>. Users are encouraged to check this URL for errata periodically.

Patents

Attention is called to the possibility that implementation of this standard may require use of subject matter covered by patent rights. By publication of this standard, no position is taken by the IEEE with respect to the existence or validity of any patent rights in connection therewith. If a patent holder or patent applicant has filed a statement of assurance via an Accepted Letter of Assurance, then the statement is listed on the IEEE-SA Website at <http://standards.ieee.org/about/sasb/patcom/patents.html>. Letters of Assurance may indicate whether the Submitter is willing or unwilling to grant licenses under patent rights without compensation or under reasonable rates, with reasonable terms and conditions that are demonstrably free of any unfair discrimination to applicants desiring to obtain such licenses.

Essential Patent Claims may exist for which a Letter of Assurance has not been received. The IEEE is not responsible for identifying Essential Patent Claims for which a license may be required, for conducting inquiries into the legal validity or scope of Patents Claims, or determining whether any licensing terms or conditions provided in connection with submission of a Letter of Assurance, if any, or in any licensing agreements are reasonable or non-discriminatory. Users of this standard are expressly advised that determination of the validity of any patent rights, and the risk of infringement of such rights, is entirely their own responsibility. Further information may be obtained from the IEEE Standards Association.

Participants

At the time this standard was completed, the IEEE 802.11 Working Group had the following membership:

Bruce P. Kraemer, *Chair*
Jon W. Rosdahl and Adrian P. Stephens, *Vice-chairs*
Stephen McCann, *Secretary*

The following were officers of Task Group ac:

Osama S. Aboul-Magd, *Chair*
Joonsuk Kim and Menzo M. Wentink, *Vice-chairs*
Robert Stacey, *Technical Editor*
David Xun Yang, *Secretary*

Santosh P. Abraham	Subir Das	Yasuhiko Inoue
Roberto Aiello	Rolf J. de Vegt	Akio Iso
Carlos H. Aldana	Hossein Dehghan	Mitsuru Iwaoka
Thomas Alexander	Yohannes Demessie	ByungJang Jang Jeong
Peiman Amini	Theodorus Denteneer	Jorjeta G. Jetcheva
Sirikiat Lek Ariyavisitakul	Klaus Doppler	ZhongYi Jin
Lee R. Armstrong	Offie Drennan	Vince Jones
Yusuke Asai	Roger P. Durand	Avinash Joshi
Alex Ashley	Peter Ecclesine	Padam Kafle
Torrey Atcitty	Richard Edgar	Carl W. Kain
Kwok Shum Au	Marc Emmelmann	Naveen K. Kakani
Vijay Auluck	Leonid Epstein	Byeongwoo Kang
Stefan Aust	Vinko Erceg	Hyunduk Kang
Geert A. Awater	Ping Fang	Assaf Y. Kasher
David Bagby	Fei Qin	Shuzo Kato
Michael Bahr	Stanislav Filin	Richard H. Kennedy
Gabor Bajko	Matthew J. Fischer	John Kenney
Raja Banerjea	George Flammer	Stuart J. Kerry
Phillip Barber	Noriyasu Fukatsu	Prithpal Khakuria
John R. Barr	Patrick Fung	Thet Khine
Tuncer Baykas	Chittabrata Ghosh	Bonghoe Kim
Alan Berkema	James P. K. Gilb	Byoung-Hoon Kim
Anirudh Bhatt	Reinhard Gloger	Eun Sun Kim
Bijoy Bhukania	Daning Gong	Jinkyong Kim
Ted Booth	Michelle Gong	Suhwook Kim
Philippe Boucachard	David Goodall	Youhan Kim
Andre Bourdoux	Elad Gottlib	Youngsoo Kim
George Bumiller	Sudheer A. Grandhi	Yunjoo Kim
George Calcev	Michael Grigat	Shoichi Kitazawa
Chris Calvert	David Halasz	Tero Kivinen
Daniel Camps Mur	Mark Hamilton	Jarkko Kneckt
Laurent Cariou	Christopher J. Hansen	Gwangzeen Ko
William Carney	Hiroshi Harada	Mark M. Kobayashi
Philippe Chambelin	Dan N. Harkins	Fumihide Kojima
Kim Chang	Brian D. Hart	Tom Kolze
Clint F. Chaplin	Ahmadreza Hedayat	Timo Koskela
Bin Chen	Robert F. Heile	Thomas M. Kurihara
Minho Cheong	Guido R. Hiertz	Joseph Kwak
Inhwan Choi	Garth D. Hillman	Paul Lambert
In-Kyeong Choi	Ken Hiraga	Zhou Lan
Jee-Yon Choi	David Howard	Leonardo Lanante
Liwen Chu	Jing-Rong Hsieh	James Lansford
John Coffey	Ju-Lan Hsu	Daewon Lee
Kenneth Coop	David Hunter	Donghun Lee
Carlos Cordeiro	Sung Hyun Hwang	Jae Seung Seung Lee

Jihyun Lee	James E. Petranovich	James D. Tomcik
Yuro Lee	Albert Petrick	Ichihiko Toyoda
Zhongding Lei	John Petro	Solomon B. Trainin
Wai Kong Kong Leung	Krishna Madhavan Pillai	Ha Nguyen Tran
Honggang Li	Riku Pirhonen	Masahiro Umehira
Huan-Bang Li	Juho Pirskanen	Richard D. J. Van Nee
Lingjie Li	Vishakan Ponnampalam	Allert Van Zelst
Yunzhou Li	Ron Porat	Prabodh Varshney
Erik Lindskog	Henry S. Ptasinski	Ganesh Venkatesan
Jeremy Link	Satish Putta	Sameer Vermani
Lu Liru	Chang-Woo Chang Pyo	Dalton T. Victor
Jianhan Liu	Emily H. Qi	Gabriel Villardi
Siyang Liu	Huyu Qu	Bhupender Virk
Yong Liu	Jim E. Raab	George A. Vlastis
Peter Loc	Harish Ramamurthy	Sanjay Wadhwa
Yi Luo	Jayaram Ramasastry	Chao Chun Wang
Zhendong Luo	Ivan Reede	Haiguang Wang
Kaiying Lv	Edward Reuss	James June Wang
Bradley Lynch	Maximilian Riegel	Junyi Wang
Michael Lynch	Mark Rison	Lei Wang
Jouni K. Malinen	Dongwook Roh	Qi Wang
Hiroshi Mano	Alexander Safonov	Lisa Ward
Avi Masour	Kazuyuki Sakoda	Fujio Watanabe
Simone Merlin	Ruben Salazar Cardozo	Lei Wen
Murat Mese	Hemanth Sampath	Nicholas West
James Miller	Sigurd Schelstraete	Ian Wong
Fanny Mlinarsky	Timothy Schmidl	James Worsham
Apurva Mody	Cristina Seibert	Harry R. Worstell
Emmanuel Monnerie	Yongho Seok	Tianyu Wu
Michael Montemurro	Kunal Shah	Zhanji Wu
Rajendra T. Moorti	Huairong Shao	Akira Yamada
Hitoshi Morioka	Nir Shapira	Huanchun Ye
Andrew Myles	Steve Shearer	James Yee
Yukimasa Nagai	Stephen J. Shellhammer	Jung Yee
Hiroki Nakano	Ian Sherlock	Peter Yee
Sai Shankar Nandagopalan	Wei Shi	Su Khiong Yong
Pradeep Nemavat	Nobuhiko Shibagaki	Christopher Young
Chiu Ngo	Shusaku Shimada	Heejung Yu
Paul Nikolich	Thomas M. Siep	Artur Zaks
Knut Odman	Michael Sim	Dezhi Zhang
Hiroyo Ogawa	Dwight Smith	Hongyuan Zhang
Jong-Ee Oh	Graham Kenneth Smith	Junjian Zhang
Minseok Oh	Ill Soo Sohn	Ning Zhang
David Olson	Chunyi Song	Mu Zhao
Satoshi Oyama	Dorothy Stanley	Qiang Zhao
Santosh G. Pandey	Chin-Sean Sum	Jun Zheng
Anna Pantelidou	Bo Sun	Chunhui Zhu
Thomas Pare	Chen Sun	Lawrence Zuckerman
Jaewoo Park	Mohammad Hossein Taghavi	
Jonghyun Park	Kazuaki Takahashi	
Minyoung Park	Mineo Takai	
Seung-Hoon Park	Joseph Teo	
Sandhya Patil	Jerry Thrasher	
Eldad Perahia	Jens Tingleff	

The following members of the individual balloting committee voted on this standard. Balloters may have voted for approval, disapproval, or abstention.

Osama S. Aboul-Magd	Yasuhiko Inoue	Paul Nikolich
Tomoko Adachi	Sergiu Iordanescu	Satoshi Obara
Thomas Alexander	Akio Iso	Robert O'Hara
Nobumitsu Amachi	Atsushi Ito	Satoshi Oyama
Arthur Astrin	Mitsuru Iwaoka	Stephen Palm
Kwok Shum Au	Raj Jain	Sandhya Patil
Phillip Barber	Junghoon Jee	Eldad Perahia
Tuncer Baykas	Vincent Jones	James Petranovich
Mathild Benveniste	Bobby Jose	Brian Phelps
Nancy Bravin	Joe Natharaj Juisai	Juho Pirskanen
William Byrd	Shinkyō Kaku	Clinton Powell
George Calcev	Hyunduk Kang	Venkatesha Prasad
William Carney	Hyunjeong Kang	Michael Probasco
Juan Carreon	Piotr Karocki	Ivan Reede
Douglas Chan	Assaf Kasher	Maximilian Riegel
Xin Chang	Ruediger Kays	Robert Robinson
Hong Cheng	John Kenney	Jon W. Rosdahl
Minho Cheong	Stuart Kerry	Naotaka Sato
Paul Chiuchiolo	Yongbum Kim	Peter Saunderson
Hangyu Cho	Youhan Kim	Bartien Sayogo
Keith Chow	Gwangzeen Ko	Sigurd Schelstraete
Charles Cook	Bruce P. Kraemer	Yongho Seok
Carlos Cordeiro	Thomas Kurihara	Ian Sherlock
Neiyer Correal	Joseph Kwak	Shusaku Shimada
Alessandro De Filippo	Geoff Ladwig	Ju-Hyung Son
Michael de la Garrigue	Jeremy Landt	Myung Sun Song
Michael Denson	Nils Langhammer	Kapil Sood
Hendricus De Ruijter	James Lansford	Manikantan Srinivasan
Wael Diab	Jae Seung Lee	Robert Stacey
Patrick Diamond	Wookbong Lee	Dorothy Stanley
Roger Durand	Hyeong Ho Lee	Thomas Starai
Sourav Dutta	John Lemon	Adrian P. Stephens
Peter Ecclesine	James Lepp	Rene Struik
Richard Edgar	Joseph Levy	Walter Struppler
Marc Emmelmann	Yunbo Li	Chin-Sean Sum
David Evans	Arthur H. Light	Bo Sun
Matthew Fischer	Lu Liru	Mohammad Taghavi
George Flammer	Yi Luo	Rakesh Taori
P. Flynn	Chris Lyttle	Thomas Tetzlaff
Avraham Freedman	Elvis Maculuba	Jens Tingleff
Devon Gayle	Jouni Malinen	Keat Beng Toh
Monisha Ghosh	James Marin	Fei Tong
David Goodall	Roger Marks	Solomon Trainin
Sudheer Grandhi	Jeffery Masters	Ha Nguyen Tran
Randall Groves	W. Kyle Maus	Kazuyoshi Tsukada
Michael Gundlach	Stephen McCann	Mark-Rene Uchida
Chris Guy	Steven Methley	Richard Van Nee
Gloria Gwynne	David Mitton	Allert Van Zelst
Rainer Hach	Michael Montemurro	Dmitri Varsanofiev
David Halasz	Jose Morales	Prabodh Varshney
Hiroshi Hamano	Joseph Moran	John Vergis
Mark Hamilton	Kenichi Mori	George Vlantis
Christopher Hansen	Ronald Murias	Haiming Wang
Jerome Henry	Rick Murphy	James June Wang
Marco Hernandez	Peter Murray	Lei Wang
Dien Hoang	Andrew Myles	Xiang Wang
Werner Hoelzl	Juichi Nakada	Stephen Webb
David Howard	Michael Newman	Hung-Yu Wei
David Hunter	Charles Ngethe	Menzo M. Wentink
Noriyuki Ikeuchi	Nick S.A. Nikjoo	Tianyu Wu
		David Xun Yang

James Yee
Oren Yuen

Hongyuan Zhang
Jiayin Zhang
Daidi Zhong

Mingtuo Zhou
Chunhui Zhu

When the IEEE-SA Standards Board approved this standard on 11 December 2013, it had the following membership:

John Kulick, Chair
David J. Law, Vice Chair
Richard H. Hulett, Past Chair
Konstantinos Karachalios, Secretary

Masayuki Ariyoshi
Peter Balma
Farooq Bari
Ted Burse
Wael William Diab
Stephen Dukes
Jean-Philippe Faure
Alexander Gelman

Mark Halpin
Gary Hoffman
Paul Houzé
Jim Hughes
Michael Janezic
Joseph L. Koepfinger*
Oleg Logvinov

Ron Petersen
Gary Robinson
Jon Walter Rosdahl
Adrian Stephens
Peter Sutherland
Yafin Trivedi
Phil Winston
Yu Yuan

*Member Emeritus

Also included are the following nonvoting IEEE-SA Standards Board liaisons:

Richard DeBlasio, *DOE Representative*
Michael Janezic, *NIST Representative*

Michelle Turner
IEEE Standards Program Manager, Document Development

Kathryn Bennett
IEEE Standards Program Manager, Technical Program Development

Introduction

This introduction is not part of IEEE Std 802.11ac™-2013, IEEE Standard for Information technology—Telecommunications and information exchange between systems—Local and metropolitan area networks—Specific requirements—Part 11: Wireless LAN Medium Access Control (MAC) and Physical Layer (PHY) Specifications—Amendment 4: Enhancements for Very High Throughput for Operation in Bands below 6 GHz.

The purpose of this amendment is to improve the IEEE 802.11 wireless local area network (WLAN) user experience by providing significantly higher basic service set (BSS) throughput for existing WLAN application areas and to enable new market segments for operation below 6 GHz including distribution of multiple multimedia/data streams.

IECNORM.COM : Click to view the full PDF of ISO/IEC/IEEE 8802-11:2012/AMD4:2015

Contents

3.	Definitions, acronyms and abbreviations	2
3.1	Definitions	2
3.2	Definitions specific to IEEE 802.11	2
3.3	Abbreviations and acronyms	8
4.	General description.....	10
4.3	Components of the IEEE 802.11 architecture	10
4.3.4	Distribution system (DS) concepts	10
4.3.4.3	Robust security network association (RSNA)	10
4.3.10a	Very high throughput (VHT) STA	10
4.5	Overview of the services.....	11
4.5.4	Access control and data confidentiality services	11
4.5.4.1	General.....	11
4.5.4.7	Replay detection	11
4.5.4.9	Robust management frame protection	11
4.9	Reference model	12
4.9.1	General.....	12
5.	MAC service definition	13
5.1	Overview of MAC services	13
5.1.2	Security services	13
5.2	MAC data service specification.....	13
5.2.2	MA-UNITDATA.request	13
5.2.2.2	Semantics of the service primitive.....	13
6.	Layer management	14
6.1	Overview of management model.....	14
6.3	MLME SAP interface	14
6.3.3	Scan	14
6.3.3.3	MLME-SCAN.confirm.....	14
6.3.4	Synchronize	14
6.3.4.2	MLME-JOIN.request.....	14
6.3.7	Associate.....	15
6.3.7.2	MLME-ASSOCIATE.request	15
6.3.7.3	MLME-ASSOCIATE.confirm	16
6.3.7.4	MLME-ASSOCIATE.indication	17
6.3.7.5	MLME-ASSOCIATE.response	18
6.3.8	Reassociate	19
6.3.8.2	MLME-REASSOCIATE.request	19
6.3.8.3	MLME-REASSOCIATE.confirm	19
6.3.8.4	MLME-REASSOCIATE.indication.....	20
6.3.8.5	MLME-REASSOCIATE.response	21
6.3.11	Start.....	22
6.3.11.2	MLME-START.request.....	22
6.3.19	SetKeys.....	24
6.3.19.1	MLME-SETKEYS.request.....	24
6.5	PLME SAP interface	24
6.5.4	PLME-CHARACTERISTICS.confirm	24

6.5.4.2	Semantics of the service primitive.....	24
6.5.8	PLME-TXTIME.confirm	26
6.5.8.1	Function	26
6.5.8.2	Semantics of the service primitive.....	27
7.	PHY service specification	28
7.1	Scope.....	28
7.2	PHY functions.....	28
7.3	Detailed PHY service specifications.....	28
7.3.2	Overview of the service.....	28
7.3.4	Basic service and options	28
7.3.4.5	Vector descriptions	28
7.3.5	PHY-SAP detailed service specification	29
7.3.5.2	PHY-DATA.request	29
7.3.5.3	PHY-DATA.indication.....	29
7.3.5.6	PHY-TXSTART.confirm	29
7.3.5.11	PHY-CCA.indication.....	30
7.3.5.13	PHY-RXEND.indication	32
8.	Frame formats.....	33
8.2	MAC frame formats.....	33
8.2.3	General frame format.....	33
8.2.4	Frame fields	33
8.2.4.1	Frame Control field	33
8.2.4.2	Duration/ID field	34
8.2.4.3	Address fields	34
8.2.4.5	QoS Control field.....	34
8.2.4.6	HT Control field.....	35
8.2.4.7	Frame Body field.....	40
8.2.5	Duration/ID field (QoS STA).....	41
8.2.5.1	General.....	41
8.2.5.2	Setting for single and multiple protection under enhanced distributed channel access (EDCA).....	41
8.3	Format of individual frame types.....	42
8.3.1	Control frames	42
8.3.1.2	RTS frame format	42
8.3.1.3	CTS frame format	43
8.3.1.4	ACK frame format.....	43
8.3.1.5	PS-Poll frame format	43
8.3.1.6	CF-End frame format.....	43
8.3.1.8	BlockAckReq frame format.....	43
8.3.1.9	BlockAck frame format	44
8.3.1.20	VHT NDP Announcement frame format.....	44
8.3.1.21	Beamforming Report Poll frame format.....	45
8.3.2	Data frames.....	46
8.3.2.1	Data frame format.....	46
8.3.2.2	Aggregate MSDU (A-MSDU) format	46
8.3.3	Management frames	46
8.3.3.1	Format of management frames	46
8.3.3.2	Beacon frame format	47
8.3.3.5	Association Request frame format	48
8.3.3.6	Association Response frame format	48

8.3.3.7	Reassociation Request frame format	49
8.3.3.8	Reassociation Response frame format.....	49
8.3.3.9	Probe Request frame format	49
8.3.3.10	Probe Response frame format.....	50
8.4	Management and Extension frames body components.....	51
8.4.1	Fields that are not information elements	51
8.4.1.9	Status Code field.....	51
8.4.1.11	Action field	51
8.4.1.27	CSI Report field.....	51
8.4.1.28	Noncompressed Beamforming Report field	51
8.4.1.29	Compressed Beamforming Report field	52
8.4.1.32	Rate Identification field	52
8.4.1.47	VHT MIMO Control field	53
8.4.1.48	VHT Compressed Beamforming Report field.....	55
8.4.1.49	MU Exclusive Beamforming Report field.....	64
8.4.1.50	Operating Mode field.....	68
8.4.1.51	Membership Status Array field.....	69
8.4.1.52	User Position Array field	70
8.4.2	Information elements	71
8.4.2.1	General.....	71
8.4.2.3	Supported Rates element	71
8.4.2.10	Country element	71
8.4.2.17	Power Capability element.....	74
8.4.2.22	Secondary Channel Offset element.....	75
8.4.2.23	Measurement Request element	75
8.4.2.24	Measurement Report element	79
8.4.2.27	RSNE	82
8.4.2.29	Extended Capabilities element	84
8.4.2.31	EDCA Parameter Set element	85
8.4.2.38	AP Channel Report element	85
8.4.2.39	Neighbor Report element.....	86
8.4.2.40	RCPI element.....	87
8.4.2.48	Multiple BSSID element	87
8.4.2.56	Supported Operating Classes element	87
8.4.2.57	Management MIC element	88
8.4.2.58	HT Capabilities element	89
8.4.2.59	HT Operation element	91
8.4.2.69	Event Request element	91
8.4.2.70	Event Report element	91
8.4.2.71	Diagnostic Request element	92
8.4.2.73	Location Parameters element.....	92
8.4.2.88	Channel Usage element	93
8.4.2.160	VHT Capabilities element	93
8.4.2.161	VHT Operation element	98
8.4.2.162	Extended BSS Load element	99
8.4.2.163	Wide Bandwidth Channel Switch element	100
8.4.2.164	VHT Transmit Power Envelope element.....	101
8.4.2.165	Channel Switch Wrapper element	102
8.4.2.166	AID element	103
8.4.2.167	Quiet Channel element	104
8.4.2.168	Operating Mode Notification element.....	104
8.5	Action frame format details	105
8.5.2	Spectrum management Action frames.....	105
8.5.2.6	Channel Switch Announcement frame format	105

8.5.4	DLS Action frame details	106
8.5.4.2	DLS Request frame format	106
8.5.4.3	DLS Response frame format	106
8.5.8	Public Action details.....	106
8.5.8.3	Measurement Pilot frame format	106
8.5.8.7	Extended Channel Switch Announcement frame format	107
8.5.8.16	TDLS Discovery Response frame format	107
8.5.13	TDLS Action frame details.....	108
8.5.13.2	TDLS Setup Request Action field format	108
8.5.13.3	TDLS Setup Response Action field format.....	108
8.5.13.4	TDLS Setup Confirm Action field format.....	109
8.5.13.7	TDLS Channel Switch Request Action field format	109
8.5.14	WNM Action fields	110
8.5.14.24	Channel Usage Response frame format.....	110
8.5.16	Self-protected Action frame details.....	110
8.5.16.2	Mesh Peering Open frame format	110
8.5.16.3	Mesh Peering Confirm frame format.....	111
8.5.23	VHT Action frame details	111
8.5.23.1	VHT Action field.....	111
8.5.23.2	VHT Compressed Beamforming frame format	112
8.5.23.3	Group ID Management frame format.....	112
8.5.23.4	Operating Mode Notification frame format.....	113
8.6	Aggregate MPDU (A-MPDU).....	113
8.6.1	A-MPDU format.....	113
8.6.3	A-MPDU contents	116
9.	MAC sublayer functional description.....	118
9.2	MAC architecture	118
9.2.1	General.....	118
9.2.4	Hybrid coordination function (HCF).....	118
9.2.4.1	General.....	118
9.2.4.2	HCF contention-based channel access (EDCA).....	119
9.2.7	Fragmentation/defragmentation overview.....	119
9.3	DCF.....	120
9.3.1	General.....	120
9.3.2	Procedures common to both DCF and EDCAF.....	120
9.3.2.3	IFS	120
9.3.2.5a	VHT RTS procedure.....	121
9.3.2.6	CTS and DMG CTS procedure	121
9.3.2.7	Dual CTS protection.....	122
9.3.2.9a	MU acknowledgment procedure	122
9.3.4	DCF access procedure	124
9.3.4.4	Recovery procedures and retransmit limits	124
9.3.7	DCF timing relations	124
9.5	Fragmentation	124
9.7	Multirate support.....	125
9.7.1	Overview	125
9.7.4	Basic Rate Set and Basic MCS Set for mesh STA.....	125
9.7.5	Rate selection for data and management frames	125
9.7.5.3	Rate selection for other group addressed data and management frames ...	125
9.7.5.5a	Rate selection for data frames sent within an FMS stream	125
9.7.5.6	Rate selection for other <u>individually addressed</u> data and management frames	126

9.7.6	Rate selection for control frames.....	127
9.7.6.1	General rules for rate selection for control frames.....	127
9.7.6.2	Rate selection for control frames that initiate a TXOP.....	128
9.7.6.4	Rate selection for control frames that are not control response frames.....	128
9.7.6.5	Rate selection for control response frames.....	129
9.7.6.6	Channel Width selection for control frames.....	132
9.7.8	Modulation classes.....	134
9.7.9	Non-HT basic rate calculation.....	135
9.7.10	Channel Width in non-HT and non-HT duplicate PPDUs.....	135
9.7.11	Rate selection constraints for VHT STAs.....	136
9.7.11.1	Rx Supported VHT-MCS and NSS Set.....	136
9.7.11.2	Tx Supported VHT-MCS and NSS Set.....	136
9.7.11.3	Additional rate selection constraints for VHT PPDUs.....	137
9.9	HT Control field operation.....	138
9.11	A-MSDU operation.....	138
9.12	A-MPDU operation.....	139
9.12.2	A-MPDU length limit rules.....	139
9.12.3	Minimum MPDU Start Spacing field.....	140
9.12.4	A-MPDU aggregation of group addressed data frames.....	140
9.12.5	Transport of A-MPDU by the PHY data service.....	141
9.12.6	A-MPDU padding for VHT PPDU.....	141
9.12.7	Setting the EOF field of the MPDU delimiter.....	142
9.12.8	Transport of VHT single MPDUs.....	143
9.15	STBC operation.....	143
9.16	Short GI operation.....	143
9.17a	Group ID and partial AID in VHT PPDUs.....	145
9.18	Operation across regulatory domains.....	146
9.18.5	Operation with operating classes and the VHT Transmit Power Envelope element.....	146
9.19	HCF.....	147
9.19.2	HCF contention-based channel access (EDCA).....	147
9.19.2.2	EDCA TXOPs.....	147
9.19.2.3	Obtaining an EDCA TXOP.....	148
9.19.2.3a	Sharing an EDCA TXOP.....	149
9.19.2.4	Multiple frame transmission in an EDCA TXOP.....	149
9.19.2.5	EDCA backoff procedure.....	151
9.19.2.6	Retransmit procedures.....	153
9.19.2.7	Truncation of a TXOP.....	154
9.19.2.8	EDCA channel access in a VHT BSS.....	154
9.19.3	HCCA.....	155
9.19.3.2	HCCA procedure.....	155
9.19.3.5	HCCA transfer rules.....	155
9.21	Block Acknowledgment (Block Ack).....	156
9.21.10	GCR Block Ack.....	156
9.21.10.3	GCR Block Ack BlockAckReq and BlockAck frame exchanges.....	156
9.23	Protection mechanisms.....	156
9.23.5	L-SIG TXOP protection.....	156
9.23.5.3	L-SIG TXOP protection rules at the TXOP responder.....	156
9.23.6	Protection Rules for VHT STAs.....	156
9.25	Reverse Direction Protocol.....	156
9.25.1	Reverse direction (RD) exchange sequence.....	156
9.25.3	Rules for RD initiator.....	157
9.25.4	Rules for responder.....	157
9.26	PSMP operation.....	157
9.26.1	Frame transmission mechanism during PSMP.....	157

9.26.1.2	PSMP downlink transmission (PSMP-DTT).....	157
9.27	Sounding PPDU.....	158
9.28	Link adaptation.....	158
9.28.2	Link adaptation using the <u>HT variant</u> HT Control field.....	158
9.28.3	Link adaptation using the <u>VHT variant</u> HT Control field.....	159
9.29	Transmit beamforming.....	162
9.29.1	General <u>HT steering matrix calculations</u>	162
9.29.2	<u>HT</u> transmit beamforming with implicit feedback.....	162
9.29.2.1	General.....	162
9.29.2.3	Bidirectional implicit transmit beamforming.....	164
9.29.2.4	Calibration.....	164
9.29.3	Explicit feedback beamforming.....	164
9.29.4	VHT MU beamforming.....	165
9.30	Antenna selection (ASEL).....	165
9.30.1	Introduction.....	165
9.31	Null data packet (NDP) sounding.....	165
9.31.1	NDP rules.....	165
9.31.2	Transmission of an <u>HT</u> NDP.....	167
9.31.3	Determination of <u>HT</u> NDP destination.....	167
9.31.4	Determination of <u>HT</u> NDP source.....	167
9.31.5	VHT sounding protocol.....	168
9.31.5.1	General.....	168
9.31.5.2	Rules for VHT sounding protocol sequences.....	168
9.31.5.3	Rules for fragmented feedback in VHT sounding protocol sequences.....	172
9.31.6	Transmission of a VHT NDP.....	173
10.	MLME.....	174
10.1	Synchronization.....	174
10.1.3	Maintaining synchronization.....	174
10.1.3.2	Beacon generation in non-DMG infrastructure networks.....	174
10.2	Power management.....	174
10.2.1	Power management in a non-DMG infrastructure network.....	174
10.2.1.17	TIM broadcast.....	174
10.2.1.19	VHT TXOP power save.....	175
10.3	STA authentication and association.....	176
10.3.5	Association, reassociation, and disassociation.....	176
10.3.5.3	PCP/AP association receipt procedures.....	176
10.3.5.5	PCP/AP reassociation receipt procedures.....	176
10.8	TPC procedures.....	176
10.8.2	Association based on transmit power capability.....	176
10.8.3a	Interpretation of transmit power capability.....	177
10.8.4	Specification of regulatory and local maximum transmit power levels.....	177
10.9	DFS procedures.....	178
10.9.3	Quieting channels for testing.....	178
10.11	Radio measurement procedures.....	179
10.11.9	Specific measurement usage.....	179
10.11.9.1	Beacon Report.....	179
10.11.9.3	Channel Load Report.....	180
10.11.9.4	Noise Histogram Report.....	181
10.11.18	AP Channel Report.....	181
10.15	20/40 MHz BSS operation.....	181
10.15.2	Basic 20/40 MHz BSS functionality.....	181
10.15.8	Support for DSSS/CCK in 40 MHz.....	182

10.15.9	STA CCA sensing in a 20/40 MHz BSS	182
10.15.12	Switching between 40 MHz and 20 MHz	182
10.16	Phased coexistence operation (PCO)	182
10.16.1	General description of PCO	182
10.17	20/40 BSS Coexistence Management frame usage	183
10.22	Tunneled direct link setup	183
10.22.1	General	183
10.22.6	TDLS channel switching	184
10.22.6.3	TDLS channel switching and power saving	184
10.22.6.4	Setting up a wide bandwidth off-channel direct link	184
10.25	Quality-of-Service management frame (QMF)	185
10.25.1	General	185
10.25.1.2	Default QMF policy	185
10.39	VHT BSS operation	186
10.39.1	Basic VHT BSS functionality	186
10.39.2	Channel selection methods for a VHT BSS	187
10.39.3	Scanning requirements for VHT STA	188
10.39.4	Channel switching methods for a VHT BSS	188
10.39.5	NAV assertion in a VHT BSS	191
10.39.6	VHT STA antenna indication	191
10.39.7	BSS basic VHT-MCS and NSS set operation	191
10.40	Group ID management operation	191
10.41	Notification of operating mode changes	192
11.	Security	195
11.4	RSNA confidentiality and integrity protocols	195
11.4.3	CTR with CBC-MAC Protocol (CCMP)	195
11.4.3.1	General	195
11.4.3.2	CCMP MPDU format	195
11.4.3.3	CCMP cryptographic encapsulation	196
11.4.3.4	CCMP decapsulation	196
11.4.4	Broadcast/Multicast Integrity Protocol (BIP)	196
11.4.4.1	BIP overview	196
11.4.4.5	BIP transmission	197
11.4.4.6	BIP reception	197
11.4.5	GCM with Galois Message Authentication Code (GMAC) Protocol (GCMP)	198
11.4.5.1	GCMP overview	198
11.5	RSNA security association management	198
11.5.3	RSNA policy selection in an ESS	198
11.5.5	RSNA policy selection in an IBSS and for DLS	198
11.5.7	RSNA policy selection in an MBSS	199
11.6	Keys and key distribution	199
11.6.1	Key hierarchy	199
11.6.1.2	PRF	199
11.6.1.3	Pairwise key hierarchy	200
11.6.1.7	FT key hierarchy	202
11.6.2	EAPOL-Key frames	204
11.6.3	EAPOL-Key frame construction and processing	205
11.7	Mapping EAPOL keys to IEEE 802.11 keys	205
11.7.7	Mapping IGTK to BIP keys	205
13.	MLME mesh procedures	206

13.2	Mesh discovery	206
13.2.4	Mesh STA configuration	206
13.2.7	Candidate peer mesh STA	206
18.	Orthogonal frequency division multiplexing (OFDM) PHY specification	207
18.2	OFDM PHY specific service parameter list	207
18.2.2	TXVECTOR parameters	207
18.2.2.1	General.....	207
18.2.2.7	TXVECTOR CH_BANDWIDTH_IN_NON_HT	207
18.2.2.8	TXVECTOR DYN_BANDWIDTH_IN_NON_HT	207
18.2.3	RXVECTOR parameters	208
18.2.3.1	General.....	208
18.2.3.7	RXVECTOR CH_BANDWIDTH_IN_NON_HT	208
18.2.3.8	RXVECTOR DYN_BANDWIDTH_IN_NON_HT	208
18.3	OFDM PLCP sublayer.....	208
18.3.2	PLCP frame format.....	208
18.3.2.2	Overview of the PPDU encoding process	208
18.3.5	DATA field.....	209
18.3.5.5	PLCP DATA scrambler and descrambler	209
18.3.9	PMD transmit specifications	211
18.3.9.3	Transmit spectrum mask.....	211
18.3.9.7	Modulation accuracy	211
19.	Extended Rate PHY (ERP) specification	212
19.3	Extended Rate PLCP sublayer.....	212
19.3.3	PLCP data modulation and rate change.....	212
19.3.3.4	Long and short DSSS-OFDM PLCP format	212
20.	High Throughput (HT) PHY specification.....	213
20.1	Introduction.....	213
20.1.1	Introduction to the HT PHY	213
20.3	HT PLCP sublayer.....	213
20.3.10	Transmission of NON_HT format PPDU with more than one antenna transmit chain.....	213
20.3.11	Data field	213
20.3.11.3	Scrambler.....	213
20.3.20	PMD transmit specification.....	213
20.3.20.1	Transmit spectrum mask.....	213
20.3.20.7	Modulation accuracy	213
22.	Very High Throughput (VHT) PHY specification.....	214
22.1	Introduction.....	214
22.1.1	Introduction to the VHT PHY	214
22.1.2	Scope	215
22.1.3	VHT PHY functions	215
22.1.3.1	General.....	215
22.1.3.2	PHY management entity (PLME)	215
22.1.3.3	Service specification method.....	215
22.1.4	PPDU formats.....	215
22.2	VHT PHY service interface.....	216

22.2.1	Introduction	216
22.2.2	TXVECTOR and RXVECTOR parameters	216
22.2.3	Effects of CH_BANDWIDTH parameter on PPDU format	224
22.2.4	Support for NON_HT and HT formats.....	226
22.2.4.1	General.....	226
22.2.4.2	Support for NON_HT format when NON_HT_MODULATION is OFDM.....	228
22.2.4.3	Support for HT formats	229
22.3	VHT PHY layer	229
22.3.1	Introduction	229
22.3.2	VHT PPDU format	229
22.3.3	Transmitter block diagram.....	230
22.3.4	Overview of the PPDU encoding process	234
22.3.4.1	General.....	234
22.3.4.2	Construction of L-STF.....	234
22.3.4.3	Construction of the L-LTF	235
22.3.4.4	Construction of L-SIG	236
22.3.4.5	Construction of VHT-SIG-A	237
22.3.4.6	Construction of VHT-STF.....	238
22.3.4.7	Construction of VHT-LTF.....	239
22.3.4.8	Construction of VHT-SIG-B	241
22.3.4.9	Construction of the Data field in a VHT SU PPDU	241
22.3.4.10	Construction of the Data field in a VHT MU PPDU.....	243
22.3.5	VHT modulation and coding scheme (VHT-MCS)	243
22.3.6	Timing-related parameters.....	244
22.3.7	Mathematical description of signals	247
22.3.7.1	Notation	247
22.3.7.2	Subcarrier indices in use.....	247
22.3.7.3	Channel frequencies	248
22.3.7.4	Transmitted signal	249
22.3.7.5	Definition of tone rotation	253
22.3.8	VHT preamble	254
22.3.8.1	Introduction	254
22.3.8.2	Non-VHT portion of VHT format preamble	254
22.3.8.3	VHT portion of VHT format preamble	258
22.3.9	Transmission of NON_HT and HT PPDUs with multiple transmit chains.....	272
22.3.9.1	Transmission of 20 MHz NON_HT PPDUs with more than one transmit chain	272
22.3.9.2	Transmission of HT PPDUs with more than four transmit chains	272
22.3.10	Data field	272
22.3.10.1	General.....	272
22.3.10.2	SERVICE field	273
22.3.10.3	CRC calculation for VHT-SIG-B	273
22.3.10.4	Scrambler.....	274
22.3.10.5	Coding	274
22.3.10.6	Stream parser	277
22.3.10.7	Segment parser	278
22.3.10.8	BCC interleaver	279
22.3.10.9	Constellation mapping	282
22.3.10.10	Pilot subcarriers	289
22.3.10.11	OFDM modulation	291
22.3.10.12	Non-HT duplicate transmission.....	292
22.3.11	SU-MIMO and DL-MU-MIMO Beamforming.....	293
22.3.11.1	General.....	293

22.3.11.2	Beamforming Feedback Matrix V	294
22.3.11.3	Maximum Number of Total Spatial Streams in VHT MU PPDUs	294
22.3.11.4	Group ID	295
22.3.12	VHT preamble format for sounding PPDUs	295
22.3.13	Regulatory requirements	296
22.3.14	Channelization	296
22.3.15	Transmit RF delay	297
22.3.16	Slot time	297
22.3.17	Transmit and receive port impedance	297
22.3.18	VHT transmit specification	298
22.3.18.1	Transmit spectrum mask	298
22.3.18.2	Spectral flatness	301
22.3.18.3	Transmit center frequency and symbol clock frequency tolerance	303
22.3.18.4	Modulation accuracy	303
22.3.18.5	Time of Departure accuracy	305
22.3.19	VHT receiver specification	306
22.3.19.1	Receiver minimum input sensitivity	306
22.3.19.2	Adjacent channel rejection	306
22.3.19.3	Nonadjacent channel rejection	307
22.3.19.4	Receiver maximum input level	308
22.3.19.5	CCA sensitivity	308
22.3.19.6	RSSI	310
22.3.20	PHY transmit procedure	310
22.3.21	PHY receive procedure	313
22.4	VHT PLME	318
22.4.1	PLME_SAP sublayer management primitives	318
22.4.2	PHY MIB	318
22.4.3	TXTIME and PSDU_LENGTH calculation	321
22.4.4	PHY characteristics	323
22.5	Parameters for VHT-MCSs	323
Annex B (normative) Protocol Implementation Conformance Statement (PICS) proforma		340
B.2	Abbreviations and special symbols	340
B.2.2	General abbreviations for Item and Support columns	340
B.4	PICS proforma—IEEE Std 802.11-<year>	340
B.4.3	HT configuration	340
B.4.4	MAC protocol	341
B.4.4.1	MAC protocol capabilities	341
B.4.4.2	MAC frames	341
B.4.12	Spectrum management extensions	342
B.4.18	DSE functions	343
B.4.19	High-throughput (HT) features	345
B.4.19.1	HT MAC features	345
B.4.27	Very high throughput (VHT) features	346
B.4.27.1	VHT MAC features	346
B.4.27.2	VHT PHY features	348
Annex C (normative) ASN.1 encoding of the MAC and PHY MIB		353
C.3	MIB Detail	353
Annex D (normative) Regulatory references		374

D.1	External regulatory references	374
D.2	Radio performance specifications.....	375
D.2.5	CCA-ED threshold	375
Annex E (normative)	Country elements and operating classes	376
E.1	Country information and operating classes	376
E.2	Band-specific operating requirements	382
E.2.2	3650–3700 MHz in the United States	382
Annex G (normative)	Frame exchange sequences.....	383
G.1	General.....	383
G.4	HT and VHT sequences	384
Annex M (informative)	RSNA reference implementations and test vectors.....	388
M.6	Additional test vectors	388
M.6.4	CCMP-128 test vector.....	388
M.7	Key hierarchy test vectors for pairwise keys	389
M.7.1	General	389
M.7.2	CCMP-128 pairwise key derivation.....	389
M.9	Management frame protection test vectors	389
M.9.1	BIP-CMAC-128 with broadcast Deauthentication frame	389
M.9.2	CCMP-128 with unicast Deauthentication frame	390
M.11	GCMP	391
M.11.1	Test vector	391
Annex S (informative)	Additional VHT and HT Information.....	392
S.1	VHT and HT waveform generator tool.....	392
S.4	Illustration of determination of NDP addresses.....	392
Annex T (informative)	Location and Time Difference accuracy test.....	393
T.2	Time Difference of departure accuracy test.....	393
Annex V (informative)	Interworking with external networks	394
V.2	Network discovery and selection	394
V.2.4	Sales meeting.....	394
Annex W (informative)	Mesh BSS operation.....	395
W.1	Clarification of Mesh Data frame format	395

Tables

Table 7-4—Vector descriptions	28
Table 7-5—The channel-list parameter elements	30
Table 8-0a—Maximum MSDU and A-MSDU sizes	33
Table 8-1—Valid type and subtype combinations	33
Table 8-6—Ack Policy subfield in QoS Control field of QoS data frames	34
Table 8-9—ASEL Command and ASEL Data subfields	36
Table 8-13a—VHT variant HT Control field subfields	37
Table 8-13b—MFB subfield in the VHT variant HT Control field	39
Table 8-13c—Maximum data unit sizes (in octets) and durations (in microseconds)	40
Table 8-18a—STA Info subfields	45
Table 8-20—Beacon frame body	47
Table 8-22—Association Request frame body	48
Table 8-23—Association Response frame body	48
Table 8-24—Reassociation Request frame body	49
Table 8-25—Reassociation Response frame body	49
Table 8-26—Probe Request frame body	49
Table 8-27—Probe Response frame body	50
Table 8-37—Status codes	51
Table 8-38—Category values	51
Table 8-53c—Subfields of the VHT MIMO Control field	54
Table 8-53d—Order of angles in the Compressed Beamforming Feedback Matrix subfield	55
Table 8-53e—Quantization of angles	57
Table 8-53f—VHT Compressed Beamforming Report information	58
Table 8-53g—Subcarriers for which a Compressed Beamforming Feedback Matrix subfield is sent back	59
Table 8-53h—Average SNR of Space-Time Stream <i>i</i> subfield	64
Table 8-53i—MU Exclusive Beamforming Report information	65
Table 8-53j—Number of subcarriers and subcarrier mapping	66
Table 8-53k—Subfield values of the Operating Mode field	69
Table 8-53l—Encoding of User Position subfield	70
Table 8-54—Element IDs	71
Table 8-55—BSS membership selector value encoding	71
Table 8-60—Optional subelement IDs for Channel Load Request	76
Table 8-62—Optional subelement IDs for Noise Histogram Request	77
Table 8-65—Optional subelement IDs for Beacon Report	78
Table 8-68—Optional subelement IDs for frame request	79
Table 8-83—Optional subelement IDs for Channel Load Report	80
Table 8-85—Optional subelement IDs for Noise Histogram Report	81
Table 8-87—Optional subelement IDs for Frame Report	82
Table 8-99—Cipher suite selectors	83
Table 8-100—Cipher suite usage	83
Table 8-101—AKM suite selectors	84
Table 8-103—Capabilities field	84
Table 8-105—Default EDCA Parameter Set element parameter values if dot11OCBAActivated is false	85
Table 8-115—Optional subelement IDs for neighbor report	86
Table 8-124—Subfields of the HT Capabilities Info field	89
Table 8-127—Subfields of the HT Extended Capabilities field	90
Table 8-128—Subfields of the Transmit Beamforming Capabilities field	90
Table 8-130—HT Operation element fields and subfields	91
Table 8-147—Power Save Mode definition	92
Table 8-183v—Subfields of the VHT Capabilities Info field	94
Table 8-183w—Supported VHT-MCS and NSS Set subfields	97
Table 8-183x—VHT Operation Information subfields	99

Table 8-183y—Meaning of Local Maximum Transmit Power Count subfield	102
Table 8-183z—Definition of Local Maximum Transmit Power Unit Interpretation subfield	102
Table 8-199—DLS Request frame Action field format	106
Table 8-200—DLS Response frame Action field format	106
Table 8-220—Information for TDLS Discovery Response frame	107
Table 8-239—Information for TDLS Setup Request frame	108
Table 8-240—Information for TDLS Setup Response frame	108
Table 8-241—Information for TDLS Setup Confirm frame	109
Table 8-244—Information for TDLS Channel Switch Request frame.....	109
Table 8-262—Mesh Peering Open frame Action field format	110
Table 8-263—Mesh Peering Confirm frame Action field format	111
Table 8-281ah—VHT Action field values.....	111
Table 8-281ai—VHT Compressed Beamforming frame Action field format.....	112
Table 8-281aj—Group ID Management frame Action field format.....	112
Table 8-281ak—Operating Mode Notification frame Action field format	113
Table 8-282—MPDU delimiter fields	115
Table 8-282a—MPDU delimiter fields (DMG)	115
Table 8-283—A-MPDU Contexts	117
Table 8-288—A-MPDU contents in the VHT single MPDU context.....	117
Table 9-3—CH_BANDWIDTH control frame response mapping	132
Table 9-4—Modulation classes	134
Table 9-5—Non-HT reference rate.....	135
Table 9-5a—Example of rate selection for VHT PPDU.....	137
Table 9-5b—Settings for the TXVECTOR parameters GROUP_ID and PARTIAL_AID	145
Table 9-8a—Channels indicated idle by the channel-list parameter	154
Table 9-9—Transmit beamforming support required with implicit feedback.....	163
Table 10-12—Default QMF policy	185
Table 10-19—VHT BSS operating channel width	186
Table 11-4—Cipher suite key lengths	204
Table 11-9—Integrity and key-wrap algorithms	205
Table 18-1—TXVECTOR parameters	207
Table 18-2—RXVECTOR parameters.....	208
Table 18-6a—Contents of the first 7 bits of the scrambling sequence	210
Table 18-6b—TXVECTOR parameter CH_BANDWIDTH_IN_NON_HT values	211
Table 18-6c—RXVECTOR parameter CH_BANDWIDTH_IN_NON_HT values	211
Table 18-6d—DYN_BANDWIDTH_IN_NON_HT values	211
Table 22-1—TXVECTOR and RXVECTOR parameters.....	216
Table 22-2—PPDU format as a function of CH_BANDWIDTH parameter	224
Table 22-3—Mapping of the VHT PHY parameters for NON_HT operation.....	228
Table 22-4—Fields of the VHT PPDU.....	230
Table 22-5—Timing-related constants	244
Table 22-6—Frequently used parameters.....	245
Table 22-7—Center frequency of the portion of the PPDU transmitted in frequency segment iSeg.....	250
Table 22-8—Tone scaling factor and guard interval duration values for PHY fields	252
Table 22-9—CH_BANDWIDTH and	253
Table 22-10—Cyclic shift values for L-STF, L-LTF, L-SIG, and VHT-SIG-A fields of the PPDU.....	254
Table 22-11—Cyclic shift values for the VHT modulated fields of a PPDU	258
Table 22-12—Fields in the VHT-SIG-A field.....	260
Table 22-13—Number of VHT-LTFs required for different numbers of space-time streams	264
Table 22-14—Fields in the VHT-SIG-B field.....	268
Table 22-15—VHT-SIG-B bits (before Tail field) in NDP for various channel widths	269
Table 22-16—SERVICE field	273
Table 22-17—Number of rows and columns in the interleaver	280
Table 22-18—J(iSS) values	281

Table 22-19—LDPC tone mapping distance for each bandwidth	287
Table 22-20—Constellation mapper output to spatial mapper input for STBC	288
Table 22-21—Pilot values for 80 MHz transmission	290
Table 22-22—Fields to specify VHT channels	296
Table 22-23—Maximum transmit spectral flatness deviations	302
Table 22-24—Allowed relative constellation error versus constellation size and coding rate.....	304
Table 22-25—Receiver minimum input level sensitivity	306
Table 22-26—Minimum required adjacent and nonadjacent channel rejection levels.....	307
Table 22-27—Conditions for CCA BUSY on the primary 20 MHz	309
Table 22-28—VHT PHY MIB attributes	318
Table 22-29—VHT PHY characteristics	323
Table 22-30—VHT-MCSs for mandatory 20 MHz, NSS = 1	324
Table 22-31—VHT-MCSs for optional 20 MHz, NSS = 2	324
Table 22-32—VHT-MCSs for optional 20 MHz, NSS = 3	325
Table 22-33—VHT-MCSs for optional 20 MHz, NSS = 4	325
Table 22-34—VHT-MCSs for optional 20 MHz, NSS = 5	326
Table 22-35—VHT-MCSs for optional 20 MHz, NSS = 6	326
Table 22-36—VHT-MCSs for optional 20 MHz, NSS = 7	327
Table 22-37—VHT-MCSs for optional 20 MHz, NSS = 8	327
Table 22-38—VHT-MCSs for mandatory 40 MHz, NSS = 1	328
Table 22-39—VHT-MCSs for optional 40 MHz, NSS = 2	328
Table 22-40—VHT-MCSs for optional 40 MHz, NSS = 3	329
Table 22-41—VHT-MCSs for optional 40 MHz, NSS = 4	329
Table 22-42—VHT-MCSs for optional 40 MHz, NSS = 5	330
Table 22-43—VHT-MCSs for optional 40 MHz, NSS = 6	330
Table 22-44—VHT-MCSs for optional 40 MHz, NSS = 7	331
Table 22-45—VHT-MCSs for optional 40 MHz, NSS = 8	331
Table 22-46—VHT-MCSs for mandatory 80 MHz, NSS = 1	332
Table 22-47—VHT-MCSs for optional 80 MHz, NSS = 2	332
Table 22-48—VHT-MCSs for optional 80 MHz, NSS = 3	333
Table 22-49—VHT-MCSs for optional 80 MHz, NSS = 4	333
Table 22-50—VHT-MCSs for optional 80 MHz, NSS = 5	334
Table 22-51—VHT-MCSs for optional 80 MHz, NSS = 6	334
Table 22-52—VHT-MCSs for optional 80 MHz, NSS = 7	335
Table 22-53—VHT-MCSs for optional 80 MHz, NSS = 8	335
Table 22-54—VHT-MCSs for optional 160 MHz and 80+80 MHz, NSS = 1	336
Table 22-55—VHT-MCSs for optional 160 MHz and 80+80 MHz, NSS = 2	336
Table 22-56—VHT-MCSs for optional 160 MHz and 80+80 MHz, NSS = 3	337
Table 22-57—VHT-MCSs for optional 160 MHz and 80+80 MHz, NSS = 4	337
Table 22-58—VHT-MCSs for optional 160 MHz and 80+80 MHz, NSS = 5	338
Table 22-59—VHT-MCSs for optional 160 MHz and 80+80 MHz, NSS = 6	338
Table 22-60—VHT-MCSs for optional 160 MHz and 80+80 MHz, NSS = 7	339
Table 22-61—VHT-MCSs for optional 160 MHz and 80+80 MHz, NSS = 8	339
Table D-1—Regulatory requirement list	374
Table D-2—Behavior limits set	374
Table E-1—Operating classes in the United States	376
Table E-2—Operating classes in Europe	377
Table E-3—Operating classes in Japan	378
Table E-4—Global operating classes	378
Table E-5—Operating classes in China	380
Table G-1—Attributes applicable to frame exchange sequence definition	383
Table M-14—Sample derived CCMP-128 temporal key (TK)	389

Figures

Figure 7-1—The channel-list parameter element for 40 MHz, 80 MHz, and 160 MHz channel width	31
Figure 7-2—The channel-list parameter element for 80+80 MHz channel width	31
Figure 8-1—MAC frame format.....	33
Figure 8-5—HT Control field.....	35
Figure 8-6—Link Adaptation Control subfield	36
Figure 8-5a—HT Control Middle subfield of the HT variant HT Control field	36
Figure 8-8a—HT Control Middle subfield of the VHT variant HT Control field	37
Figure 8-8b—MSI/STBC subfield when the Unsolicited MFB subfield is 1.....	39
Figure 8-8c—MFB subfield in the VHT variant HT Control field	39
Figure 8-29j—VHT NDP Announcement frame format.....	44
Figure 8-29k—Sounding Dialog Token field	44
Figure 8-29l—STA Info field	45
Figure 8-29m—Beamforming Report Poll frame format	45
Figure 8-30—Data frame.....	46
Figure 8-32—Basic A-MSDU subframe structure	46
Figure 8-34—Management frame format.....	47
Figure 8-70a—MCS Index field format when the MCS Selector field is 3, 4, 5, or 6.....	53
Figure 8-80d—VHT MIMO Control field.....	53
Figure 8-80e—Operating Mode field	69
Figure 8-80g—User Position Array field	70
Figure 8-80f—Membership Status Array field.....	70
Figure 8-90—Country element format	72
Figure 8-90a—Subband Triplet Sequence format	72
Figure 8-90b—Subband Triplet field	72
Figure 8-90c—Triplet field if dot11OperaratingClassRequired is true.....	73
Figure 8-90d—Format of m-th Operating/Subband Sequence field	73
Figure 8-216—BSSID Information field.....	86
Figure 8-246—Supported Operating Classes element format	87
Figure 8-246a—Current Operating Class Extension Sequence field format.....	88
Figure 8-246b—Operating Class Duple Sequence field format.....	88
Figure 8-247—Management MIC element format	88
Figure 8-252—HT Extended Capabilities field.....	90
Figure 8-401bp—VHT Capabilities element format	93
Figure 8-401bq—VHT Capabilities Info field	94
Figure 8-401br—Supported VHT-MCS and NSS Set field	97
Figure 8-401bt—VHT Operation element format	98
Figure 8-401bu—VHT Operation Information field.....	98
Figure 8-401bs—Rx VHT-MCS Map and Tx VHT-MCS Map subfields and Basic VHT-MCS and NSS Set field	98
Figure 8-401bv—Extended BSS Load element format.....	99
Figure 8-401bx—VHT Transmit Power Envelope element format	101
Figure 8-401by—Transmit Power Information field.....	101
Figure 8-401bw—Wide Bandwidth Channel Switch element format.....	101
Figure 8-401bz—Channel Switch Wrapper element format	102
Figure 8-401ca—AID element format.....	103
Figure 8-401cb—Quiet Channel element format	104
Figure 8-401cc—Operating Mode Notification element.....	104
Figure 8-436—Channel Switch Announcement frame Action field format.....	105
Figure 8-449—Extended Channel Switch Announcement frame Action field format.....	107
Figure 8-495—Channel Usage Response frame format	110
Figure 8-503—A-MPDU format	113

Figure 8-504—A-MPDU subframe format	114
Figure 8-505—MPDU delimiter (non-DMG)	114
Figure 8-505a—MPDU delimiter (DMG)	114
Figure 8-505a1—MPDU Length field	115
Figure 9-1—MAC architecture	118
Figure 9-9a—An example of a TXOP containing a VHT MU PPDU transmission with an immediate acknowledgment to the VHT MU PPDU	123
Figure 9-9b—An example of a TXOP containing a VHT MU PPDU transmission with no immediate acknowledgment to the VHT MU PPDU	123
Figure 9-20a—Illustration of TXOP sharing and PPDU construction	150
Figure 9-41a—Example of the sounding protocol with a single VHT beamformee	170
Figure 9-41b—Example of the sounding protocol with more than one VHT beamformee	170
Figure 11-16—Expanded CCMP MPDU	195
Figure 18-7—Data scrambler	209
Figure 22-1—PHY interaction on transmit for various PPDU formats	226
Figure 22-2—PHY interaction on receive for various PPDU formats	227
Figure 22-3—PHY-CONFIG and CCA interaction with Clause 18, Clause 20, and Clause 22 PHYs	227
Figure 22-4—VHT PPDU format	229
Figure 22-5—Transmitter block diagram for the L-SIG and VHT-SIG-A fields	231
Figure 22-6—Transmitter block diagram for the VHT-SIG-B field of a 20 MHz, 40 MHz, and 80 MHz VHT SU PPDU	232
Figure 22-7—Transmitter block diagram for the VHT-SIG-B field of a 20 MHz, 40 MHz, and 80 MHz VHT MU PPDU	232
Figure 22-8—Transmitter block diagram for the VHT-SIG-B field of a 160 MHz VHT SU PPDU	233
Figure 22-9—Transmitter block diagram for the VHT-SIG-B field of an 80+80 MHz VHT SU PPDU	233
Figure 22-10—Transmitter block diagram for the Data field of a 20 MHz, 40 MHz, or 80 MHz VHT SU PPDU with BCC encoding	234
Figure 22-11—Transmitter block diagram for the Data field of a 20 MHz, 40 MHz, or 80 MHz VHT SU PPDU with LDPC encoding	235
Figure 22-12—Transmitter block diagram for the Data field of a 20 MHz, 40 MHz, or 80 MHz VHT MU PPDU	236
Figure 22-13—Transmitter block diagram for the Data field of a 160 MHz VHT SU PPDU with BCC encoding	237
Figure 22-14—Transmitter block diagram for the Data field of a 160 MHz VHT SU PPDU with LDPC encoding	238
Figure 22-15—Transmitter block diagram for the Data field of an 80+80 MHz VHT SU PPDU with BCC encoding	239
Figure 22-16—Transmitter block diagram for the Data field of an 80+80 MHz VHT SU PPDU with LDPC encoding	240
Figure 22-17—Timing boundaries for VHT PPDU fields	250
Figure 22-18—VHT-SIG-A1 structure	259
Figure 22-19—VHT-SIG-A2 structure	259
Figure 22-20—Data tone constellation in the VHT PPDU pre-VHT modulated fields	262
Figure 22-21—Generation of VHT-LTF symbols per frequency segment	266
Figure 22-22—VHT-SIG-B bits in 20 MHz, 40 MHz, 80 MHz, 160 MHz, and 80+80 MHz transmissions	269
Figure 22-23—VHT-SIG-B and SERVICE field relationship	273
Figure 22-24—Constellation bit encoding for 256-QAM (1st quadrant)	283
Figure 22-25—Constellation bit encoding for 256-QAM (2nd quadrant)	284
Figure 22-26—Constellation bit encoding for 256-QAM (3rd quadrant)	285
Figure 22-27—Constellation bit encoding for 256-QAM (4th quadrant)	286
Figure 22-28—VHT NDP format	295
Figure 22-29—Example transmit spectral mask for a 20 MHz mask PPDU	298
Figure 22-31—Example transmit spectral mask for an 80 MHz mask PPDU	299

Figure 22-30—Example transmit spectral mask for a 40 MHz mask PPDU 299
 Figure 22-32—Example transmit spectral mask for a 160 MHz mask PPDU 300
 Figure 22-33—Example transmit spectral mask for an 80+80 MHz mask PPDU 301
 Figure 22-34—PHY transmit procedure for an SU transmission 311
 Figure 22-35—PHY transmit state machine for an SU transmission 312
 Figure 22-36—PHY receive procedure for an SU transmission 316
 Figure 22-37—PHY receive state machine 317

IECNORM.COM : Click to view the full PDF of ISO/IEC/IEEE 8802-11:2012/AMD4:2015

IECNORM.COM : Click to view the full PDF of ISO/IEC/IEEE 8802-11:2012/AMD4:2015

IEEE Standard for Information technology—
Telecommunications and information exchange between systems
Local and metropolitan area networks—
Specific requirements

Part 11: Wireless LAN Medium Access Control (MAC) and Physical Layer (PHY) Specifications

Amendment 4: Enhancements for Very High Throughput for Operation in Bands below 6 GHz

IMPORTANT NOTICE: IEEE Standards documents are not intended to ensure safety, health, or environmental protection, or ensure against interference with or from other devices or networks. Implementers of IEEE Standards documents are responsible for determining and complying with all appropriate safety, security, environmental, health, and interference protection practices and all applicable laws and regulations.

This IEEE document is made available for use subject to important notices and legal disclaimers. These notices and disclaimers appear in all publications containing this document and may be found under the heading “Important Notice” or “Important Notices and Disclaimers Concerning IEEE Documents.” They can also be obtained on request from IEEE or viewed at <http://standards.ieee.org/IPR/disclaimers.html>.

(This amendment is based on IEEE Std 802.11™-2012, as amended by IEEE Std 802.11ae™-2012, IEEE Std 802.11aa™-2012, and IEEE Std 802.11ad™-2012.)

NOTE—The editing instructions contained in this amendment define how to merge the material contained therein into the existing base standard and its amendments to form the comprehensive standard. The editing instructions are shown in **bold italic**. Four editing instructions are used: change, delete, insert, and replace. **Change** is used to make corrections in existing text or tables. The editing instruction specifies the location of the change and describes what is being changed by using ~~strike through~~ (to remove old material) and underscore (to add new material). **Delete** removes existing material. **Insert** adds new material without disturbing the existing material. Deletions and insertions may require renumbering. If so, renumbering instructions are given in the editing instruction. **Replace** is used to make changes in figures or equations by removing the existing figure or equation and replacing it with a new one. Editorial instructions, change markings, and this NOTE will not be carried over into future editions because the changes will be incorporated into the base standard.¹

¹Notes in text, tables, and figures are given for information only and do not contain requirements needed to implement the standard.

3. Definitions, acronyms and abbreviations

3.1 Definitions

Delete the following definition from 3.1 (note that the definition is inserted with changes into 3.2):

medium access control (MAC) management protocol data unit (MMPDU)

Insert the following definitions into 3.1 in alphabetic order:

aggregate medium access control (MAC) protocol data unit (A-MPDU) subframe: A portion of an A-MPDU containing a delimiter and optionally containing an MPDU plus any necessary padding.

contiguous transmission: A transmission that uses only one frequency segment.

downlink multi-user multiple input, multiple output (DL-MU-MIMO): A technique by which an access point (AP) with more than one antenna transmits a physical layer (PHY) protocol data unit (PPDU) to multiple receiving non-AP stations (STAs) over the same radio frequencies, wherein each non-AP STA simultaneously receives one or more distinct space-time streams.

frequency segment: A contiguous block of spectrum used by a transmission.

multi-user multiple input, multiple output (MU-MIMO): A technique by which multiple stations (STAs), each with one or more antennas, either simultaneously transmit to a single STA or simultaneously receive from a single STA independent data streams over the same radio frequencies.

NOTE—IEEE 802.11 supports only downlink (DL) MU-MIMO. See DL-MU-MIMO.

multi-user (MU) physical layer (PHY) protocol data unit (PPDU): A PPDU that carries one or more PHY service data units (PSDUs) for one or more stations (STAs) using the downlink multi-user multiple input, multiple output (DL-MU-MIMO) technique.

noncontiguous transmission: A transmission that uses nonadjacent frequency segments.

single-user (SU) physical layer (PHY) protocol data unit (PPDU): A PPDU with a format that is capable of carrying only a single PHY service data unit (PSDU), or no PSDU.

3.2 Definitions specific to IEEE 802.11

Change the following definitions in 3.2:

20 MHz mask physical layer (PHY) convergence procedure (PLCP)-protocol data unit (PPDU): A Clause 18 PPDU, a Clause 19 orthogonal frequency division multiplexing (OFDM) PPDU, or a Clause 20 20 MHz high throughput (HT) PPDU with the TXVECTOR parameter CH_BANDWIDTH equal to HT_CBW20 and the CH_OFFSET parameter equal to CH_OFF_20. The PPDU is transmitted using a 20 MHz transmit spectral mask defined in Clause 18, Clause 19, or Clause 20. One of the following PPDUs:

- a) A Clause 18 PPDU transmitted using the transmit spectral mask defined in Clause 18.
- b) A Clause 19 orthogonal frequency division multiplexing (OFDM) PPDU transmitted using the transmit spectral mask defined in Clause 19.

- c) A high-throughput (HT) PPDU with the TXVECTOR parameter CH_BANDWIDTH equal to HT_CBW20 and the CH_OFFSET parameter equal to CH_OFF_20 transmitted using the 20 MHz transmit spectral mask defined in Clause 20.
- d) A very high throughput (VHT) PPDU with TXVECTOR parameter CH_BANDWIDTH equal to CBW20 transmitted using the 20 MHz transmit spectral mask defined in Clause 22.
- e) A Clause 18 PPDU transmitted by a VHT STA using the transmit spectral mask defined in Clause 22.
- f) A HT PPDU with the TXVECTOR parameter CH_BANDWIDTH equal to HT_CBW20 and the CH_OFFSET parameter equal to CH_OFF_20 transmitted by a VHT STA using the 20 MHz transmit spectral mask defined in Clause 22.

20 MHz physical layer (PHY) convergence procedure (PLCP)-protocol data unit (PPDU): A Clause 16 PPDU, Clause 18 PPDU (when using 20 MHz channel spacing), Clause 17 PPDU, Clause 19 orthogonal frequency division multiplexing (OFDM) PPDU, ~~or~~ Clause 20 20 MHz high-throughput (HT) PPDU with the TXVECTOR parameter CH_BANDWIDTH equal to HT_CBW20 ~~or~~ Clause 22 20 MHz very high throughput (VHT) PPDU with the TXVECTOR parameter CH_BANDWIDTH equal to CBW20.

40 MHz mask physical layer (PHY) convergence procedure (PLCP)-protocol data unit (PPDU): One of the following PPDUs:

- 1) ~~a~~ A 40 MHz high-throughput (HT) PPDU (TXVECTOR parameter CH_BANDWIDTH equal to HT_CBW40) transmitted using the 40 MHz transmit spectral mask defined in Clause 20.
- 2) ~~a~~ 40 MHz non-HT duplicate PPDU (TXVECTOR parameter CH_BANDWIDTH equal to NON_HT_CBW40) transmitted by a non-very-high-throughput (non-VHT) STA using the 40 MHz transmit spectral mask defined in Clause 20.
- 3) A 40 MHz non-HT duplicate PPDU (TXVECTOR parameter CH_BANDWIDTH equal to CBW40) transmitted by a very high throughput (VHT) STA using the 40 MHz transmit spectral mask defined in Clause 22.
- 4) ~~a~~ Clause 20 A 20 MHz HT PPDU with the TXVECTOR parameter CH_BANDWIDTH equal to HT_CBW20 and the CH_OFFSET parameter equal to either CH_OFF_20U or CH_OFF_20L transmitted using the 40 MHz transmit spectral mask defined in Clause 20.
- 5) A 20 MHz VHT PPDU with the TXVECTOR parameter CH_BANDWIDTH equal to CBW20 transmitted using the 40 MHz transmit spectral mask defined in Clause 22.
- 6) A 40 MHz VHT PPDU with the TXVECTOR parameter CH_BANDWIDTH equal to CBW40 transmitted using the 40 MHz transmit spectral mask defined in Clause 22.
- 7) A 40 MHz HT PPDU (TXVECTOR parameter CH_BANDWIDTH equal to HT_CBW40) transmitted by a VHT STA using the 40 MHz transmit spectral mask defined in Clause 22.
- 8) A 20 MHz non-HT PPDU (TXVECTOR parameter CH_BANDWIDTH equal to CBW20) transmitted using the 40 MHz transmit spectral mask defined in Clause 20.
- 9) A 20 MHz non-HT PPDU (TXVECTOR parameter CH_BANDWIDTH equal to CBW20) transmitted by a VHT STA using the 40 MHz transmit spectral mask defined in Clause 22.

The PPDU is transmitted using a 40 MHz transmit spectral mask defined in Clause 20 (High Throughput (HT) PHY specification).

40 MHz physical layer (PHY) convergence procedure (PLCP)-protocol data unit (PPDU): A 40 MHz high-throughput (HT) PPDU (TXVECTOR parameter CH_BANDWIDTH equal to HT_CBW40), or a 40 MHz non-HT duplicate PPDU (TXVECTOR parameter CH_BANDWIDTH equal to NON_HT_CBW40 or TXVECTOR parameter CH_BANDWIDTH equal to CBW40) as defined in Clause 20, or a 40 MHz very high throughput (VHT) PPDU (TXVECTOR parameter CH_BANDWIDTH equal to CBW40).

high-throughput (HT) null data packet (NDP) announcement: A physical layer (PHY) ~~convergence procedure (PLCP)~~-protocol data unit (PPDU) that contains one or more +HTC frames (i.e., frames with an HT (high-throughput) Control field) that have the HT NDP Announcement subfield equal to 1.

modulation and coding scheme (MCS): A specification of the ~~high-throughput (HT)~~ physical layer (PHY) parameters that consists of modulation order (e.g., BPSK, QPSK, 16-QAM, 64-QAM, and 256-QAM) and forward error correction (FEC) coding rate (e.g., 1/2, 2/3, 3/4, 5/6) and, depending on the context, the number of space-time streams.

non-high-throughput (non-HT) duplicate: A transmission format of the physical layer (PHY) that duplicates a 20 MHz non-HT transmission in two ~~adjacent or more~~ 20 MHz channels and allows a station (STA) in a non-HT basic service set (BSS) on ~~either channel~~ any one of the 20 MHz channels to receive the transmission. A non-HT duplicate format is one of the following:

- 1) 40 MHz non-HT duplicate: A transmission format of the PHY that replicates a 20 MHz non-HT transmission in two adjacent 20 MHz channels.
- 2) 80 MHz non-HT duplicate: A transmission format of the PHY that replicates a 20 MHz non-HT transmission in four adjacent 20 MHz channels.
- 3) 160 MHz non-HT duplicate: A transmission format of the PHY that replicates a 20 MHz non-HT transmission in eight adjacent 20 MHz channels.
- 4) 80+80 MHz non-HT duplicate: A transmission format of the PHY that replicates a 20 MHz non-HT transmission in two frequency segments of four adjacent 20 MHz channels where the two frequency segments of channels are not adjacent.

non-high-throughput (non-HT) duplicate physical layer (PHY) ~~convergence procedure (PLCP)~~ protocol data unit (PPDU): A PPDU transmitted by a Clause 20 or Clause 22 ~~physical layer (PHY)~~ with the TXVECTOR FORMAT parameter equal to NON_HT and the CH_BANDWIDTH parameter equal to NON_HT_CBW40, CBW40, CBW80, CBW160, or CBW80+80.

non-high-throughput (non-HT) physical layer (PHY) ~~convergence procedure (PLCP)~~ protocol data unit (PPDU): A Clause 20 or Clause 22 ~~physical layer (PHY)~~-PPDU with the TXVECTOR FORMAT parameter equal to NON_HT.

payload protected (PP) aggregate medium access control (MAC) service data unit (A-MSDU): An A-MSDU that is protected with CTR with CBC-MAC Protocol (CCMP) or Galois Counter Mode Protocol (GCMP) but does not include the A-MSDU Present field (bit 7 of the QoS Control field) in the construction of the additional authentication data (AAD).

per-frame sequence counter: For Temporal Key Integrity Protocol (TKIP), the counter that is used as the nonce in the derivation of the per-frame encryption key. For Counter mode with Cipher-block chaining Message authentication code Protocol (CCMP) or Galois Counter Mode Protocol (GCMP), the per-frame initialization vector (IV).

robust-security-network-association- (RSNA-) capable equipment: A device that contains a station (STA) that is able to create RSNAs. Such a device might use pre-RSNAs because of configuration. Notice that RSNA-capable does not imply full compliance with the RSNA Protocol Implementation Conformance Statement (PICS). A legacy device that has been upgraded to support Temporal Key Integrity Protocol (TKIP) might be RSNA-capable, but is not compliant with the PICS if it does not also support Counter mode with Cipher-block chaining Message authentication code Protocol (CCMP) using CCMP-128.

secondary channel: A 20 MHz channel associated with a primary channel used by high-throughput (HT) stations (STAs) for the purpose of creating a 40 MHz channel or used by very high throughput (VHT) stations (STAs) for the purpose of creating the primary 40 MHz channel.

signaling and payload protected (SPP) aggregate medium access control (MAC) service data unit (A-MSDU): An A-MSDU that is protected with CTR with CBC-MAC Protocol (CCMP) or Galois Counter Mode Protocol (GCMP) and that includes the A-MSDU Present field (bit 7 of the QoS Control field) in the construction of the additional authentication data (AAD).

Insert the following definitions in 3.2 in alphabetic order:

80 MHz mask physical layer (PHY) protocol data unit (PPDU): A PPDU that is transmitted using the 80 MHz transmit spectral mask defined in Clause 22 and that is one of the following:

- a) An 80 MHz very high throughput (VHT) PPDU (TXVECTOR parameter CH_BANDWIDTH equal to CBW80)
- b) An 80 MHz non-high-throughput (non-HT) duplicate PPDU (TXVECTOR parameter CH_BANDWIDTH equal to CBW80)
- c) A 20 MHz non-HT, high-throughput (HT), or VHT PPDU (TXVECTOR parameter CH_BANDWIDTH equal to CBW20)
- d) A 40 MHz non-HT duplicate, HT, or VHT PPDU (TXVECTOR parameter CH_BANDWIDTH equal to CBW40)

80 MHz physical layer (PHY) protocol data unit (PPDU): A Clause 22 80 MHz very high throughput (VHT) PPDU (TXVECTOR parameter CH_BANDWIDTH equal to CBW80) or a Clause 22 80 MHz non-high-throughput (non-HT) duplicate PPDU (TXVECTOR parameter CH_BANDWIDTH equal to CBW80).

160 MHz mask physical layer (PHY) protocol data unit (PPDU): A PPDU that is transmitted using the 160 MHz transmit spectral mask defined in Clause 22 and that is one of the following:

- a) A 160 MHz very high throughput (VHT) PPDU (TXVECTOR parameter CH_BANDWIDTH set to CBW160)
- b) A 160 MHz non-high-throughput (non-HT) duplicate PPDU (TXVECTOR parameter CH_BANDWIDTH equal to CBW160)
- c) A 20 MHz non-HT, high-throughput (HT), or VHT PPDU (TXVECTOR parameter CH_BANDWIDTH equal to CBW20)
- d) A 40 MHz non-HT duplicate, HT, or VHT PPDU (TXVECTOR parameter CH_BANDWIDTH equal to CBW40)
- e) An 80 MHz non-HT duplicate or VHT PPDU (TXVECTOR parameter CH_BANDWIDTH equal to CBW80)

160 MHz physical layer (PHY) protocol data unit (PPDU): A Clause 22 160 MHz very high throughput (VHT) PPDU (TXVECTOR parameter CH_BANDWIDTH equal to CBW160) or a Clause 22 160 MHz non-high-throughput (non-HT) duplicate PPDU (TXVECTOR parameter CH_BANDWIDTH equal to CBW160).

80+80 MHz mask physical layer (PHY) protocol data unit (PPDU): A PPDU that is transmitted using the 80+80 MHz transmit spectral mask defined in Clause 22 and that is one of the following:

- a) An 80+80 MHz very high throughput (VHT) PPDU (TXVECTOR parameter CH_BANDWIDTH set to CBW80+80)
- b) An 80+80 MHz non-high-throughput (non-HT) duplicate PPDU (TXVECTOR parameter CH_BANDWIDTH set to CBW80+80)

80+80 MHz physical layer (PHY) protocol data unit (PPDU): A Clause 22 80+80 MHz very high throughput (VHT) PPDU (TXVECTOR parameter CH_BANDWIDTH equal to CBW80+80) or a Clause 22 80+80 MHz non-high-throughput (non-HT) duplicate PPDU (TXVECTOR parameter CH_BANDWIDTH equal to CBW80+80).

bandwidth signaling transmitter address (TA): A TA that is used by a very high throughput (VHT) station (STA) to indicate the presence of additional signaling related to the bandwidth to be used in subsequent transmission in an enhanced distributed channel access (EDCA) transmission opportunity (TXOP). It is represented by the IEEE medium access control (MAC) individual address of the transmitting VHT STA but with the Individual/Group bit set to 1.

basic service set (BSS) basic very high throughput (VHT) modulation and coding scheme (MCS) and number of spatial streams (NSS) set (BSS basic VHT-MCS and NSS set): The set of MCS and NSS tuples that are supported by all VHT stations (STAs) that are members of a VHT BSS.

beamforming steering matrix: A matrix that describes the mapping of space-time streams to transmit antennas and for which the values have been determined using knowledge of the channel between transmitter and receiver with the goal of improving reception at the receiver.

dynamic bandwidth operation: A feature of a very high throughput (VHT) station (STA) in which the request-to-send/clear-to-send (RTS/CTS) exchange, using non-high-throughput (non-HT) duplicate physical layer (PHY) protocol data units (PPDUs), negotiates a potentially reduced channel width (compared to the channel width indicated by the RTS) for subsequent transmissions within the current transmission opportunity (TXOP).

end-of-frame (EOF) pad: The 0 to 3 octets used to pad an aggregate medium access control (MAC) protocol data unit (A-MPDU) to the last octet of the associated physical layer convergence procedure (PLCP) service data unit (PSDU) when the A-MPDU is carried in a very high throughput (VHT) physical layer (PHY) protocol data unit (PPDU).

high-throughput (HT) beamformee: An HT station (STA) that receives an HT physical layer (PHY) protocol data unit (PPDU) that was transmitted using a beamforming steering matrix and that supports an HT transmit beamforming feedback mechanism as described in either 9.29.2 or 9.29.3.

high-throughput (HT) beamformer: An HT station (STA) that transmits an HT physical layer (PHY) protocol data unit (PPDU) using a beamforming steering matrix.

medium access control (MAC) management protocol data unit (MMPDU): The unit of data exchanged between two peer MAC entities, using services of the physical layer (PHY), to implement the MAC management protocol. The MMPDU is transported in one or more management MPDUs. The MMPDU might include a Mesh Control field or Management MIC element, but does not include a MAC header, an frame check sequence (FCS), or any other security encapsulation overhead.

NOTE—The MMPDU occupies a position in the management plane similar to that of the MAC service data unit (MSDU) in the data plane. The MMPDU can be fragmented (under certain circumstances) and in that case is carried in multiple management MPDUs. This illustrates the similarity of the MMPDU to the MSDU.

multi-user (MU) beamformee: A non-access-point (non-AP) station (STA) that receives a physical layer (PHY) protocol data unit (PPDU) that was transmitted using a multi-user beamforming steering matrix and that supports the very high throughput (VHT) transmit beamforming feedback mechanism with a VHT null data packet (NDP) Announcement frame that includes more than one STA Info field as described in 9.31.5.

multi-user (MU) beamformer: An access point (AP) station (STA) that transmits a physical layer (PHY) protocol data unit (PPDU) using a multi-user beamforming steering matrix.

non-bandwidth signaling transmitter address (TA): An address in the TA field of an medium access control (MAC) protocol data unit (MPDU) in which the Individual/Group bit has the value 0.

non-high-throughput (non-HT): A modifier meaning neither high-throughput (HT) nor very high throughput (VHT).

non-primary channel: In a 40 MHz, 80 MHz, 160 MHz, or 80+80 MHz very high throughput (VHT) basic service set (BSS), any 20 MHz channel other than the primary 20 MHz channel.

physical layer (PHY) protocol data unit (PPDU): The unit of data exchanged between two peer PHY entities to provide the PHY data service. When the PHY is partitioned into physical layer convergence protocol (PLCP) and physical medium dependent (PMD) sublayers, the format of the PPDU is defined by the PLCP.

primary 20 MHz channel: In a 40 MHz, 80 MHz, 160 MHz, or 80+80 MHz very high throughput (VHT) basic service set (BSS), the 20 MHz channel that is used to transmit 20 MHz physical layer (PHY) protocol data units (PPDUs). In a VHT BSS, the primary 20 MHz channel is also the primary channel.

primary 40 MHz channel: In an 80 MHz, 160 MHz, or 80+80 MHz very high throughput (VHT) basic service set (BSS), the 40 MHz channel that is used to transmit 40 MHz physical layer (PHY) protocol data units (PPDUs).

primary 80 MHz channel: In a 160 MHz or 80+80 MHz very high throughput (VHT) basic service set (BSS), the 80 MHz channel that is used to transmit 80 MHz physical layer (PHY) protocol data units (PPDUs).

primary access category (AC): The access category (AC) associated with the enhanced distributed channel access function (EDCAF) that gains channel access.

secondary 20 MHz channel: In a 40 MHz very high throughput (VHT) basic service set (BSS), the 20 MHz channel adjacent to the primary 20 MHz channel that together form the 40 MHz channel of the 40 MHz VHT BSS. In an 80 MHz VHT BSS, the 20 MHz channel adjacent to the primary 20 MHz channel that together form the primary 40 MHz channel of the 80 MHz VHT BSS. In a 160 MHz or 80+80 MHz VHT BSS, the 20 MHz channel adjacent to the primary 20 MHz channel that together form the primary 40 MHz channel of the 160 MHz or 80+80 MHz VHT BSS. In a VHT BSS, the secondary 20 MHz channel is also the secondary channel.

secondary 40 MHz channel: In an 80 MHz very high throughput (VHT) basic service set (BSS), the 40 MHz channel adjacent to the primary 40 MHz channel that together form the 80 MHz channel of the 80 MHz VHT BSS. In a 160 or 80+80 MHz VHT BSS, the 40 MHz channel adjacent to the primary 40 MHz channel that together form the primary 80 MHz channel.

secondary 80 MHz channel: In a 160 MHz or 80+80 MHz very high throughput (VHT) basic service set (BSS), the 80 MHz channel not including the primary 20 MHz channel, that together with the primary 80 MHz channel forms the 160 MHz or 80+80 MHz channel of the 160 MHz or 80+80 MHz VHT BSS.

secondary access category (AC): An access category (AC) that is not associated with the enhanced distributed channel access function (EDCAF) that gains channel access.

NOTE—Traffic associated with a secondary AC can be included in a multi-user (MU) physical layer (PHY) protocol data unit (MU PPDU) that includes traffic associated with the primary AC. There could be multiple secondary ACs at a given time.

user: An individual or group of stations (STAs) identified by a single receive address (RA) in the context of single-user multiple input, multiple output (SU-MIMO) or multi-user multiple input, multiple output (MU-MIMO).

very high throughput (VHT) basic service set (BSS): A BSS in which a Beacon frame transmitted by a VHT station (STA) includes the VHT Operation element.

very high throughput (VHT) beamformee: A VHT station (STA) that receives a VHT physical layer (PHY) protocol data unit (PPDU) that was transmitted using a beamforming steering matrix and that supports the VHT transmit beamforming feedback mechanism as described in 9.31.5.

very high throughput (VHT) beamformer: A VHT station (STA) that transmits a VHT physical layer (PHY) protocol data unit (PPDU) using a beamforming steering matrix.

very high throughput modulation and coding scheme (VHT-MCS): A specification of the VHT physical layer (PHY) parameters that consists of modulation order (e.g., BPSK, QPSK, 16-QAM, 64-QAM, 256-QAM) and forward error correction (FEC) coding rate (e.g., 1/2, 2/3, 3/4, 5/6) and that is used in a VHT PHY protocol data unit (PPDU).

very high throughput (VHT) multi-user (MU) physical layer (PHY) protocol data unit (PPDU): A VHT PPDU with a format that is capable of carrying up to four PHY service data units (PSDUs) for up to four users and is transmitted using the downlink multi-user multiple input, multiple output (DL-MU-MIMO) technique.

very high throughput (VHT) physical layer (PHY) protocol data unit (PPDU): A PPDU transmitted with the TXVECTOR parameter FORMAT equal to VHT.

very high throughput (VHT) single medium access control (MAC) protocol data unit (VHT single MPDU): An MPDU that is the only MPDU in an aggregate MPDU (A-MPDU) carried in a VHT physical layer (PHY) protocol data unit (PPDU) and that is carried in an A-MPDU subframe with the EOF subfield of the MPDU delimiter field equal to 1.

very high throughput (VHT) single-user-only (SU-only) beamformee: A VHT beamformee that does not receive VHT multi-user (MU) physical layer (PHY) protocol data units (PPDUs).

very high throughput (VHT) single-user-only (SU-only) beamformer: A VHT beamformer that does not transmit VHT multi-user (MU) physical layer (PHY) protocol data units (PPDUs).

very high throughput (VHT) single-user (SU) physical layer (PHY) protocol data unit (PPDU): A VHT PPDU transmitted with the TXVECTOR parameters FORMAT equal to VHT and GROUP_ID equal to 0 or 63.

3.3 Abbreviations and acronyms

Change the following abbreviation in 3.3:

PPDU PLCP protocol data unit or PHY protocol data unit

Insert the following abbreviations into 3.3 in alphabetic order:

BW	bandwidth
DL-MU-MIMO	downlink multi-user multiple input, multiple output
EOF	end-of-frame
GCMP	Galois Counter Mode Protocol
GID	group identifier
MU	multi-user
MU-MIMO	multi-user multiple input, multiple output
NSS	number of spatial streams
STF	Short Training field

SU	single-user
SU-MIMO	single-user multiple input, multiple output
VHT	very high throughput

IECNORM.COM : Click to view the full PDF of ISO/IEC/IEEE 8802-11:2012/AMD4:2015

4. General description

4.3 Components of the IEEE 802.11 architecture

4.3.4 Distribution system (DS) concepts

4.3.4.3 Robust security network association (RSNA)

Change the first paragraph of 4.3.4.3 as follows:

An RSNA defines a number of security features in addition to wired equivalent privacy (WEP) and IEEE 802.11 authentication. These features include the following:

- Enhanced authentication mechanisms for STAs
- Key management algorithms
- Cryptographic key establishment
- Enhanced data cryptographic encapsulation mechanisms, such as Counter mode with Cipher-block chaining Message authentication code Protocol (CCMP), Galois Counter Mode Protocol (GCMP), and, optionally, Temporal Key Integrity Protocol (TKIP).
- Fast basic service set (BSS) transition (FT) mechanism
- Enhanced cryptographic encapsulation mechanisms for robust management frames

Insert the following subclause, 4.3.10a, after 4.3.10:

4.3.10a Very high throughput (VHT) STA

This subclause summarizes the normative requirements for an IEEE 802.11 VHT STA stated elsewhere in this standard.

The IEEE 802.11 VHT STA operates in frequency bands below 6 GHz excluding the 2.4 GHz band.

A VHT STA is an HT STA that, in addition to features supported as an HT STA, supports VHT features identified in Clause 8, Clause 9, Clause 10, Clause 13, Clause 18, and Clause 22.

The main PHY features in a VHT STA that are not present in an HT STA are the following:

- Mandatory support for 40 MHz and 80 MHz channel widths
- Mandatory support for VHT single-user (SU) PPDU
- Optional support for 160 MHz and 80+80 MHz channel widths
- Optional support for VHT sounding protocol to support beamforming
- Optional support for VHT multi-user (MU) PPDU
- Optional support for VHT-MCSs 8 and 9

The main MAC features in a VHT STA that are not present in an HT STA are the following:

- Mandatory support for the A-MPDU padding of a VHT PPDU
- Mandatory support for VHT single MPDU
- Mandatory support for responding to a bandwidth indication (provided by the RXVECTOR parameters CH_BANDWIDTH_IN_NON_HT and DYN_BANDWIDTH_IN_NON_HT) in a non-HT and non-HT duplicate RTS frame
- Optional support for MPDUs of up to 11 454 octets

- Optional support for A-MPDU pre-end-of-frame (pre-EOF) padding (see 9.12.2 (A-MPDU length limit rules)) of up to 1 048 575 octets
- Optional support for VHT link adaptation

Most VHT features, among other benefits, increase the maximum throughput achievable between two VHT STAs over that achievable using HT features alone. The VHT features are available to VHT STAs associated with a VHT AP in a BSS. A subset of the VHT features is available for use between two VHT STAs that are members of the same IBSS. Similarly, a subset of the VHT features is available for use between two VHT STAs that have established mesh peering. A subset of the VHT features is available for use between two VHT STAs that have established a TDLS link.

The support for VHT transmit beamforming sounding and VHT MU PPDU in a VHT AP and more than one VHT STA within a VHT BSS enables the optional use of downlink MU multiple input, multiple output (DL-MU-MIMO). With DL-MU-MIMO the AP can create up to four A-MPDUs, each carrying MPDUs destined for an associated MU-capable STA. The AP uses group identifiers (GIDs) to signal potential recipient STAs. The AP transmits the A-MPDUs simultaneously in separate space-time streams such that each recipient STA is able to demodulate the space-time streams carrying its A-MPDU. The simultaneous transmission of A-MPDUs in a single VHT MU PPDU provides a means to increase aggregate throughput over that achieved by sending the A-MPDUs in separate SU PPDU.

The use of certain HT features, such as RIFS, is not permitted for STAs operating as VHT STAs.

4.5 Overview of the services

4.5.4 Access control and data confidentiality services

4.5.4.1 General

Change the last paragraph of 4.5.4.1 as follows:

An RSNA uses the IEEE 802.1X authentication service along with enhanced data cryptographic encapsulation mechanisms, such as ~~TKIP~~, ~~and CCMP~~, ~~and GCMP~~ to provide access control. The IEEE 802.11 station management entity (SME) provides key management via an exchange of IEEE 802.1X EAPOL-Key frames. Data confidentiality and data integrity are provided by RSN key management together with the enhanced data cryptographic encapsulation mechanisms.

4.5.4.7 Replay detection

Change 4.5.4.7 as follows:

The replay detection mechanism defines a means by which a STA that receives a data or protected Robust Management frame from another STA can detect whether the received frame is an unauthorized retransmission. This replay protection mechanism is provided for data frames for STAs that use enhanced data cryptographic encapsulation mechanisms. The replay protection mechanism is also provided for robust management frames for STAs that use CCMP, GCMP, and Broadcast/Multicast Integrity Protocol (BIP).

4.5.4.9 Robust management frame protection

Change the second and third paragraphs of 4.5.4.9 as follows:

Management frame protection protocols in an infrastructure BSS or IBSS apply to robust management frames after RSNA PTK establishment for protection of individually addressed frames is completed and

after delivery of the IGTK to protect group addressed frames. Robust management frame protection is implemented by CCMP, GCMP, BIP, and the SA Query procedure.

Management frame protection protocols in an MBSS apply to individually addressed frames after establishment of the RSNA MTK, and to group addressed frames indicated as “Group Addressed Privacy” in Table 8-38. Robust management frame protection is implemented ~~by~~ with CCMP and GCMP.

4.9 Reference model

4.9.1 General

Insert the following paragraph after the first paragraph of 4.9.1:

The description of the VHT PHY in Clause 22 is provided as one layer and is not separated into PLCP and PMD sublayers.

IECNORM.COM : Click to view the full PDF of ISO/IEC/IEEE 8802-11:2012/AMD4:2015

5. MAC service definition

5.1 Overview of MAC services

5.1.2 Security services

Change the first, second, and fifth paragraphs of 5.1.2 as follows:

Security services in IEEE Std 802.11 are provided by the authentication service and the CCMP, GCMP, and BIP mechanisms. The scope of the security services provided is limited to station-to-station data and robust management frame transmissions. When CCMP or GCMP is used, the data confidentiality service is provided for data frames and individually addressed robust management frames. For the purposes of this standard, CCMP and GCMP are viewed as a logical services located within the MAC sublayer as shown in the reference model, Figure 4-14 (in 4.9). Actual implementations of CCMP and GCMP are transparent to the LLC and other layers above the MAC sublayer.

The security services provided by CCMP and GCMP in IEEE Std 802.11 are as follows:

- a) Data Confidentiality;
- b) Authentication; and
- c) Access control in conjunction with layer management.

BIP provides message integrity and access control for group addressed robust management frames.

During the authentication exchange, both parties exchange authentication information as described in Clause 11 and Clause 12.

The MAC sublayer security services provided by CCMP, GCMP, and BIP rely on information from nonlayer-2 management or system entities. Management entities communicate information to CCMP, GCMP, and BIP through a set of MAC sublayer management entity (MLME) interfaces and MIB attributes; in particular, the decision tree for CCMP, GCMP, and BIP defined in 11.8 is driven by MIB attributes.

5.2 MAC data service specification

5.2.2 MA-UNITDATA.request

5.2.2.2 Semantics of the service primitive

Change the fifth paragraph of 5.2.2.2 as follows:

The data parameter specifies the MSDU to be transmitted by the MAC sublayer entity. For IEEE Std 802.11, the length of the MSDU shall be less than or equal to the value shown in Table 8-13c.

6. Layer management

6.1 Overview of management model

Insert the following paragraph after the third paragraph of 6.1:

The description of the VHT PHY in Clause 22 is provided as one layer and is not separated into PLCP and PMD sublayers.

6.3 MLME SAP interface

6.3.3 Scan

6.3.3.3 MLME-SCAN.confirm

6.3.3.3.2 Semantics of the service primitive

Insert the following rows at the end of the untitled table describing BSSDescriptions in 6.3.3.3.2:

Name	Type	Valid range	Description	IBSS adoption
VHT Capabilities	As defined in frame format	As defined in 8.4.2.160	The values from the VHT Capabilities element. The parameter is present if dot11VHTOptionImplemented is true and a VHT Capabilities element was present in the Probe Response or Beacon frame from which the BSSDescription was determined. The parameter is not present otherwise.	Do not adopt
VHT Operation	As defined in frame format	As defined in 8.4.2.161	The values from the VHT Operation element. The parameter is present if dot11VHTOptionImplemented is true and a VHT Operation element was present in the Probe Response or Beacon frame from which the BSSDescription was determined. The parameter is not present otherwise.	Adopt

6.3.4 Synchronize

6.3.4.2 MLME-JOIN.request

6.3.4.2.2 Semantics of the service primitive

Change the primitive parameter list in 6.3.4.2.2 as follows:

The primitive parameters are as follows:

MLME-JOIN.request(

SelectedBSS,
JoinFailureTimeout,
ProbeDelay,
OperationalRateSet,
HTOperationalMCSSet,

OperationalVHTMCS_NSSSet,
VendorSpecificInfo
)

Insert the following row before the VendorSpecificInfo row in the parameter table in 6.3.4.2.2:

Name	Type	Valid range	Description
OperationalVHTMCS_NSSSet	Set of <VHT-MCS, NSS> tuples, constrained so that the MCS values are expressible using the encoding described for the Supported VHT-MCS and NSS Set field in 8.4.2.160.3	As defined in the Rx VHT-MCS Map and Rx Highest Supported Long GI Data Rate subfields in the Supported VHT-MCS and NSS Set field in 8.4.2.160.3	The set of VHT-MCS values for each number of spatial streams that the STA desires to use for communication within the BSS. This set is a superset of the <VHT-MCS, NSS> tuples in the BSS basic VHT-MCS and NSS set (see 10.39.7). The parameter is present if dot11VHTOptionImplemented is true and not present otherwise.

6.3.4.2.4 Effect of receipt

Insert the following paragraph at the end of 6.3.4.2.4:

If the MLME of a VHT STA receives an MLME-JOIN.request primitive with a SelectedBSS parameter containing a BSSDescription with a Basic VHT-MCS and NSS Set field in the VHT Operation element that contains any unsupported <VHT-MCS, NSS> tuple, the MLME response in the resulting MLME-JOIN.confirm primitive shall contain a ResultCode parameter that is not set to the value SUCCESS.

6.3.7 Associate

6.3.7.2 MLME-ASSOCIATE.request

6.3.7.2.2 Semantics of the service primitive

Change the primitive parameter list in 6.3.7.2.2 as follows:

The primitive parameters are as follows:

MLME-ASSOCIATE.request

- PeerSTAAddress,
- AssociateFailureTimeout,
- CapabilityInformation,
- ListenInterval,
- Supported Channels,
- RSN,
- QoSCapability,
- Content of FT Authentication elements,
- SupportedOperatingClasses,
- HT Capabilities,
- Extended Capabilities,
- 20/40 BSS Coexistence,
- QoSTrafficCapability,
- TIMBroadcastRequest,
- EmergencyServices,
- DMG Capabilities,
- Multi-band local,
- Multi-band peer,
- MMS,

VHT Capabilities,
VendorSpecificInfo
)

Insert the following row before the VendorSpecificInfo row in the parameter table in 6.3.7.2.2:

Name	Type	Valid range	Description
VHT Capabilities	As defined in VHT Capabilities element	As defined in 8.4.2.160	Specifies the parameters in the VHT Capabilities element that are supported by the STA. The parameter is present if dot11VHTOptionImplemented is true and not present otherwise.

6.3.7.3 MLME-ASSOCIATE.confirm

6.3.7.3.2 Semantics of the service primitive

Change the primitive parameter list in 6.3.7.3.2 as follows:

The primitive parameters are as follows:

MLME-ASSOCIATE.confirm(
 ResultCode,
 CapabilityInformation,
 AssociationID,
 SupportedRates,
 EDCAPParameterSet,
 RCPI.request,
 RSNL.request,
 RCPI.response,
 RSNL.response,
 RMEnabledCapabilities,
 Content of FT Authentication elements,
 SupportedOperatingClasses,
 HT Capabilities,
 Extended Capabilities,
 20/40 BSS Coexistence,
 TimeoutInterval,
 BSSMaxIdlePeriod,
 TIMBroadcastResponse,
 QoSMapSet,
 QMFPolicy,
 DMG Capabilities,
 Multi-band local,
 Multi-band peer,
 MMS,
VHT Capabilities,
 VendorSpecificInfo
)

Insert the following row before the VendorSpecificInfo row in the parameter table in 6.3.7.3.2:

Name	Type	Valid range	Description
VHT Capabilities	As defined in VHT Capabilities element	As defined in 8.4.2.160	Specifies the parameters in the VHT Capabilities element that are supported by the AP. The parameter is present if dot11VHTOptionImplemented is true and the VHT Capabilities element is present in the Association Response frame received from the AP. The parameter is not present otherwise.

6.3.7.4 MLME-ASSOCIATE.indication

6.3.7.4.2 Semantics of the service primitive

Change the primitive parameter list in 6.3.7.4.2 as follows:

The primitive parameters are as follows:

```

MLME-ASSOCIATE.indication(
    PeerSTAAddress,
    CapabilityInformation,
    ListenInterval,
    SSID,
    SupportedRates,
    RSN,
    QoSCapability,
    RCPI,
    RSNI,
    RMEnabledCapabilities,
    Content of FT Authentication elements,
    SupportedOperatingClasses,
    DSERegisteredLocation,
    HT Capabilities,
    Extended Capabilities,
    20/40 BSS Coexistence,
    QoSTrafficCapability,
    TIMBroadcastRequest,
    EmergencyServices,
    DMG Capabilities,
    Multi-band local,
    Multi-band peer,
    MMS,
    VHT Capabilities,
    VendorSpecificInfo
)

```

Insert the following row before the VendorSpecificInfo row in the parameter table in 6.3.7.4.2:

Name	Type	Valid range	Description
VHT Capabilities	As defined in VHT Capabilities element	As defined in 8.4.2.160	Specifies the parameters in the VHT Capabilities element that are supported by the STA. The parameter is present if dot11VHTOptionImplemented is true and the VHT Capabilities element is present in the Association Request frame received from the STA. The parameter is not present otherwise.

6.3.7.5 MLME-ASSOCIATE.response

6.3.7.5.2 Semantics of the service primitive

Change the primitive parameter list in 6.3.7.5.2 as follows:

The primitive parameters are as follows:

```
MLME-ASSOCIATE.response(
    PeerSTAAddress,
    ResultCode,
    CapabilityInformation,
    AssociationID,
    EDCAPParameterSet,
    RCPI,
    RSN,
    RMEnabledCapabilities,
    Content of FT Authentication elements,
    SupportedOperatingClasses,
    DSERegisteredLocation,
    HTCcapabilities,
    Extended Capabilities,
    20/40 BSS Coexistence,
    TimeoutInterval,
    BSSMaxIdlePeriod,
    TIMBroadcastResponse,
    QoSMapSet,
    QMFPolicy,
    DMG Capabilities,
    Multi-band local,
    Multi-band peer,
    MMS,
    VHT Capabilities,
    VendorSpecificInfo
)
```

Insert the following row before the VendorSpecificInfo row in the parameter table in 6.3.7.5.2:

Name	Type	Valid range	Description
VHT Capabilities	As defined in VHT Capabilities element	As defined in 8.4.2.160	Specifies the parameters in the VHT Capabilities element that are supported by the AP. The parameter is present if dot11VHTOptionImplemented is true and not present otherwise.

6.3.8 Reassociate

6.3.8.2 MLME-REASSOCIATE.request

6.3.8.2.2 Semantics of the service primitive

Change the primitive parameter list in 6.3.8.2.2 as follows:

The primitive parameters are as follows:

```

MLME-REASSOCIATE.request(
    NewPCPorAPAddress,
    ReassociateFailureTimeout,
    CapabilityInformation,
    ListenInterval,
    Supported Channels,
    RSN,
    QoSCapability,
    Content of FT Authentication elements,
    SupportedOperatingClasses,
    HT Capabilities,
    Extended Capabilities,
    20/40 BSS Coexistence,
    QoSTrafficCapability,
    TIMBroadcastRequest,
    FMSRequest,
    DMSRequest,
    EmergencyServices,
    DMG Capabilities,
    Multi-band local,
    Multi-band peer,
    MMS,
    VHT Capabilities,
    VendorSpecificInfo
)

```

Insert the following row before the VendorSpecificInfo row in the parameter table in 6.3.8.2.2:

Name	Type	Valid range	Description
VHT Capabilities	As defined in VHT Capabilities element	As defined in 8.4.2.160	Specifies the parameters in the VHT Capabilities element that are supported by the STA. The parameter is present if dot11VHTOptionImplemented is true and not present otherwise.

6.3.8.3 MLME-REASSOCIATE.confirm

6.3.8.3.2 Semantics of the service primitive

Change the primitive parameter list in 6.3.8.3.2 as follows:

The primitive parameters are as follows:

```

MLME-REASSOCIATE.confirm(
    ResultCode,
    CapabilityInformation,

```

AssociationID,
 SupportedRates,
 EDCAPparameterSet,
 RCPI.request,
 RSNL.request,
 RCPI.response,
 RSNL.response,
 RMEnabledCapabilities,
 Content of FT Authentication elements,
 SupportedOperatingClasses,
 HT Capabilities,
 Extended Capabilities,
 20/40 BSS Coexistence,
 TimeoutInterval,
 BSSMaxIdlePeriod,
 TIMBroadcastResponse,
 FMSResponse,
 DMSResponse,
 QoSMapSet,
 QMFPolicy,
 DMG Capabilities,
 Multi-band local,
 Multi-band peer,
 MMS,
VHT Capabilities,
 VendorSpecificInfo
)

Insert the following row before the VendorSpecificInfo row in the parameter table in 6.3.8.3.2:

Name	Type	Valid range	Description
VHT Capabilities	As defined in VHT Capabilities element	As defined in 8.4.2.160	Specifies the parameters in the VHT Capabilities element that are supported by the AP. The parameter is present if dot11VHTOptionImplemented is true and the VHT Capabilities element is present in the Reassociation Response frame received from the AP. The parameter is not present otherwise.

6.3.8.4 MLME-REASSOCIATE.indication

6.3.8.4.2 Semantics of the service primitive

Change the primitive parameter list in 6.3.8.4.2 as follows:

The primitive parameters are as follows:

MLME-REASSOCIATE.indication(
 PeerSTAAddress,
 CurrentAPAddress,
 CapabilityInformation,
 ListenInterval,
 SSID,
 SupportedRates,
 RSN,

QoS Capability,
 RCPI,
 RSNI,
 RMCapabilities,
 Content of FT Authentication elements,
 SupportedOperatingClasses,
 DSERegisteredLocation,
 HT Capabilities,
 Extended Capabilities,
 20/40 BSS Coexistence,
 QoS Traffic Capability,
 TIM Broadcast Request,
 FMS Request,
 DMS Request,
 Emergency Services,
 DMG Capabilities,
 Multi-band local,
 Multi-band peer,
 MMS,
VHT Capabilities,
 VendorSpecificInfo
)

Insert the following row before the VendorSpecificInfo row in the parameter table in 6.3.8.4.2:

Name	Type	Valid range	Description
VHT Capabilities	As defined in VHT Capabilities element	As defined in 8.4.2.160	Specifies the parameters in the VHT Capabilities element that are supported by the STA. The parameter is present if dot11VHTOptionImplemented is true and the VHT Capabilities element is present in the Reassociation Request frame received from the STA. The parameter is not present otherwise.

6.3.8.5 MLME-REASSOCIATE.response

6.3.8.5.2 Semantics of the service primitive

Change the primitive parameter list in 6.3.8.5.2 as follows:

The primitive parameters are as follows:

MLME-REASSOCIATE.response(
 PeerSTAAddress,
 ResultCode,
 CapabilityInformation,
 AssociationID,
 EDCAPParameterSet,
 RCPI,
 RSNI,
 RMCapabilities,
 Content of FT Authentication elements,
 SupportedOperatingClasses,
 DSERegisteredLocation,
 HT Capabilities,
)

Extended Capabilities,
 20/40 BSS Coexistence,
 TimeoutInterval,
 BSSMaxIdlePeriod,
 TIMBroadcastResponse,
 FMSResponse,
 DMSResponse,
 QoSMapSet,
 QMFPolicy,
 DMG Capabilities,
 Multi-band local,
 Multi-band peer,
 MMS,
VHT Capabilities,
 VendorSpecificInfo
)

Insert the following row before the VendorSpecificInfo row in the parameter table in 6.3.8.5.2:

Name	Type	Valid range	Description
VHT Capabilities	As defined in VHT Capabilities element	As defined in 8.4.2.160	Specifies the parameters in the VHT Capabilities element that are supported by the AP. The parameter is present if dot11VHTOptionImplemented is true and not present otherwise.

6.3.11 Start

6.3.11.2 MLME-START.request

6.3.11.2.2 Semantics of the service primitive

Change the primitive parameter list in 6.3.11.2.2 as follows:

The primitive parameters are as follows:

MLME-START.request(
 SSID,
 SSIDEncoding,
 BSSType,
 BeaconPeriod,
 DTIMPeriod,
 CF parameter set,
 PHY parameter set,
 IBSS parameter set,
 ProbeDelay,
 CapabilityInformation,
 BSSBasicRateSet,
 OperationalRateSet,
 Country,
 IBSS DFS Recovery Interval,
 EDCAPparameterSet,
 DSERegisteredLocation,
 HT Capabilities,
 HT Operation,

BSSMembershipSelectorSet,
 BSSBasicMCSSet,
 HTOperationalMCSSet,
 Extended Capabilities,
 20/40 BSS Coexistence,
 Overlapping BSS Scan Parameters,
 MultipleBSSID,
 InterworkingInfo,
 AdvertisementProtocolInfo,
 RoamingConsortiumInfo,
 Mesh ID,
 Mesh Configuration,
 QMFPolicy,
 DMG Capabilities,
 Multi-band,
 MMS,
 DMG Operation,
 Clustering Control,
 CBAP Only,
 PCP Association Ready,
VHT Capabilities,
VHT Operation,
 VendorSpecificInfo
)

Insert the following rows before the VendorSpecificInfo row in the parameter table in 6.3.11.2.2:

Name	Type	Valid range	Description
VHT Capabilities	As defined in VHT Capabilities element	As defined in 8.4.2.160	Specifies the parameters in the VHT Capabilities element that are supported by the STA. The parameter is present if dot11VHTOptionImplemented is true and not present otherwise.
VHT Operation	As defined in VHT Operation element	As defined in 8.4.2.161	Provides additional information for operating the VHT BSS. The parameter is present if dot11VHTOptionImplemented is true and not present otherwise.

6.3.11.2.4 Effect of receipt

Insert the following paragraph before the last paragraph of 6.3.11.2.4:

If the MLME of a VHT STA receives an MLME-START.request primitive with a Basic VHT-MCS and NSS Set field in the VHT Operation parameter containing any unsupported <VHT-MCS, NSS> tuple, the MLME response in the resulting MLME-START.confirm primitive shall contain a ResultCode parameter that is not set to the value SUCCESS.

6.3.19 SetKeys**6.3.19.1 MLME-SETKEYS.request****6.3.19.1.2 Semantics of the service primitive**

Change the following row in the untitled table describing SetKeyDescriptors in 6.3.19.1.2 as follows:

Name	Type	Valid range	Description
Key ID	Integer	0–3 shall be used with WEP, TKIP, and CCMP, and GCMP; 4–5 with BIP; and 6–4095 are reserved.	Key identifier

6.5 PLME SAP interface**6.5.4 PLME-CHARACTERISTICS.confirm****6.5.4.2 Semantics of the service primitive**

Change 6.5.4.2 as follows (note that the entire untitled parameter table is not shown):

The primitive provides the following parameters:

```

PLME-CHARACTERISTICS.confirm(
    aSlotTime,
    aSIFSTime,
    aSignalExtension,
    aCCATime,
    aCCAMidTime.
    aPHY-RX-START-Delay,
    aRxTxTurnaroundTime,
    aTxPLCPDelay,
    aRxPLCPDelay,
    aRxTxSwitchTime,
    aTxRampOnTime,
    aTxRampOffTime,
    aTxRFDelay,
    aRxRFDelay,
    aAirPropagationTime,
    aMACProcessingDelay,
    aPreambleLength,
    aRIFSTime,
    aSymbolLength,
    aSTFOneLength,
    aSTFTwoLength,
    aLTFOneLength,
    aLTFTwoLength,
    aPLCPHeaderLength,
    aPLCPSigTwoLength,
    aPLCPServiceLength,
    aPLCPConvolutionalTailLength,

```

aMPDUDurationFactor,
aMPDUMaxLength,
aPSDUMaxLength,
aPPDUMaxTime,
aIUSTime,
aDTT2UTTTTime,
aCWmin,
aCWmax,
aMaxCSIMatricesReportDelay,
aMaxTODError,
aMaxTOAError,
aTxPmdTxStartRFDelay,
aTxPmdTxStartRMS,
aTxPHYDelay,
aRxPHYDelay,
aTxPHYTxStartRFDelay,
aTxPHYTxStartRMS
)

The values assigned to the parameters ~~is~~ are as specified in the PLME SAP interface specification contained within each PHY subclass of this standard. ~~The parameter aMPDUDurationFactor is not used by all PHYs defined within this standard. The parameters aSignalExtension, aRIFSTime, aSymbolLength, aSTFOneLength, aSTFTwoLength, aLTFOneLength, aLFTTwoLength, aPLCPSigTwoLength, aPLCPServiceLength, aPLCPConvolutionalTailLength, aMPDUDurationFactor, aMPDUMaxLength, aPSDUMaxLength, aPPDUMaxTime, aIUSTime, aDTT2UTTTTime, and aMaxCSIMatricesReportDelay are not used by all PHYs defined within this standard. Not all parameters are used by all PHYs defined within this standard.~~

Name	Type	Description
...		
aCCATime	integer	For Clause 14 through Clause 19 PHYs and Clause 21 PHYs, t <u>The maximum time (in microseconds) the CCA mechanism has available to assess the medium within every time slot to determine whether the medium is busy or idle. For Clause 20 and Clause 22 PHYs, the maximum time (in microseconds) that the CCA mechanism has available to detect the start of a valid IEEE 802.11 transmission within the primary channel and to assess the energy on the medium within the primary, secondary, secondary40 (Clause 22 PHY only), and secondary80 (Clause 22 PHY only) channels that fall inside the operating channel, in order to determine the values of the STATE and channel-list parameters of the PHY-CCA.indication primitive.</u>
aCCAMidTime	integer	For Clause 22 PHYs, the maximum time (in microseconds) the CCA mechanism has available to assess the medium to determine whether an IEEE 802.11 transmission is present on a non-primary channel.
...		
aRxTxTurnaroundTime	integer	The maximum time (in microseconds) that the PHY requires to change from receiving to transmitting the start of the first symbol. When transmitting a non-VHT PPDU, the <u>The following equation is used to derive aRxTxTurnaroundTime:</u> $aTxPLCPDelay + aRxTxSwitchTime + aTxRampOnTime + aTxRFDelay.$ When transmitting a VHT PPDU, the following equation is used to derive aRxTxTurnaroundTime: $aTxPHYDelay + aRxTxSwitchTime + aTxRampOnTime.$
aTxPLCPDelay	integer	The <u>When transmitting a non-VHT PPDU, the</u> nominal time (in microseconds) that the PLCP uses to deliver a symbol from the MAC interface to the transmit data path of the physical medium dependent (PMD).
aRxPLCPDelay	integer	The <u>When receiving a non-VHT PPDU, the</u> nominal time (in microseconds) that the PLCP uses to deliver the last bit of a received frame from the PMD receive path to the MAC.

Name	Type	Description
aRxTxSwitchTime	integer	The When transmitting a non-VHT PPDU, the nominal time (in microseconds) that the PMD takes to switch from Receive to Transmit. <u>When transmitting a VHT PPDU, the nominal time (in microseconds) that the PHY takes to switch from Receive to Transmit.</u>
aTxRampOnTime	integer	The When transmitting a non-VHT PPDU, the maximum time (in microseconds) that the PMD takes to turn the Transmitter on. <u>When transmitting a VHT PPDU, the maximum time (in microseconds) that the PHY takes to turn the Transmitter on.</u>
aTxRampOffTime	integer	The When transmitting a non-VHT PPDU, the nominal time (in microseconds) that the PMD takes to turn the Transmit Power Amplifier off. <u>When transmitting a VHT PPDU, the nominal time (in microseconds) that the PHY takes to turn the Transmit Power Amplifier off.</u>
aTxRFDelay	integer	The When transmitting a non-VHT PPDU, the nominal time (in microseconds) between the issuance of a PMD_DATA.request primitive to the PMD and the start of the corresponding symbol at the air interface. The start of a symbol is defined to be 1/2 symbol period prior to the center of the symbol for FH, or 1/2 chip period prior to the center of the first chip of the symbol for DS, or 1/2 slot time prior to the center of the corresponding slot for infrared (IR).
aRxRFDelay	integer	The When receiving a non-VHT PPDU, the nominal time (in microseconds) between the end of a symbol at the air interface to the issuance of a PMD_DATA.indication primitive to the PLCP. The end of a symbol is defined to be 1/2 symbol period after the center of the symbol for FH, or 1/2 chip period after the center of the last chip of the symbol for DS, or 1/2 slot time after the center of the corresponding slot for IR.
...		
aTxPmdTxStartRFDelay	integer	The When transmitting a non-VHT PPDU, the delay (in units of 0.5 ns) between PMD_TXSTART.request being issued and the first frame energy sent by the transmitting port, for the current channel.
aTxPmdTxStartRMS	integer	The When transmitting a non-VHT PPDU, the RMS time of departure error (in units of 0.5 ns), where the time of departure error equals the difference between TIME_OF_DEPARTURE and the time of departure measured by a reference entity using a clock synchronized to the start time and mean frequency of the local PHY entity's clock.
aTxPHYDelay	integer	When transmitting a VHT PPDU, the nominal time (in microseconds) that the PHY uses to deliver a symbol from the MAC interface to the air interface.
aRxPHYDelay	integer	When receiving a VHT PPDU, the nominal time (in microseconds) that the PHY uses to deliver the last bit of a received frame from the end of the last OFDM symbol at the air interface to the MAC.
aTxPHYTxStartRFDelay	integer	When transmitting a VHT PPDU, the delay (in units of 0.5 ns) between PMD_TXSTART.request being issued and the first frame energy sent by the transmitting port, for the current channel.
aTxPHYTxStartRMS	integer	When transmitting a VHT PPDU, the RMS time of departure error (in units of 0.5 ns), where the time of departure error equals the difference between TIME_OF_DEPARTURE and the time of departure measured by a reference entity using a clock synchronized to the start time and mean frequency of the local PHY entity's clock.

6.5.8 PLME-TXTIME.confirm

Change 6.5.8.1 and 6.5.8.2 as follows:

6.5.8.1 Function

This primitive indicates the time required to transmit the PPDU described in the corresponding PLME-TXTIME.request.

When the TXVECTOR parameter FORMAT in the corresponding PLME-TXTIME.request primitive is VHT, the primitive also provides the number of octets, per user, required to fill the PPDU.

6.5.8.2 Semantics of the service primitive

This primitive provides the following parameters:

```
PLME-TXTIME.confirm(  
    TXTIME_  
    PSDU_LENGTH[]  
)
```

The TXTIME represents the time, in microseconds, required to transmit the PPDU described in the corresponding PLME-TXTIME.request primitive. If the calculated time includes a fractional microsecond, a non-DMG STA rounds the TXTIME value up to the next higher integer. A DMG STA does not round the TXTIME value up or down (see 21.12.3).

The PSDU_LENGTH[] parameter is an array of size TXVECTOR parameter NUM_USERS. Each value in the array indicates the number of octets required to fill the PPDU for the user represented by that array index. The parameter is present only when the TXVECTOR FORMAT parameter is VHT.

7. PHY service specification

7.1 Scope

Insert the following paragraph at the end of 7.1:

The description of the VHT PHY in Clause 22 is provided as one layer and is not separated into PLCP and PMD sublayers.

7.2 PHY functions

Insert the following paragraph at the end of 7.2:

The description of the VHT PHY in Clause 22 is provided as one layer and is not separated into PLCP and PMD sublayers.

7.3 Detailed PHY service specifications

7.3.2 Overview of the service

Insert the following paragraph at the end of 7.3.2:

The description of the VHT PHY in Clause 22 is provided as one layer and is not separated into PLCP and PMD sublayers.

7.3.4 Basic service and options

7.3.4.5 Vector descriptions

Insert the following rows at the end of Table 7-4:

Table 7-4—Vector descriptions

Parameter	Associate vector	Value
GROUP_ID_MANAGEMENT	PHYCONFIG_VECTOR	Specifies membership status and STA position for each of the group IDs as described in 8.5.23.3
PARTIAL_AID_LIST_GID00	PHYCONFIG_VECTOR	Includes the list of partial AIDs, of which the STA is an intended recipient, associated with group ID 0. The settings of the PARTIAL_AID are specified in 9.17a).
PARTIAL_AID_LIST_GID63	PHYCONFIG_VECTOR	Includes the list of partial AIDs, of which the STA is an intended recipient, associated with group ID 63. The settings of the PARTIAL_AID are specified in 9.17a).

Table 7-4—Vector descriptions (continued)

Parameter	Associate vector	Value
LISTEN_TO_GID00	PHYCONFIG_VECTOR	When true, indicates to the PHY not to filter out PPDU with GROUP_ID field equal to the value 0.
LISTEN_TO_GID63	PHYCONFIG_VECTOR	When true, indicates to the PHY not to filter out PPDU with GROUP_ID field equal to the value 63.

7.3.5 PHY-SAP detailed service specification

7.3.5.2 PHY-DATA.request

7.3.5.2.2 Semantics of the service primitive

Change 7.3.5.2.2 as follows:

The primitive provides the following parameters:

```
PHY-DATA.request(
    DATA_
    USER_INDEX
)
```

The DATA parameter is an octet of value X'00' to X'FF'.

The USER_INDEX parameter (typically identified as u for a VHT STA; see NOTE 1 at the end of Table 22-1) is present for a VHT MU PPDU and indicates the index of the user in the TXVECTOR to which the accompanying DATA octet applies; otherwise, this parameter is not present.

7.3.5.3 PHY-DATA.indication

7.3.5.3.3 When generated

Change 7.3.5.3.3 as follows:

The PHY-DATA.indication primitive is generated by a receiving PHY entity to transfer the received octet of data to the local MAC entity. ~~The~~ For a non-VHT PPDU, the time between receipt of the last bit of the provided octet from the WM and the receipt of this primitive by the MAC entity is the sum of aRxRFDelay + aRxPLCPDelay. For a VHT PPDU, the time between receipt of the last bit of the last provided octet from the WM and the receipt of this primitive by the MAC entity is aRxPHYDelay.

7.3.5.6 PHY-TXSTART.confirm

7.3.5.6.3 When generated

Change 7.3.5.6.3 as follows:

This primitive is issued by the PHY to the MAC entity once all of the following conditions are met:

- The PHY has received a PHY-TXSTART.request primitive from the MAC entity.

- ~~The~~ When transmitting a non-VHT PPDU, the PLCP has issued PMD.TXSTATUS.request primitive if dot11MgmtOptionTODActivated is true and the TXVECTOR parameter TIME_OF_DEPARTURE_REQUESTED in the PHY-TXSTART.request(TXVECTOR) primitive is true.
- The PHY is ready to begin accepting outgoing data octets from the MAC.

7.3.5.11 PHY-CCA.indication

7.3.5.11.2 Semantics of the service primitive

Change the fourth paragraph, and insert the new table (Table 7-5), one new paragraph, and two new figures (Figure 7-1 and Figure 7-2) at the end of 7.3.5.11.2 as follows:

When STATE is IDLE or when, for the type of PHY in operation, CCA is determined by a single channel, the channel-list parameter is absent. Otherwise, it carries a set indicating which channels are busy, represented by the values {primary}, {primary, secondary}, and {secondary}. The channel-list parameter in a PHY-CCA.indication primitive generated by a VHT STA contains at most a single element. Table 7-5 defines the members of this set.

Table 7-5—The channel-list parameter elements

<u>channel-list element</u>	<u>Meaning</u>
<u>primary</u>	<u>For an HT STA that is not a VHT STA, indicates that the primary 20 MHz channel is busy.</u> <u>For a VHT STA, indicates that the primary 20 MHz channel is busy according to the rules specified in 22.3.19.5.3.</u>
<u>secondary</u>	<u>For an HT STA that is not a VHT STA, indicates that the secondary channel is busy.</u> <u>For a VHT STA, indicates that the secondary 20 MHz channel is busy according to the rules specified in 22.3.19.5.4.</u>
<u>secondary40</u>	<u>Indicates that the secondary 40 MHz channel is busy according to the rules specified in 22.3.19.5.4.</u>
<u>secondary80</u>	<u>Indicates that the secondary 80 MHz channel is busy according to the rules specified in 22.3.19.5.4.</u>

The relationship of the channel-list parameter elements to the 40 MHz, 80 MHz, and 160 MHz BSS operating channel is illustrated by example in Figure 7-1. The relationship of the channel-list parameter elements to the 80+80 MHz BSS operating channel is illustrated by example in Figure 7-2.

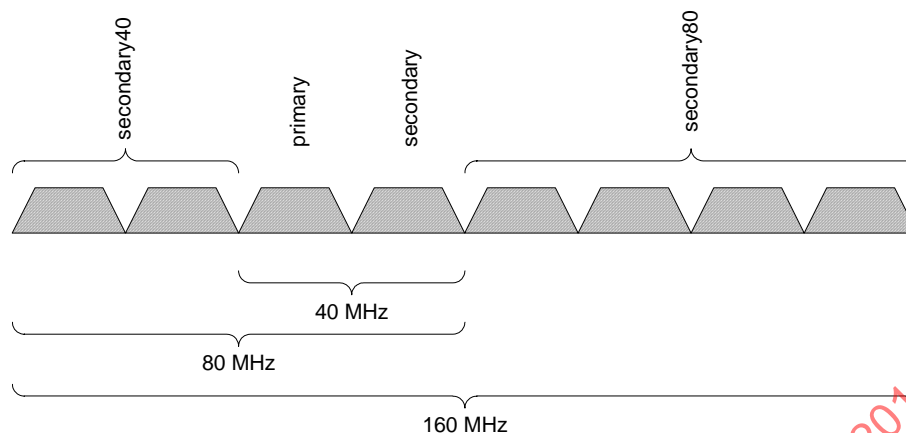

Figure 7-1—The channel-list parameter element for 40 MHz, 80 MHz, and 160 MHz channel width

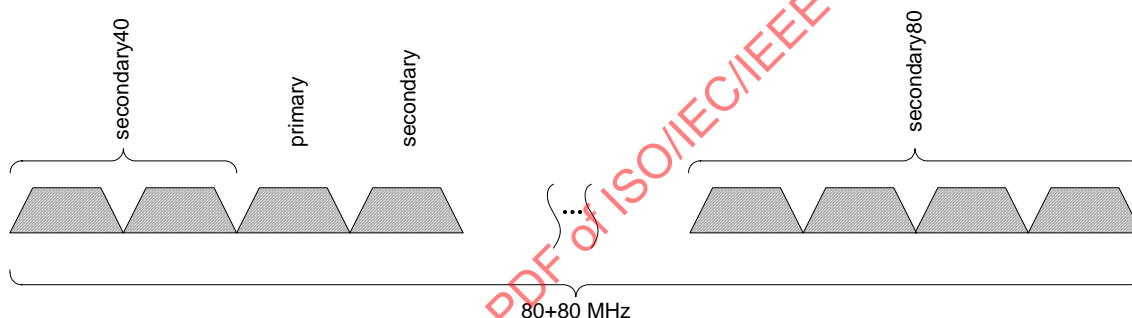

Figure 7-2—The channel-list parameter element for 80+80 MHz channel width

7.3.5.11.3 When generated

Change 7.3.5.11.3 as follows:

For Clause 14 through Clause 21 PHYs, ~~This primitive is generated within aCCATime of the occurrence of a change in the status of the channel(s) from channel idle to channel busy or from channel busy to channel idle or when the elements of the channel-list parameter change; otherwise, this primitive is generated when the status of the channel(s) changes from channel idle to channel busy or from channel busy to channel idle or when the elements of the channel-list parameter change.~~ This includes the period of time when the PHY is receiving data. Refer to specific PHY clauses for details about CCA behavior for a given PHY.

NOTE—For the VHT PHY, the timing information is omitted here and is defined in 22.3.19.5.

If the STA is an HT STA but not a VHT STA and the operating channel width is 20 MHz, the PHY maintains the channel busy indication until the period indicated by the LENGTH field has expired, where the LENGTH field is

- In a valid SIG field if the format of the PPDU is NON_HT
- In a valid HT-SIG field if the format of the PPDU is HT_MF or HT_GF

If the STA is an HT STA but not a VHT STA and the operating channel width is 40 MHz, the PHY maintains the channel busy indication until the period indicated by the LENGTH field has expired, where the LENGTH field is

- In a valid SIG field if the format of the PPDU is NON_HT and the PPDU is received in the primary channel
- In a valid HT-SIG field if the format of the PPDU is HT_MF or HT_GF provided that the PPDU is either a 20 MHz PPDU received in the primary channel or a 40 MHz PPDU

7.3.5.13 PHY-RXEND.indication

7.3.5.13.2 Semantics of the service primitive

Insert the following list item and note at the end of the list of error conditions after the second paragraph of 7.3.5.13.2:

- *Filtered.* This value is used to indicate that during the reception of the PPDU, the PPDU was filtered out due to a condition set in the PHYCONFIG_VECTOR.

NOTE—The filtered condition might occur in a VHT STA due to GROUP_ID or PARTIAL_AID filtering in the PHY layer.

8.2.4.1.10 Order field

Change the second bullet in the dashed list of the first paragraph of 8.2.4.1.10 as follows:

- It is set to 1 in a QoS data or management frame transmitted with a value of HT_GF ~~or HT_MF~~ or VHT for the FORMAT parameter of the TXVECTOR to indicate that the frame contains an HT Control field.

8.2.4.2 Duration/ID field

Change the fourth paragraph of 8.2.4.2 as follows:

The Duration/ID fields in the MAC headers of MPDUs in an A-MPDU all carry the same value. The Duration/ID fields in the MAC headers of MPDUs in A-MPDUs carried in the same VHT MU PPDU all carry the same value.

8.2.4.3 Address fields

8.2.4.3.8 TA field

Change 8.2.4.3.8 as follows:

The TA field contains an IEEE MAC ~~individual~~ address that identifies the STA that has transmitted, onto the WM, the MPDU contained in the frame body field. If the Individual/Group bit is 0, then the TA field is the individual address of the STA; otherwise, the TA field is a bandwidth signaling TA, indicating that the frame carries additional information in the scrambling sequence (see 8.3.1.2, 9.7.6.6, and 9.7.10). ~~The Individual/Group bit is always transmitted as a 0 in the transmitter address.~~

8.2.4.5 QoS Control field

8.2.4.5.4 Ack Policy subfield

Change the first row in Table 8-6 as follows:

Table 8-6—Ack Policy subfield in QoS Control field of QoS data frames

Bits in QoS Control field		Meaning
Bit 5	Bit 6	
0	0	<p>Normal Ack or Implicit Block Ack Request.</p> <p>In a frame that is a non-A-MPDU frame or VHT single MPDU: The addressed recipient returns an ACK or QoS +CF-Ack frame after a short interframe space (SIFS) period, according to the procedures defined in 9.3.2.8 and 9.19.3.5. For a non-DMG STA, this is the only permissible value for the Ack Policy subfield for individually addressed QoS Null (no data) frames.</p> <p>In a frame that is part of an A-MPDU Otherwise: The addressed recipient returns a BlockAck MPDU, either individually or as part of an A-MPDU starting a SIFS after the PPDU carrying the frame, according to the procedures defined in 9.3.2.9, 9.21.7.5, 9.21.8.3, 9.25.3, 9.25.4, and 9.29.3.</p>

Change 8.2.4.6, including inserting new text, one new figure (Figure 8-5a), and two new subclause titles and moving two existing tables (without renumbering at this time), as follows:

8.2.4.6 HT Control field

8.2.4.6.1 General

The HT Control field is always present in a Control Wrapper frame and is present in QoS Data and management frames as determined by the Order bit of the Frame Control field as defined in 8.2.4.1.10.

NOTE—The only Control frame subtype for which HT Control field is present is the Control Wrapper frame. A control frame that is described as +HTC (e.g., RTS+HTC, CTS+HTC, BlockAck+HTC or BlockAckReq+HTC) implies the use of the Control Wrapper frame to carry that control frame.

The format of the 4-octet HT Control field is shown in Figure 8-5.

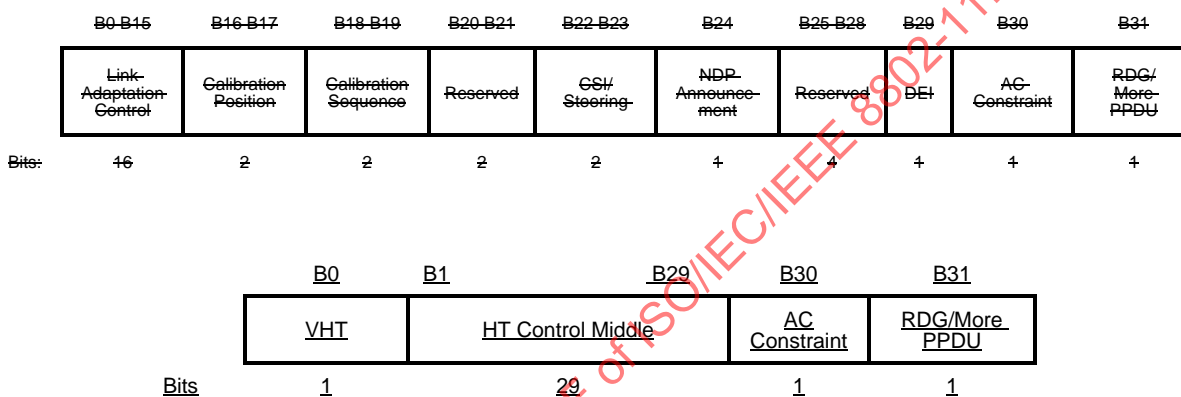

Figure 8-5—HT Control field

The HT Control field has two forms, the HT variant and the VHT variant. The two forms differ in the format of the HT Control Middle subfield, described in 8.2.4.6.2 for the HT variant and in 8.2.4.6.3 for the VHT variant and in the value of the VHT subfield.

The VHT subfield of the HT Control field indicates whether the HT Control Middle subfield is the VHT Variant or the HT Variant. The VHT subfield is set to 1 to indicate that the HT Control Middle subfield is the VHT Variant and is set to 0 to indicate that the HT Control Middle subfield is the HT Variant.

The AC Constraint subfield of the HT Control field indicates whether the mapped AC of an RD data frame is constrained to a single AC, as defined in Table 8-12.

Table 8-12 remains unchanged.

The RDG/More PPDU subfield of the HT Control field is interpreted differently depending on whether it is transmitted by an RD initiator or an RD responder, as defined in Table 8-13.

Table 8-13 remains unchanged.

8.2.4.6.2 HT variant

The format of the HT Control Middle subfield of the HT variant HT Control field is shown in Figure 8-5a.

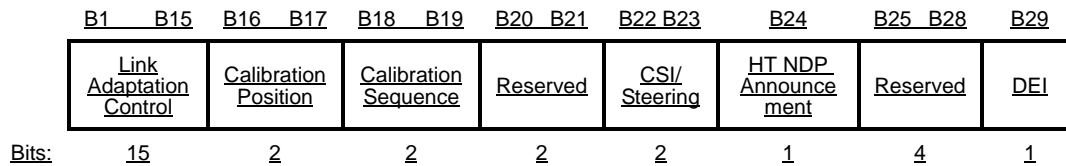

Figure 8-5a—HT Control Middle subfield of the HT variant HT Control field

The format of the Link Adaptation Control subfield of the HT variant HT Control field is defined in Figure 8-6.

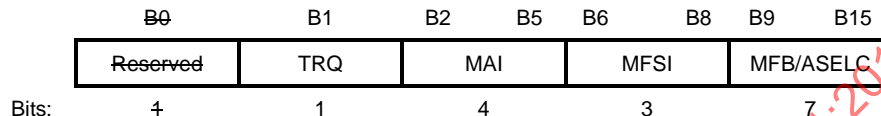

Figure 8-6—Link Adaptation Control subfield

The text from “The subfields of the Link Adaptation Control subfield ... is shown in Table 8-9.” (including Table 8-7, Table 8-8, Figure 8-7, and Figure 8-8) remains unchanged.

Change the note in Table 8-9 as follows (note that the body of the table is omitted here):

Table 8-9—ASEL Command and ASEL Data subfields

ASEL Command	Interpretation of ASEL Command	ASEL Data
...		
NOTE—If the <u>HT variant</u> HT Control field is carried in a sounding PPDU, then the value of the ASEL Data field contains the remaining number of sounding frames following the current one. If null data packet (NDP) sounding frame is used, then the value in the ASEL Data field contains the number of NDPs following a non-NDP+HTC. The <u>HT NDP Announcement</u> subfield in the HT Control field is set to 1 to indicate NDP sounding.		

The Calibration Position and Calibration Sequence subfields of the HT variant HT Control field are defined in Table 8-10.

The Calibration Sequence subfield identifies an instance of the calibration procedure. The subfield is included in each frame within a calibration procedure, and its value is unchanged for frames within the same calibration procedure.

Table 8-10 remains unchanged.

The CSI/Steering subfield of the HT variant HT Control field indicates the type of feedback, as shown in Table 8-11.

Table 8-11 remains unchanged.

The HT NDP Announcement subfield of the HT variant HT Control field indicates that an NDP will be transmitted after the frame (according to the rules described in 9.31). It is set to 1 to indicate that an NDP will follow; otherwise, it is set to 0.

The DEI subfield is 1 bit in length and is set by the transmitting STA to indicate the suitability of the corresponding MSDU or A-MSDU to be discarded if there are insufficient resources at the receiving STA. If there are insufficient resources, a STA that receives an MPDU whose DEI subfield is equal to 1 carrying all or part of an MSDU or A-MSDU should discard the MSDU or any MSDUs contained within the A-MSDU in preference to MSDUs carried in MPDUs whose DEI subfield is equal to 0. See 10.26.2. In an MMPDU, the DEI subfield is reserved. The mechanisms for determining whether the resources are insufficient or when to discard MSDUs or A-MSDUs are beyond the scope of this standard.

The AC Constraint subfield of the HT Control field indicates whether the mapped AC of an RD data frame is constrained to a single AC, as defined in Table 8-12.

The RDG/More PPDU subfield of the HT Control field is interpreted differently depending on whether it is transmitted by an RD initiator or an RD responder, as defined in Table 8-13.

Insert the following subclause, 8.2.4.6.3 (including Figure 8-8a, Figure 8-8b, Figure 8-8c, Table 8-13a, and Table 8-13b), after 8.2.4.6.2:

8.2.4.6.3 VHT variant

The format of the HT Control Middle subfield of the VHT variant HT Control field is shown in Figure 8-8a.

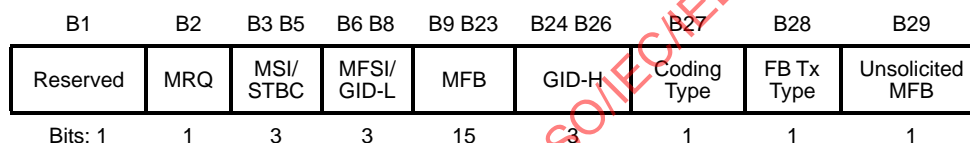

Figure 8-8a—HT Control Middle subfield of the VHT variant HT Control field

The subfields of VHT variant HT Control field are defined in Table 8-13a.

Table 8-13a—VHT variant HT Control field subfields

Subfield	Meaning	Definition
MRQ	VHT-MCS feedback request	Set to 1 to request VHT-MCS feedback (solicited MFB); otherwise, set to 0.
MSI/STBC	MRQ sequence identifier/STBC indication	<p>If the Unsolicited MFB subfield is 0 and the MRQ subfield is 1, the MSI/STBC subfield contains a sequence number in the range 0 to 6 that identifies the specific MCS feedback request.</p> <p>If the Unsolicited MFB subfield is 0 and the MRQ subfield is 0, the MSI/STBC subfield is reserved.</p> <p>If the Unsolicited MFB subfield is 1 and the MFB does not contain the value representing “no feedback is present,” the MSI/STBC field contains the Compressed MSI and STBC Indication subfields as shown in Figure 8-8b.</p> <p>The STBC Indication subfield indicates whether the estimate in the MFB subfield is computed based on a PPDU using STBC encoding: Set to 0 if the PPDU was not STBC encoded Set to 1 if the PPDU was STBC encoded</p> <p>The Compressed MSI subfield contains a sequence number that identifies the specific MCS feedback request. It is in the range 0 to 3 if STBC Indication equals 0 or in the range 0 to 2 if STBC Indication equals 1.</p> <p>Otherwise, the MSI/STBC subfield is reserved.</p>

Table 8-13a—VHT variant HT Control field subfields (continued)

Subfield	Meaning	Definition
MFSI/GID-L	MFB sequence identifier/LSBs of group ID	<p>If the Unsolicited MFB subfield is 0, the MFSI/GID-L subfield contains the received value of MSI contained in the frame to which the MFB information refers.</p> <p>If the Unsolicited MFB subfield is 1, the MFB does not contain the value representing “no feedback is present,” and the MFB is estimated from a VHT MU PPDU, then the MFSI/GID-L subfield contains the lowest 3 bits of group ID of that PPDU from which the MFB was estimated (bit 0 of the group ID appears in the lowest numbered bit of the field MFSI/GID-L). If the unsolicited MFB is estimated from an SU PPDU, the MFSI/GID-L subfield is set to all ones.</p> <p>Otherwise, this subfield is reserved.</p>
MFB	NUM_STS, VHT-MCS, BW and SNR feedback	MFB subfield is interpreted as defined in Table 8-13b. This subfield contains the recommended MFB. The combination of VHT-MCS=15 and NUM_STS=7 indicates that no feedback is present.
GID-H	MSBs of group ID	<p>If the Unsolicited MFB subfield is 1, the MFB does not contain the value representing “no feedback is present,” and the unsolicited MFB is estimated from a VHT MU PPDU, then the GID-H subfield contains the highest 3 bits of group ID of the PPDU from which the unsolicited MFB was estimated (bit 3 of the group ID appears in the lowest numbered bit of the field GID-H). If the unsolicited MFB is estimated from an SU PPDU, the GID-H subfield is set to all ones.</p> <p>Otherwise, this subfield is reserved.</p>
Coding Type	Coding type of the measured PPDU	<p>If the Unsolicited MFB subfield is 1 and the MFB does not contain the value representing “no feedback is present,” the Coding Type subfield contains the Coding information (0 for BCC and 1 for LDPC) of the PPDU from which the unsolicited MFB was estimated.</p> <p>Otherwise, this subfield is reserved.</p>
FB Tx Type	Transmission type of the measured PPDU	<p>If the Unsolicited MFB subfield is 1, the MFB does not contain the value representing “no feedback is present,” and FB Tx Type subfield is 0, then the unsolicited MFB is estimated from a VHT PPDU with RXVECTOR parameter BEAMFORMED equal to 0.</p> <p>If the Unsolicited MFB subfield is 1, the MFB does not contain the value representing “no feedback is present,” and the FB Tx Type subfield is 1, then the unsolicited MFB is estimated from a VHT PPDU with RXVECTOR parameter BEAMFORMED equal to 1.</p> <p>Otherwise, this subfield is reserved.</p>
Unsolicited MFB	Unsolicited VHT-MCS feedback indicator	<p>Set to 1 if the MFB is not a response to an MRQ.</p> <p>Set to 0 if the MFB is a response to an MRQ.</p>

The format of the MSI/STBC subfield when the Unsolicited subfield is 1 is shown in Figure 8-8b.

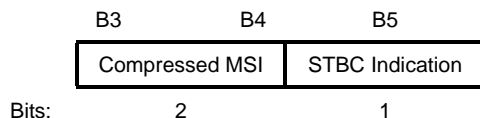

Figure 8-8b—MSI/STBC subfield when the Unsolicited MFB subfield is 1

The format of the MFB subfield in the VHT variant HT Control field is shown in Figure 8-8c.

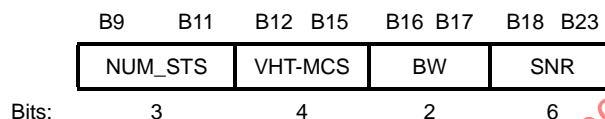

Figure 8-8c—MFB subfield in the VHT variant HT Control field

The subfields of the MFB subfield in the VHT variant HT Control field are defined in Table 8-13b.

Table 8-13b—MFB subfield in the VHT variant HT Control field

Subfield	Meaning	Definition
NUM_STS	Recommended NUM_STS	Indicates the recommended NUM_STS as defined in 9.28.3. The NUM_STS subfield contains an unsigned integer representing the number of space-time streams minus 1.
VHT-MCS	Recommended VHT-MCS	Indicates the recommended VHT-MCS as defined in 9.28.3. The VHT-MCS subfield contains an unsigned integer in the range 0 to 9 representing a VHT-MCS Index value (defined in 22.5).
BW	Bandwidth of the recommended VHT-MCS	If the Unsolicited MFB subfield is 1, the BW subfield indicates the bandwidth for which the recommended VHT-MCS is intended, as defined in 9.28.3: Set to 0 for 20 MHz Set to 1 for 40 MHz Set to 2 for 80 MHz Set to 3 for 160 MHz and 80+80 MHz. If the Unsolicited MFB subfield is 0, the BW subfield is reserved.
SNR	Average SNR	Indicates the average SNR, which is an SNR averaged over data subcarriers and space-time streams. The SNR is averaged over all the space-time streams and data subcarriers and is encoded as a 6-bit twos complement number of SNR_average - 22, where SNR_average is the sum of the values of SNR per frequency tone (in decibels) per space-time stream divided by the product of the number of space-time streams, as indicated in the NUM_STS subfield, and the number of frequency tones represented in the bandwidth in which the MFB was estimated. This encoding covers the SNR range from -10 dB to 53 dB in 1 dB steps.

8.2.4.7 Frame Body field

8.2.4.7.1 General

Change 8.2.4.7.1, including inserting a new table (Table 8-13c), as follows:

The Frame Body is a variable-length field that contains information specific to individual frame types and subtypes. The minimum length of the frame body is 0 octets. The maximum length of the frame body is defined by the maximum length MSDU plus the length of Mesh Control field as defined in 8.2.4.7.3, if present, plus any overhead for encryption as defined in Clause 11, or by the maximum length A-MSDU plus any overhead for encryption as defined in Clause 11, constrained or affected by the following:

- The maximum MMPDU, MSDU, A-MSDU, and MPDU sizes supported by the recipient(s) for the PPDU format in use, as specified in Table 8-13c
- The maximum PPDU duration (e.g., HT MF L-SIG L LENGTH, HT GF, VHT, or DMG aPPDUMaxTime (see Table 8-13c); any nonzero TXOP Limit; any regulatory constraints (e.g., CS4-msBehavior))
- The fields present in the MAC header (e.g., QoS Control, Address 4, HT Control)
- The presence of security encapsulation (e.g., TKIP, CCMP or GCMP Header and MIC)
- The presence of Mesh Control fields (see 8.2.4.7.2)

NOTE 1—In an A-MSDU, the Mesh Control field is located in the A-MSDU Subframe Header (see Figure 8-33). In an MMPDU, the Mesh Control field is located within the MMPDU (see 8.5.18). Such Mesh Control fields need to be taken into account if a maximum A-MSDU or MMPDU size constraint applies as well as if a maximum MPDU size constraint applies.

NOTE 2—TKIP is not allowed with A-MSDUs (see 11.1.6) or MMPDUs (see 11.4.4.1) and, therefore, need not be taken into account if a maximum A-MSDU or MMPDU size constraint applies.

Table 8-13c—Maximum data unit sizes (in octets) and durations (in microseconds)

	Non-HT non-VHT non-DMG PPDU and non-HT duplicate PPDU	HT PPDU	VHT PPDU	DMG PPDU
MMPDU size	2304	2304	See NOTE 1	2304
MSDU size	2304	2304	2304	7920
A-MSDU size	3839 or 4065 (see NOTE 2) or 7935 (HT STA, see also Table 8-124) or N/A (non-HT STA, see also 9.11)	3839 or 7935 (see also Table 8-124)	See NOTE 3	7935
MPDU size	See NOTE 4	See NOTE 5	3895 or 7991 or 11 454 (see also Table 8-183v)	See NOTE 5
PSDU size (see NOTE 7)	2 ¹³ -1 (Clause 16, see Table 16-2) 2 ¹² -1 (others, see Table 17-5, Table 18-7, Table 19-8)	2 ¹⁶ -1 (see Table 20-25)	4 692 480 (~2 ^{22.16}) (see Table 22-29)	2 ¹⁸ -1 (see Table 21-17)

Table 8-13c—Maximum data unit sizes (in octets) and durations (in microseconds) (continued)

	Non-HT non-VHT non-DMG PPDU and non-HT duplicate PPDU	HT PPDU	VHT PPDU	DMG PPDU
PPDU duration (see NOTE 7)	See NOTE 6	5484 (HT_MF; see 9.23.4) or 10 000 (HT_GF; see Table 20-25)	5484 (see Table 22-29)	2000 (see Table 21-31)
NOTE 1—No direct constraint on the maximum MMPDU size; indirectly constrained by the maximum MPDU size (see 8.3.3.1).				
NOTE 2—Indirect constraint from the maximum PSDU size: $2^{12}-1$ octets minus the minimum QoS Data MPDU overhead (26 octets for the MAC header and 4 octets for the FCS).				
NOTE 3—No direct constraint on the maximum A-MSDU size; indirectly constrained by the maximum MPDU size.				
NOTE 4—No direct constraint on the maximum MPDU size; indirectly constrained by the maximum MSDU/MMPDU or (for HT STAs only) A-MSDU size.				
NOTE 5—No direct constraint on the maximum MPDU size; indirectly constrained by the maximum A-MSDU size.				
NOTE 6—No direct constraint on the maximum duration, but an L_LENGTH value above 2332 might not be supported by some receivers (see last NOTE in 9.23.4).				
NOTE 7—The values for maximum PSDU size and maximum PPDU duration are informative only. References to the normative requirements are provided.				

8.2.5 Duration/ID field (QoS STA)

8.2.5.1 General

Change the third paragraph of 8.2.5.1 as follows:

All times are calculated in microseconds. If a calculated duration includes a fractional microsecond, that value inserted in the Duration/ID field is rounded up to the next higher integer. If a calculated duration results in a negative value, the value of the Duration/ID field is 0.

8.2.5.2 Setting for single and multiple protection under enhanced distributed channel access (EDCA)

Change the first paragraph of 8.2.5.2 as follows:

Within a frame (excluding data frames containing QoS CF-Poll, PSMP frames, and frames that have the RDG/More PPDU subfield equal to 1) transmitted under EDCA by a STA that initiates a TXOP, there are two classes of duration settings: single protection and multiple protection. In single protection, the value of the Duration/ID field of the frame can set a NAV value at receiving STAs that protects up to the end of any following data, management, or response frame plus any additional overhead frames as described below. In multiple protection, the value of the Duration/ID field of the frame can set a NAV that protects up to the estimated end of a sequence of multiple frames. Frames that have the RDG/More PPDU subfield equal to 1 always use multiple protection. PSMP frames always use multiple protection. The STA selects between single and multiple protection when it transmits the first frame of a TXOP. All subsequent frames transmitted by the STA in the same TXOP use the same class of duration settings. VHT NDP Announcement frames and Beamforming Report Poll frames always use multiple protection settings.

Change item b)2) in the ordered list of the second paragraph of 8.2.5.2 as follows:

- b) Multiple protection settings. The Duration/ID field is set to a value D as follows:
- 2) ~~Else if $T_{TXOP} = 0$ and $T_{END_NAV} > 0$, then $D = T_{END_NAV} - T_{PPDU}$~~
 - 2) Else if $T_{TXOP} = 0$ and $T_{END_NAV} > 0$, then $D = \max(0, T_{END_NAV} - T_{PPDU})$

Change the following descriptions in the variable list in item b) of the second paragraph of 8.2.5.2:

$T_{SINGLE-MSDU}$ is the estimated time required for the transmission of the allowed frame exchange sequence defined in ~~8.4.2.34~~9.19.2.2 (for a TXOP limit value of 0), including applicable IFS durations

$T_{PENDING}$ is the estimated time required for the transmission of

- Pending MPDUs of the same AC
- Any associated immediate response frames
- Any HT NDP, VHT NDP, or Beamforming Report Poll frame transmissions and explicit feedback response frames
- Applicable IFS durations
- Any RDG

Insert the following paragraph at the end of 8.2.5.2:

The estimated time required for transmission of a VHT Compressed Beamforming frame response is determined by assuming the following:

- All feedback segments (as defined in 9.31.5.3) are transmitted, even if a Beamforming Report Poll frame is used and not all the bits in the included Feedback Segment Retransmission Bitmap field are equal to 1.
- The subfield values of the VHT MIMO Control field are as follows:
 - The Feedback Type, Nr Index, and Channel Width fields are as specified in 9.31.5.
 - The Nc Index field is as specified in 9.31.5 if the Feedback Type field is MU, or to the greatest value allowed by 9.31.5 if the Feedback Type field is SU.
 - The Grouping field indicates no grouping.
 - The Codebook Information field has the value 1.

NOTE—If a TXOP includes the transmission of a VHT Compressed Beamforming frame by the TXOP responder, the TXOP holder can, if the duration estimates prove excessive, indicate truncation of the TXOP by using a CF-End frame, provided that the remaining duration of the TXOP after the transmission of the last frame can accommodate the CF-End frame (see 9.19.2.7).

8.3 Format of individual frame types

8.3.1 Control frames

8.3.1.2 RTS frame format

Change the third paragraph of 8.3.1.2 as follows:

The TA field value is the address of the STA transmitting the RTS frame or a bandwidth signaling TA. In an RTS frame transmitted by a VHT STA in a non-HT or non-HT duplicate format and where the scrambling sequence carries the TXVECTOR parameters CH BANDWIDTH IN NON HT and DYN BANDWIDTH IN NON HT (see 9.3.2.5a), the TA field value is a bandwidth signaling TA.

8.3.1.3 CTS frame format

Change the second paragraph of 8.3.1.3 as follows:

When the CTS frame ~~follows~~ is a response to an RTS frame, the value of the RA field of the CTS frame is the address copied from the TA field of the immediately previous RTS frame to which the CTS is a response with the Individual/Group bit forced to the value 0. When the CTS is the first frame in a frame exchange, the RA field is set to the MAC address of the transmitter.

8.3.1.4 ACK frame format

Change the second paragraph of 8.3.1.4 as follows:

The value of the RA field of the ACK frame is copied the non-bandwidth signaling TA from the Address 2 field of the immediately previous individually addressed data, management, BlockAckReq, BlockAck, or PS-Poll frames.

8.3.1.5 PS-Poll frame format

Change the second paragraph of 8.3.1.5 as follows:

The BSSID is the address of the STA contained in the AP. The TA field value is the address of the STA transmitting the frame or a bandwidth signaling TA. In a PS-Poll frame transmitted by a VHT STA in a non-HT or non-HT duplicate format and where the scrambling sequence carries the TXVECTOR parameter CH BANDWIDTH IN NON HT, the TA field value is a bandwidth signaling TA. The AID is the value assigned to the STA transmitting the frame by the AP in the association response frame that established that STA's current association.

8.3.1.6 CF-End frame format

Change the fifth paragraph of 8.3.1.6 as follows:

When transmitted by a non-DMG STA, the BSSID (TA) field is set to the address of the STA contained in the AP except that the Individual/Group bit of the BSSID (TA) field is set to 1 in a CF-End frame transmitted by a VHT STA to a VHT AP in a non-HT or non-HT duplicate format to indicate that the scrambling sequence carries the TXVECTOR parameter CH BANDWIDTH IN NON HT. When transmitted by a DMG STA, the TA field is the MAC address of the STA transmitting the frame.

8.3.1.8 BlockAckReq frame format

8.3.1.8.1 Overview

Change the fourth paragraph of 8.3.1.8.1 as follows:

The TA field value is the address of the STA transmitting the BlockAckReq frame or a bandwidth signaling TA. In a BlockAckReq frame transmitted by a VHT STA in a non-HT or non-HT duplicate format and where the scrambling sequence carries the TXVECTOR parameter CH BANDWIDTH IN NON HT, the TA field value is a bandwidth signaling TA.

8.3.1.9 BlockAck frame format

8.3.1.9.1 Overview

Change the fourth paragraph of 8.3.1.9.1 as follows:

The TA field value is the address of the STA transmitting the BlockAck frame or a bandwidth signaling TA in the context of HT-delayed Block Ack. In a BlockAck frame transmitted in the context of HT-delayed Block Ack by a VHT STA in a non-HT or non-HT duplicate format and where the scrambling sequence carries the TXVECTOR parameter CH BANDWIDTH IN NON HT, the TA field value is a bandwidth signaling TA.

Insert the following subclauses, 8.3.1.20 and 8.3.1.21 (including Figure 8-29j to Figure 8-29m and Table 8-18a), after 8.3.1.19:

8.3.1.20 VHT NDP Announcement frame format

The frame format of the VHT NDP Announcement frame is shown in Figure 8-29j.

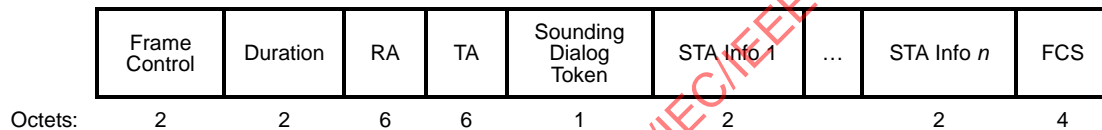

Figure 8-29j—VHT NDP Announcement frame format

The Duration field is set as defined in 8.2.5.

The VHT NDP Announcement frame contains at least one STA Info field. If the VHT NDP Announcement frame contains only one STA Info field, then the RA field value is the address of the STA identified by the AID in the STA Info field. If the VHT NDP Announcement frame contains more than one STA Info field, then the RA field value is the broadcast address.

The TA field value is the address of the STA transmitting the VHT NDP Announcement frame or a bandwidth signaling TA. In a VHT NDP Announcement frame transmitted by a VHT STA in a non-HT or non-HT duplicate format and where the scrambling sequence carries the TXVECTOR parameter CH_BANDWIDTH_IN_NON_HT, the TA field value is a bandwidth signaling TA.

The format of the Sounding Dialog Token field is shown in Figure 8-29k.

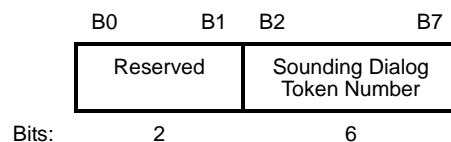

Figure 8-29k—Sounding Dialog Token field

The Sounding Dialog Token Number subfield in the Sounding Dialog Token field contains a value selected by the beamformer to identify the VHT NDP Announcement frame.

The format of the STA Info field is shown in Figure 8-29l.

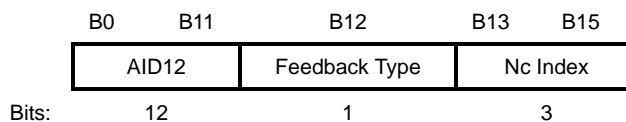

Figure 8-29l—STA Info field

The subfields in the STA Info field are described in Table 8-18a.

Table 8-18a—STA Info subfields

Field	Description
AID12	Contains the 12 least significant bits of the AID of a STA expected to process the following VHT NDP and prepare the sounding feedback. Equal to 0 if the STA is an AP, mesh STA, or STA that is a member of an IBSS.
Feedback Type	Indicates the type of feedback requested. Set to 0 for SU. Set to 1 for MU.
Nc Index	If the Feedback Type field indicates MU, then Nc Index indicates the number of columns, N_c , in the Compressed Beamforming Feedback Matrix subfield minus 1: Set to 0 to request $N_c = 1$ Set to 1 to request $N_c = 2$... Set to 7 to request $N_c = 8$ Reserved if the Feedback Type field indicates SU.

8.3.1.21 Beamforming Report Poll frame format

The Beamforming Report Poll frame is shown in Figure 8-29m.

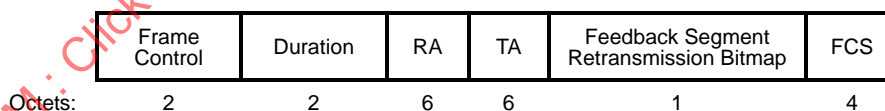

Figure 8-29m—Beamforming Report Poll frame format

The Duration field is set as defined in 8.2.5.

The RA field value is the address of the intended recipient.

The TA field value is the address of the STA transmitting the Beamforming Report Poll or a bandwidth signaling TA. In a Beamforming Report Poll frame transmitted by a VHT STA in a non-HT or non-HT duplicate format and where the scrambling sequence carries the TXVECTOR parameter CH_BANDWIDTH_IN_NON_HT, the TA field value is a bandwidth signaling TA.

The Feedback Segment Retransmission Bitmap field indicates the requested feedback segments of a VHT Compressed Beamforming report (see 9.31.5.3). If the bit in position n ($n=0$ for LSB and $n=7$ for MSB) is 1, then the feedback segment with the Remaining Feedback Segments subfield in the VHT MIMO Control field equal to n is requested. If the bit in position n is 0, then the feedback segment with the Remaining Feedback Segments subfield in the VHT MIMO Control field equal to n is not requested.

8.3.2 Data frames

8.3.2.1 Data frame format

Change Figure 8-30 as follows:

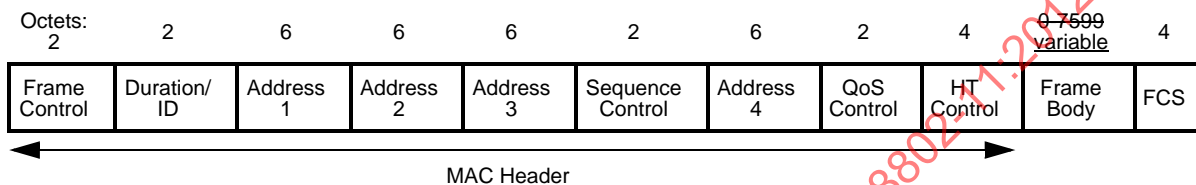

Figure 8-30—Data frame

8.3.2.2 Aggregate MSDU (A-MSDU) format

8.3.2.2.1 General

Change Figure 8-32 as follows:

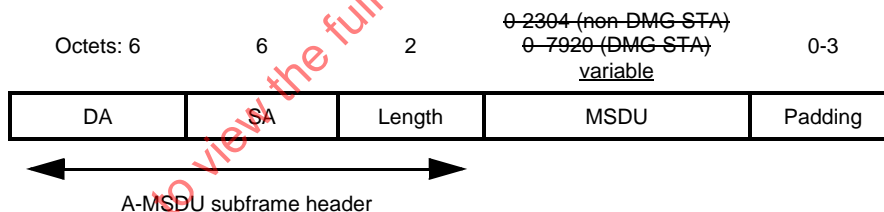

Figure 8-32—Basic A-MSDU subframe structure

8.3.3 Management frames

8.3.3.1 Format of management frames

Change the first paragraph and note in 8.3.3.1 as follows:

The format of a management frame is defined in Figure 8-34. The Frame Control, Duration, Address 1, Address 2, Address 3, and Sequence Control fields are present in all management frame subtypes. The In an MMPDU carried in one or more non-VHT PPDU the maximum unencrypted MMPDU size, excluding the MAC header and FCS, is 2304 octets is specified in Table 8-13c. In an MMPDU carried in one or more PPDU(s), all of which are VHT PPDU(s), the maximum MMPDU size specified in Table 8-13c is the maximum MPDU size supported by the recipient(s) less the shortest management frame MAC header and

FCS. In an MMPDU carried in one or more PDU(s), none of which are VHT PDU(s), the maximum unencrypted MMPDU size is 2304 octets.

NOTE—In an MMPDU carried in one or more PDUs, all of which are VHT PDUs, the presence of encryption overhead (i.e., the MMPDU is transmitted in robust management frames) or an HT Control field might cause an MMPDU to be fragmented that would not otherwise need to be fragmented.

Change Figure 8-34 as follows:

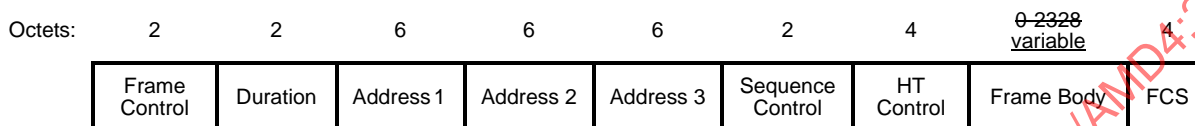

Figure 8-34—Management frame format

Delete the following note in 8.3.3.1:

NOTE—The maximum frame body size shown in Figure 8-34 is for GCMP encryption with a maximum size MMPDU (note TKIP encryption is not allowed and any Mesh Control field is held within the MMPDU, not as a separate header). The frame body size might be greater if a vendor-specific cipher suite is used.

8.3.3.2 Beacon frame format

Insert the following rows into Table 8-20 before the Last row:

Table 8-20—Beacon frame body

Order	Information	Notes
60	VHT Capabilities	The VHT Capabilities element is present when the dot11VHTOptionImplemented is true.
61	VHT Operation	The VHT Operation element is present when the dot11VHTOptionImplemented is true; otherwise, it is not present.
62	VHT Transmit Power Envelope element	One VHT Transmit Power Envelope element is present for each distinct value of the Local Maximum Transmit Power Unit Interpretation subfield that is supported for the BSS if both of the following conditions are met: <ul style="list-style-type: none"> — dot11VHTOptionImplemented is true; — Either dot11SpectrumManagementRequired is true or dot11RadioMeasurementActivated is true. Otherwise, this parameter is not present.
63	Channel Switch Wrapper element	The Channel Switch Wrapper element is optionally present if dot11VHTOptionImplemented is true and at least one of a Channel Switch Announcement element or an Extended Channel Switch Announcement element is also present in the Beacon frame and the Channel Switch Wrapper element contains at least one subelement.
64	Extended BSS Load element	The Extended BSS Load element is optionally present if dot11QosOptionImplemented, dot11QBSSLoadImplemented and dot11VHTOptionImplemented are true.

Table 8-20—Beacon frame body

Order	Information	Notes
65	Quiet Channel	Either one Quiet Channel element containing an AP Quiet Mode field equal to 0 or one or more Quiet Channel elements each containing an AP Quiet Mode field equal to 1 are optionally present if dot11VHTOptionImplemented is true, and either dot11SpectrumManagementRequired or dot11RadioMeasurementActivated is true.
66	Operating Mode Notification	The Operating Mode Notification element is optionally present if dot11OperatingModeNotificationImplemented is true.

8.3.3.5 Association Request frame format

Insert the following rows into Table 8-22 before the Last row:

Table 8-22—Association Request frame body

Order	Information	Notes
22	VHT Capabilities	The VHT Capabilities element is present when the dot11VHTOptionImplemented is true.
23	Operating Mode Notification	The Operating Mode Notification element is optionally present if dot11OperatingModeNotificationImplemented is true.

8.3.3.6 Association Response frame format

Insert the following rows into Table 8-23 before the Last row:

Table 8-23—Association Response frame body

Order	Information	Notes
27	VHT Capabilities	The VHT Capabilities element is present when the dot11VHTOptionImplemented is true.
28	VHT Operation	The VHT Operation element is present when the dot11VHTOptionImplemented is true; otherwise, it is not present.
29	Operating Mode Notification	The Operating Mode Notification element is optionally present if dot11OperatingModeNotificationImplemented is true.

8.3.3.7 Reassociation Request frame format

Insert the following rows into Table 8-24 before the Last row:

Table 8-24—Reassociation Request frame body

Order	Information	Notes
27	VHT Capabilities	The VHT Capabilities element is present when the dot11VHTOptionImplemented is true.
28	Operating Mode Notification	The Operating Mode Notification element is optionally present if dot11OperatingModeNotificationImplemented is true.

8.3.3.8 Reassociation Response frame format

Insert the following rows into Table 8-25 before the Last row:

Table 8-25—Reassociation Response frame body

Order	Information	Notes
31	VHT Capabilities	The VHT Capabilities element is present when the dot11VHTOptionImplemented is true.
32	VHT Operation	The VHT Operation element is present when the dot11VHTOptionImplemented is true; otherwise, it is not present.
33	Operating Mode Notification	The Operating Mode Notification element is optionally present if dot11OperatingModeNotificationImplemented is true.

8.3.3.9 Probe Request frame format

Insert the following row into Table 8-26 before the Last row:

Table 8-26—Probe Request frame body

Order	Information	Notes
17	VHT Capabilities	The VHT Capabilities element is present when the dot11VHTOptionImplemented is true.

8.3.3.10 Probe Response frame format

Insert the following rows into Table 8-27 before the Last-1 row:

Table 8-27—Probe Response frame body

Order	Information	Notes
62	VHT Capabilities	The VHT Capabilities element is present when the dot11VHTOptionImplemented is true.
63	VHT Operation	The VHT Operation element is present when the dot11VHTOptionImplemented is true; otherwise, it is not present.
64	VHT Transmit Power Envelope element	One VHT Transmit Power Envelope element is present for each distinct value of the Local Maximum Transmit Power Unit Interpretation subfield that is supported for the BSS if both of the following conditions are met: <ul style="list-style-type: none"> — dot11VHTOptionImplemented is true; — Either dot11SpectrumManagementRequired is true or dot11RadioMeasurementActivated is true. Otherwise, this parameter is not present.
65	Channel Switch Wrapper element	The Channel Switch Wrapper element is optionally present if dot11VHTOptionImplemented is true and at least one Channel Switch Announcement element or Extended Channel Switch Announcement element is also present in the Beacon frame and the Channel Switch Wrapper element contains at least one subelement.
66	Extended BSS Load element	The Extended BSS Load element is optionally present if dot11QosOptionImplemented, dot11QBSSLoadImplemented and dot11VHTOptionImplemented are true.
67	Quiet Channel	Either one Quiet Channel element containing an AP Quiet Mode field equal to 0 or one or more Quiet Channel elements each containing an AP Quiet Mode field equal to 1 are optionally present if dot11VHTOptionImplemented is true, and either dot11SpectrumManagementRequired or dot11RadioMeasurementActivated is true.
68	Operating Mode Notification	The Operating Mode Notification element is optionally present if dot11OperatingModeNotificationImplemented is true.

8.4 Management and Extension frames body components

8.4.1 Fields that are not information elements

8.4.1.9 Status Code field

Insert the following row into Table 8-37 in numeric order, and change the reserved values accordingly:

Table 8-37—Status codes

Status code	Name	Meaning
104		Association denied because the requesting STA does not support VHT features.

8.4.1.11 Action field

Insert the following row into Table 8-38 in numeric order, and change the reserved values accordingly:

Table 8-38—Category values

Code	Meaning	See subclause	Robust	Group addressed privacy	Action frame
21	VHT	8.5.23	No	No	

8.4.1.27 CSI Report field

Change the first paragraph of 8.4.1.27 as follows:

The CSI Report field is used by the CSI frame (see 8.5.12.6) to carry explicit channel state information to a transmit HT beamformer, as described in 9.29.3.

8.4.1.28 Noncompressed Beamforming Report field

Change the first paragraph of 8.4.1.28 as follows:

The Noncompressed Beamforming Report field is used by the Noncompressed Beamforming frame to carry explicit feedback in the form of noncompressed beamforming feedback matrices V for use by a transmit HT beamformer to determine steering matrices Q , as described in 9.29.3 and 20.3.12.3.

Change the fourth paragraph of 8.4.1.28 as follows:

The SNR values in Table 8-46 and Table 8-47 are encoded as an 8-bit twos complement value of $4 \times (\text{SNR_average} - 22)$, where SNR_average is the sum of the values of SNR per tone (in decibels) divided by the number of tones represented. This encoding covers the SNR range from -10 dB to 53.75 dB in 0.25 dB steps. The SNR in space-time stream i corresponds to the SNR associated with the column i of the beamforming feedback matrix V . Each SNR corresponds to the predicted SNR at HT beamformee when the HT beamformer applies the matrix V .

8.4.1.29 Compressed Beamforming Report field

Change the first paragraph of 8.4.1.29 as follows:

The Compressed Beamforming Report field is used by the Compressed Beamforming frame (see 8.5.12.8) to carry explicit feedback information in the form of angles representing compressed beamforming feedback matrices V for use by a transmit HT beamformer to determine steering matrices Q , as described in 9.29.3 and 20.3.12.3.

Change the seventh paragraph of 8.4.1.29 as follows:

The SNR values in Table 8-50 and Table 8-51 are encoded as an 8-bit two's complement value of $4 \times (\text{SNR_average} - 22)$, where SNR_average is the sum of the values of SNR per tone (in decibels) divided by the number of tones represented. This encoding covers the SNR range from -10 dB to 53.75 dB in 0.25 dB steps. Each SNR value per tone in stream i (before being averaged) corresponds to the SNR associated with the column i of the beamforming feedback matrix V determined at the HT beamformee. Each SNR corresponds to the predicted SNR at the HT beamformee when the HT beamformer applies the matrix V .

8.4.1.32 Rate Identification field

Change 8.4.1.32, including inserting a new figure (Figure 8-70a), as follows:

The Rate Identification field is 4 octets in length and contains the rate identification information for a frame that is not the current frame transmitted or received by a STA. This information allows services to exchange frame rate information prior to use of the frames that use the rate specified by the Rate Identification field. The contents of the field is defined in Figure 8-69.

Figure 8-69 remains unchanged.

The Mask field specifies which other fields in the Rate Identification field are used by a STA. The format of the Mask field is shown in Figure 8-70.

Figure 8-70 remains unchanged.

The MCS Selector field ~~set to value 0~~ indicates that the MCS Index field is reserved. The MCS Selector field ~~set to value 1~~ indicates that the MCS Index field specifies an index value that is taken from Table 20-30 through Table 20-33 and Table 20-39 through Table 20-41 in 20.6. The MCS Selector field ~~set to value 2~~ indicates that the MCS Index field specifies an index value that is taken from Table 20-34 through Table 20-38 and Table 20-43 through Table 20-44 in 20.6.

The MCS Selector field value 3 indicates that the MCS Index field specifies values that are taken from Table 22-30 through Table 22-37, indicating a VHT-MCS for a 20 MHz channel width.

The MCS Selector field value 4 indicates that the MCS Index field specifies values that are taken from Table 22-38 through Table 22-45, indicating a VHT-MCS for a 40 MHz channel width.

The MCS Selector field value 5 indicates that the MCS Index field specifies values that are taken from Table 22-46 through Table 22-53, indicating a VHT-MCS for an 80 MHz channel width.

The MCS Selector field value 6 indicates that the MCS Index field specifies values that are taken from Table 22-54 through Table 22-61, indicating a VHT-MCS for a 160 MHz or 80+80 MHz channel width.

The MCS Selector field values ~~3 to 7~~ are reserved.

The Rate Type field set to 0 indicates the Rate field is reserved. The Rate Type field set to 1 indicates the Rate field specifies a data rate that is in the basic rate set. The Rate Type field set to 2 indicates the Rate field specifies a data rate that is not in the basic rate set.

If MCS Selector is 1 or 2, the MCS Index field is a 1-octet unsigned integer that specifies the row index for one of the MCS parameter tables in 20.6.

If MCS Selector is 3, 4, 5, or 6, the MCS Index field format is as shown in Figure 8-70a. The NSS subfield indicates the number of spatial streams, and the VHT-MCS Index Row subfield indicates a value from the “VHT-MCS Index” column of Table 22-30 through Table 22-61 in 22.5 that corresponds to the channel width and N_{SS} values.

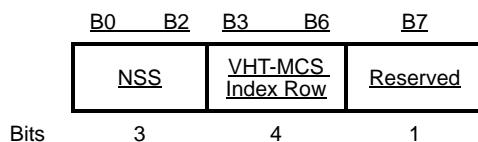

Figure 8-70a—MCS Index field format when the MCS Selector field is 3, 4, 5, or 6

The Rate field contains a 2-octet unsigned integer that specifies the PHY rate in 0.5 Mb/s units.

Insert the following subclauses, 8.4.1.47 to 8.4.1.52 (including Figure 8-80d to Figure 8-80g and Table 8-53c to Table 8-53l), after 8.4.1.46:

8.4.1.47 VHT MIMO Control field

The VHT MIMO Control field is included in every VHT Compressed Beamforming frame (see 8.5.23.2). The VHT MIMO Control field is defined in Figure 8-80d.

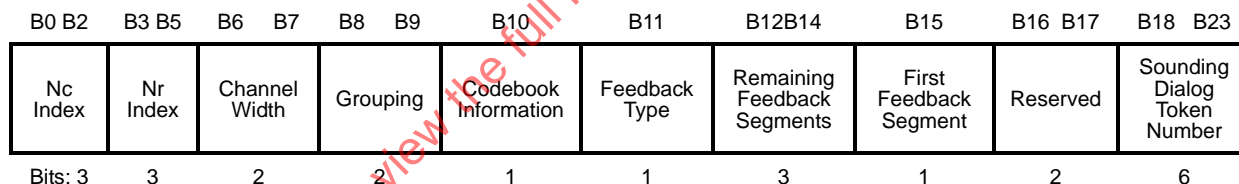

Figure 8-80d—VHT MIMO Control field

The subfields of the VHT MIMO Control field are defined in Table 8-53c.

In a VHT Compressed Beamforming frame not carrying all or part of a VHT Compressed Beamforming report (see 9.31.5 for a description of such a case), the Nc Index, Nr Index, Channel Width, Grouping, Codebook Information, Feedback Type and Sounding Dialog Token Number fields are reserved, the First Feedback Segment field is set to 0 and the Remaining Feedback Segments field is set to 7.

Table 8-53c—Subfields of the VHT MIMO Control field

Subfield	Description
Nc Index	Indicates the number of columns, N_c , in the compressed beamforming feedback matrix minus 1: Set to 0 for $N_c = 1$ Set to 1 for $N_c = 2$... Set to 7 for $N_c = 8$
Nr Index	Indicates the number of rows, N_r , in the compressed beamforming feedback matrix minus 1: Set to 0 for $N_r = 1$ Set to 1 for $N_r = 2$... Set to 7 for $N_r = 8$
Channel Width	Indicates the width of the channel in which the measurement to create the compressed beamforming feedback matrix was made: Set to 0 for 20 MHz Set to 1 for 40 MHz Set to 2 for 80 MHz Set to 3 for 160 MHz or 80+80 MHz
Grouping	Indicates the subcarrier grouping, N_g , used for the compressed beamforming feedback matrix: Set to 0 for $N_g = 1$ (No grouping) Set to 1 for $N_g = 2$ Set to 2 for $N_g = 4$ The value 3 is reserved
Codebook Information	Indicates the size of codebook entries: If Feedback Type is SU: Set to 0 for 2 bits for ψ , 4 bits for ϕ Set to 1 for 4 bits for ψ , 6 bits for ϕ If Feedback Type is MU: Set to 0 for 5 bits for ψ , 7 bits for ϕ Set to 1 for 7 bits for ψ , 9 bits for ϕ
Feedback Type	Indicates the feedback type: Set to 0 for SU Set to 1 for MU
Remaining Feedback Segments	Indicates the number of remaining feedback segments for the associated VHT Compressed Beamforming frame: Set to 0 for the last feedback segment of a segmented report or the only feedback segment of an unsegmented report. Set to a value between 1 and 6 for a feedback segment that is neither the first nor the last of a segmented report. Set to a value between 1 and 7 for a feedback segment that is not the last feedback segment of a segmented report. In a retransmitted feedback segment, the field is set to the same value associated with the feedback segment in the original transmission.
First Feedback Segment	Set to 1 for the first feedback segment of a segmented report or the only feedback segment of an unsegmented report; set to 0 if it is not the first feedback segment or if the VHT Compressed Beamforming Report field and MU Exclusive Beamforming Report field are not present in the frame. In a retransmitted feedback segment, the field is set to the same value associated with the feedback segment in the original transmission.
Sounding Dialog Token Number	The sounding dialog token from the VHT NDP Announcement frame soliciting feedback

8.4.1.48 VHT Compressed Beamforming Report field

The VHT Compressed Beamforming Report field is used by the VHT Compressed Beamforming feedback (see 8.5.23.2) to carry explicit feedback information in the form of angles representing compressed beamforming feedback matrices V for use by a transmit beamformer to determine steering matrices Q , as described in 9.29.3 and 20.3.12.3.

The size of the VHT Compressed Beamforming Report field depends on the values in the VHT MIMO Control field. The VHT Compressed Beamforming Report field contains VHT Compressed Beamforming Report information or successive (possibly zero-length) portions thereof in the case of segmented VHT Compressed Beamforming feedback (see 9.31.5). VHT Compressed Beamforming Report information is always included in the VHT Compressed Beamforming feedback.

The VHT Compressed Beamforming Report information contains the channel matrix elements indexed, first, by matrix angles in the order shown in Table 8-53d and, second, by data subcarrier index from lowest frequency to highest frequency. The explanation on how these angles are generated from the beamforming feedback matrix V is given in 20.3.12.3.6. In Table 8-53d,

- N_c is the number of columns in a compressed beamforming feedback matrix determined by the N_c Index field of the VHT MIMO Control field,
- N_r is the number of rows in a compressed beamforming feedback matrix determined by the N_r Index field of the VHT MIMO Control field.

Table 8-53d—Order of angles in the Compressed Beamforming Feedback Matrix subfield

Size of V ($N_r \times N_c$)	Number of angles (N_a)	The order of angles in the Compressed Beamforming Feedback Matrix subfield
2×1	2	ϕ_{11}, ψ_{21}
2×2	2	ϕ_{11}, ψ_{21}
3×1	4	$\phi_{11}, \phi_{21}, \psi_{21}, \psi_{31}$
3×2	6	$\phi_{11}, \phi_{21}, \psi_{21}, \psi_{31}, \phi_{22}, \psi_{32}$
3×3	6	$\phi_{11}, \phi_{21}, \psi_{21}, \psi_{31}, \phi_{22}, \psi_{32}$
4×1	6	$\phi_{11}, \phi_{21}, \phi_{31}, \psi_{21}, \psi_{31}, \psi_{41}$
4×2	10	$\phi_{11}, \phi_{21}, \phi_{31}, \psi_{21}, \psi_{31}, \psi_{41}, \phi_{22}, \phi_{32}, \psi_{32}, \psi_{42}$
4×3	12	$\phi_{11}, \phi_{21}, \phi_{31}, \psi_{21}, \psi_{31}, \psi_{41}, \phi_{22}, \phi_{32}, \psi_{32}, \psi_{42}, \phi_{33}, \psi_{43}$
4×4	12	$\phi_{11}, \phi_{21}, \phi_{31}, \psi_{21}, \psi_{31}, \psi_{41}, \phi_{22}, \phi_{32}, \psi_{32}, \psi_{42}, \phi_{33}, \psi_{43}$
5×1	8	$\phi_{11}, \phi_{21}, \phi_{31}, \phi_{41}, \psi_{21}, \psi_{31}, \psi_{41}, \psi_{51}$
5×2	14	$\phi_{11}, \phi_{21}, \phi_{31}, \phi_{41}, \psi_{21}, \psi_{31}, \psi_{41}, \psi_{51}, \phi_{22}, \phi_{32}, \phi_{42}, \psi_{32}, \psi_{42}, \psi_{52}$
5×3	18	$\phi_{11}, \phi_{21}, \phi_{31}, \phi_{41}, \psi_{21}, \psi_{31}, \psi_{41}, \psi_{51}, \phi_{22}, \phi_{32}, \phi_{42}, \psi_{32}, \psi_{42}, \psi_{52}, \phi_{33}, \phi_{43}, \psi_{43}, \psi_{53}$
5×4	20	$\phi_{11}, \phi_{21}, \phi_{31}, \phi_{41}, \psi_{21}, \psi_{31}, \psi_{41}, \psi_{51}, \phi_{22}, \phi_{32}, \phi_{42}, \psi_{32}, \psi_{42}, \psi_{52}, \phi_{33}, \phi_{43}, \psi_{43}, \psi_{53}, \phi_{44}, \psi_{54}$
5×5	20	$\phi_{11}, \phi_{21}, \phi_{31}, \phi_{41}, \psi_{21}, \psi_{31}, \psi_{41}, \psi_{51}, \phi_{22}, \phi_{32}, \phi_{42}, \psi_{32}, \psi_{42}, \psi_{52}, \phi_{33}, \phi_{43}, \psi_{43}, \psi_{53}, \phi_{44}, \psi_{54}$

Table 8-53d—Order of angles in the Compressed Beamforming Feedback Matrix subfield (continued)

Size of V ($N_r \times N_e$)	Number of angles (N_a)	The order of angles in the Compressed Beamforming Feedback Matrix subfield
6×1	10	$\phi_{11}, \phi_{21}, \phi_{31}, \phi_{41}, \phi_{51}, \psi_{21}, \psi_{31}, \psi_{41}, \psi_{51}, \psi_{61}$
6×2	18	$\phi_{11}, \phi_{21}, \phi_{31}, \phi_{41}, \phi_{51}, \psi_{21}, \psi_{31}, \psi_{41}, \psi_{51}, \psi_{61}, \phi_{22}, \phi_{32}, \phi_{42}, \phi_{52}, \psi_{32}, \psi_{42}, \psi_{52}, \psi_{62}$
6×3	24	$\phi_{11}, \phi_{21}, \phi_{31}, \phi_{41}, \phi_{51}, \psi_{21}, \psi_{31}, \psi_{41}, \psi_{51}, \psi_{61}, \phi_{22}, \phi_{32}, \phi_{42}, \phi_{52}, \psi_{32}, \psi_{42}, \psi_{52}, \psi_{62}, \phi_{33}, \phi_{43}, \phi_{53}, \psi_{43}, \psi_{53}, \psi_{63}$
6×4	28	$\phi_{11}, \phi_{21}, \phi_{31}, \phi_{41}, \phi_{51}, \psi_{21}, \psi_{31}, \psi_{41}, \psi_{51}, \psi_{61}, \phi_{22}, \phi_{32}, \phi_{42}, \phi_{52}, \psi_{32}, \psi_{42}, \psi_{52}, \psi_{62}, \phi_{33}, \phi_{43}, \phi_{53}, \psi_{43}, \psi_{53}, \psi_{63}, \phi_{44}, \phi_{54}, \psi_{54}, \psi_{64}$
6×5	30	$\phi_{11}, \phi_{21}, \phi_{31}, \phi_{41}, \phi_{51}, \psi_{21}, \psi_{31}, \psi_{41}, \psi_{51}, \psi_{61}, \phi_{22}, \phi_{32}, \phi_{42}, \phi_{52}, \psi_{32}, \psi_{42}, \psi_{52}, \psi_{62}, \phi_{33}, \phi_{43}, \phi_{53}, \psi_{43}, \psi_{53}, \psi_{63}, \phi_{44}, \phi_{54}, \psi_{54}, \psi_{64}, \phi_{55}, \psi_{65}$
6×6	30	$\phi_{11}, \phi_{21}, \phi_{31}, \phi_{41}, \phi_{51}, \psi_{21}, \psi_{31}, \psi_{41}, \psi_{51}, \psi_{61}, \phi_{22}, \phi_{32}, \phi_{42}, \phi_{52}, \psi_{32}, \psi_{42}, \psi_{52}, \psi_{62}, \phi_{33}, \phi_{43}, \phi_{53}, \psi_{43}, \psi_{53}, \psi_{63}, \phi_{44}, \phi_{54}, \psi_{54}, \psi_{64}, \phi_{55}, \psi_{65}$
7×1	12	$\phi_{11}, \phi_{21}, \phi_{31}, \phi_{41}, \phi_{51}, \phi_{61}, \psi_{21}, \psi_{31}, \psi_{41}, \psi_{51}, \psi_{61}, \psi_{71}$
7×2	22	$\phi_{11}, \phi_{21}, \phi_{31}, \phi_{41}, \phi_{51}, \phi_{61}, \psi_{21}, \psi_{31}, \psi_{41}, \psi_{51}, \psi_{61}, \psi_{71}, \phi_{22}, \phi_{32}, \phi_{42}, \phi_{52}, \phi_{62}, \psi_{32}, \psi_{42}, \psi_{52}, \psi_{62}, \psi_{72}$
7×3	30	$\phi_{11}, \phi_{21}, \phi_{31}, \phi_{41}, \phi_{51}, \phi_{61}, \psi_{21}, \psi_{31}, \psi_{41}, \psi_{51}, \psi_{61}, \psi_{71}, \phi_{22}, \phi_{32}, \phi_{42}, \phi_{52}, \phi_{62}, \psi_{32}, \psi_{42}, \psi_{52}, \psi_{62}, \psi_{72}, \phi_{33}, \phi_{43}, \phi_{53}, \phi_{63}, \psi_{43}, \psi_{53}, \psi_{63}, \psi_{73}$
7×4	36	$\phi_{11}, \phi_{21}, \phi_{31}, \phi_{41}, \phi_{51}, \phi_{61}, \psi_{21}, \psi_{31}, \psi_{41}, \psi_{51}, \psi_{61}, \psi_{71}, \phi_{22}, \phi_{32}, \phi_{42}, \phi_{52}, \phi_{62}, \psi_{32}, \psi_{42}, \psi_{52}, \psi_{62}, \psi_{72}, \phi_{33}, \phi_{43}, \phi_{53}, \phi_{63}, \psi_{43}, \psi_{53}, \psi_{63}, \psi_{73}, \phi_{44}, \phi_{54}, \phi_{64}, \psi_{54}, \psi_{64}, \psi_{74}$
7×5	40	$\phi_{11}, \phi_{21}, \phi_{31}, \phi_{41}, \phi_{51}, \phi_{61}, \psi_{21}, \psi_{31}, \psi_{41}, \psi_{51}, \psi_{61}, \psi_{71}, \phi_{22}, \phi_{32}, \phi_{42}, \phi_{52}, \phi_{62}, \psi_{32}, \psi_{42}, \psi_{52}, \psi_{62}, \psi_{72}, \phi_{33}, \phi_{43}, \phi_{53}, \phi_{63}, \psi_{43}, \psi_{53}, \psi_{63}, \psi_{73}, \phi_{44}, \phi_{54}, \phi_{64}, \psi_{54}, \psi_{64}, \psi_{74}, \phi_{55}, \phi_{65}, \psi_{65}, \psi_{75}$
7×6	42	$\phi_{11}, \phi_{21}, \phi_{31}, \phi_{41}, \phi_{51}, \phi_{61}, \psi_{21}, \psi_{31}, \psi_{41}, \psi_{51}, \psi_{61}, \psi_{71}, \phi_{22}, \phi_{32}, \phi_{42}, \phi_{52}, \phi_{62}, \psi_{32}, \psi_{42}, \psi_{52}, \psi_{62}, \psi_{72}, \phi_{33}, \phi_{43}, \phi_{53}, \phi_{63}, \psi_{43}, \psi_{53}, \psi_{63}, \psi_{73}, \phi_{44}, \phi_{54}, \phi_{64}, \psi_{54}, \psi_{64}, \psi_{74}, \phi_{55}, \phi_{65}, \psi_{65}, \psi_{75}, \phi_{66}, \psi_{76}$
7×7	42	$\phi_{11}, \phi_{21}, \phi_{31}, \phi_{41}, \phi_{51}, \phi_{61}, \psi_{21}, \psi_{31}, \psi_{41}, \psi_{51}, \psi_{61}, \psi_{71}, \phi_{22}, \phi_{32}, \phi_{42}, \phi_{52}, \phi_{62}, \psi_{32}, \psi_{42}, \psi_{52}, \psi_{62}, \psi_{72}, \phi_{33}, \phi_{43}, \phi_{53}, \phi_{63}, \psi_{43}, \psi_{53}, \psi_{63}, \psi_{73}, \phi_{44}, \phi_{54}, \phi_{64}, \psi_{54}, \psi_{64}, \psi_{74}, \phi_{55}, \phi_{65}, \psi_{65}, \psi_{75}, \phi_{66}, \psi_{76}$
8×1	14	$\phi_{11}, \phi_{21}, \phi_{31}, \phi_{41}, \phi_{51}, \phi_{61}, \phi_{71}, \psi_{21}, \psi_{31}, \psi_{41}, \psi_{51}, \psi_{61}, \psi_{71}, \psi_{81}$
8×2	26	$\phi_{11}, \phi_{21}, \phi_{31}, \phi_{41}, \phi_{51}, \phi_{61}, \phi_{71}, \psi_{21}, \psi_{31}, \psi_{41}, \psi_{51}, \psi_{61}, \psi_{71}, \psi_{81}, \phi_{22}, \phi_{32}, \phi_{42}, \phi_{52}, \phi_{62}, \phi_{72}, \psi_{32}, \psi_{42}, \psi_{52}, \psi_{62}, \psi_{72}, \psi_{82}$
8×3	36	$\phi_{11}, \phi_{21}, \phi_{31}, \phi_{41}, \phi_{51}, \phi_{61}, \phi_{71}, \psi_{21}, \psi_{31}, \psi_{41}, \psi_{51}, \psi_{61}, \psi_{71}, \psi_{81}, \phi_{22}, \phi_{32}, \phi_{42}, \phi_{52}, \phi_{62}, \phi_{72}, \psi_{32}, \psi_{42}, \psi_{52}, \psi_{62}, \psi_{72}, \psi_{82}, \phi_{33}, \phi_{43}, \phi_{53}, \phi_{63}, \phi_{73}, \psi_{43}, \psi_{53}, \psi_{63}, \psi_{73}, \psi_{83}$
8×4	44	$\phi_{11}, \phi_{21}, \phi_{31}, \phi_{41}, \phi_{51}, \phi_{61}, \phi_{71}, \psi_{21}, \psi_{31}, \psi_{41}, \psi_{51}, \psi_{61}, \psi_{71}, \psi_{81}, \phi_{22}, \phi_{32}, \phi_{42}, \phi_{52}, \phi_{62}, \phi_{72}, \psi_{32}, \psi_{42}, \psi_{52}, \psi_{62}, \psi_{72}, \psi_{82}, \phi_{33}, \phi_{43}, \phi_{53}, \phi_{63}, \phi_{73}, \psi_{43}, \psi_{53}, \psi_{63}, \psi_{73}, \psi_{83}, \phi_{44}, \phi_{54}, \phi_{64}, \phi_{74}, \psi_{54}, \psi_{64}, \psi_{74}, \psi_{84}$
8×5	50	$\phi_{11}, \phi_{21}, \phi_{31}, \phi_{41}, \phi_{51}, \phi_{61}, \phi_{71}, \psi_{21}, \psi_{31}, \psi_{41}, \psi_{51}, \psi_{61}, \psi_{71}, \psi_{81}, \phi_{22}, \phi_{32}, \phi_{42}, \phi_{52}, \phi_{62}, \phi_{72}, \psi_{32}, \psi_{42}, \psi_{52}, \psi_{62}, \psi_{72}, \psi_{82}, \phi_{33}, \phi_{43}, \phi_{53}, \phi_{63}, \phi_{73}, \psi_{43}, \psi_{53}, \psi_{63}, \psi_{73}, \psi_{83}, \phi_{44}, \phi_{54}, \phi_{64}, \phi_{74}, \psi_{54}, \psi_{64}, \psi_{74}, \psi_{84}, \phi_{55}, \phi_{65}, \phi_{75}, \psi_{65}, \psi_{75}, \psi_{85}$

Table 8-53d—Order of angles in the Compressed Beamforming Feedback Matrix subfield (continued)

Size of V ($Nr \times Nc$)	Number of angles (Na)	The order of angles in the Compressed Beamforming Feedback Matrix subfield
8×6	54	$\phi_{11}, \phi_{21}, \phi_{31}, \phi_{41}, \phi_{51}, \phi_{61}, \phi_{71}, \psi_{21}, \psi_{31}, \psi_{41}, \psi_{51}, \psi_{61}, \psi_{71}, \psi_{81}, \phi_{22}, \phi_{32}, \phi_{42}, \phi_{52}, \phi_{62}, \phi_{72}, \psi_{32}, \psi_{42}, \psi_{52}, \psi_{62}, \psi_{72}, \psi_{82}, \phi_{33}, \phi_{43}, \phi_{53}, \phi_{63}, \phi_{73}, \psi_{43}, \psi_{53}, \psi_{63}, \psi_{73}, \psi_{83}, \phi_{44}, \phi_{54}, \phi_{64}, \phi_{74}, \psi_{54}, \psi_{64}, \psi_{74}, \psi_{84}, \phi_{55}, \phi_{65}, \phi_{75}, \psi_{65}, \psi_{75}, \psi_{85}, \phi_{66}, \phi_{76}, \psi_{76}, \psi_{86}$
8×7	56	$\phi_{11}, \phi_{21}, \phi_{31}, \phi_{41}, \phi_{51}, \phi_{61}, \phi_{71}, \psi_{21}, \psi_{31}, \psi_{41}, \psi_{51}, \psi_{61}, \psi_{71}, \psi_{81}, \phi_{22}, \phi_{32}, \phi_{42}, \phi_{52}, \phi_{62}, \phi_{72}, \psi_{32}, \psi_{42}, \psi_{52}, \psi_{62}, \psi_{72}, \psi_{82}, \phi_{33}, \phi_{43}, \phi_{53}, \phi_{63}, \phi_{73}, \psi_{43}, \psi_{53}, \psi_{63}, \psi_{73}, \psi_{83}, \phi_{44}, \phi_{54}, \phi_{64}, \phi_{74}, \psi_{54}, \psi_{64}, \psi_{74}, \psi_{84}, \phi_{55}, \phi_{65}, \phi_{75}, \psi_{65}, \psi_{75}, \psi_{85}, \phi_{66}, \phi_{76}, \psi_{76}, \psi_{86}, \phi_{77}, \psi_{87}$
8×8	56	$\phi_{11}, \phi_{21}, \phi_{31}, \phi_{41}, \phi_{51}, \phi_{61}, \phi_{71}, \psi_{21}, \psi_{31}, \psi_{41}, \psi_{51}, \psi_{61}, \psi_{71}, \psi_{81}, \phi_{22}, \phi_{32}, \phi_{42}, \phi_{52}, \phi_{62}, \phi_{72}, \psi_{32}, \psi_{42}, \psi_{52}, \psi_{62}, \psi_{72}, \psi_{82}, \phi_{33}, \phi_{43}, \phi_{53}, \phi_{63}, \phi_{73}, \psi_{43}, \psi_{53}, \psi_{63}, \psi_{73}, \psi_{83}, \phi_{44}, \phi_{54}, \phi_{64}, \phi_{74}, \psi_{54}, \psi_{64}, \psi_{74}, \psi_{84}, \phi_{55}, \phi_{65}, \phi_{75}, \psi_{65}, \psi_{75}, \psi_{85}, \phi_{66}, \phi_{76}, \psi_{76}, \psi_{86}, \phi_{77}, \psi_{87}$

The beamforming feedback matrix V is formed by the beamformee as follows. The beamformer transmits an NDP with $N_{STS,NDP}$ space-time streams, where $N_{STS,NDP}$ may take a value between 2 and 8. Based on this NDP, the beamformee estimates the $N_{RX,BFEE} \times N_{STS,NDP}$ channel, and based on that channel it determines a $Nr \times Nc$ orthonormal matrix V , where Nr and Nc satisfy Equation (8-1).

$$Nr = N_{STS,NDP}, Nc \leq \min(N_{STS,NDP}, N_{RX,BFEE}) \tag{8-1}$$

Further restrictions on Nc are described in 9.31.5.

The angles are quantized as defined in Table 8-53e.

Table 8-53e—Quantization of angles

Quantized ψ	Quantized ϕ
$\psi = \frac{k\pi}{2^{b_\psi+1}} + \frac{\pi}{2^{b_\psi+2}} \text{ radians}$ <p>where</p> $k = 0, 1, \dots, 2^{b_\psi} - 1$ <p>b_ψ is the number of bits used to quantize ψ (defined by the Codebook Information field of the VHT MIMO Control field (see 8.4.1.47))</p>	$\phi = \frac{k\pi}{2^{b_\phi-1}} + \frac{\pi}{2^{b_\phi}} \text{ radians}$ <p>where</p> $k = 0, 1, \dots, 2^{b_\phi} - 1$ <p>b_ϕ is the number of bits used to quantize ϕ (defined by the Codebook Information field of the VHT MIMO Control field (see 8.4.1.47))</p>

The VHT Compressed Beamforming Report information has the structure and order defined in Table 8-53f, where Na is the number of angles used for the compressed beamforming feedback matrix subfield (see Table 8-53d).

Table 8-53f—VHT Compressed Beamforming Report information

Field	Size (bits)	Meaning
Average SNR of Space-Time Stream 1	8	Signal-to-noise ratio at the beamformee for space-time stream 1 averaged over all data subcarriers. See Table 8-53h.
...
Average SNR of Space-Time Stream N_c	8	Signal-to-noise ratio at the beamformee for space-time stream N_c averaged over all data subcarriers. See Table 8-53h.
Compressed Beamforming Feedback Matrix V for subcarrier $k = scidx(0)$	$Na \times (b_\psi + b_\phi) / 2$	Compressed beamforming feedback matrix as defined in Table 8-53d
Compressed Beamforming Feedback Matrix V for subcarrier $k = scidx(1)$	$Na \times (b_\psi + b_\phi) / 2$	Compressed beamforming feedback matrix as defined in Table 8-53d
Compressed Beamforming Feedback Matrix V for subcarrier $k = scidx(2)$	$Na \times (b_\psi + b_\phi) / 2$	Compressed beamforming feedback matrix as defined in Table 8-53d
...
Compressed Beamforming Feedback Matrix V for subcarrier $k = scidx(N_s - 1)$	$Na \times (b_\psi + b_\phi) / 2$	Compressed beamforming feedback matrix as defined in Table 8-53d
NOTE— $scidx()$ is defined in Table 8-53g		

N_s is the number of subcarriers for which the Compressed Beamforming Feedback Matrix subfield is sent back to the beamformer. A beamformee may choose to reduce N_s by using a method referred to as grouping, in which only a single Compressed Beamforming Feedback Matrix is reported for each group of N_g adjacent subcarriers. N_s is a function of the Channel Width and Grouping subfields in the VHT MIMO Control field (see 8.4.1.47). Table 8-53g lists N_s , the exact subcarrier indices and their order for which the Compressed Beamforming Feedback Matrix subfield is sent back. No padding is present between angles in the VHT Compressed Beamforming Report information, even if they correspond to different subcarriers. If the size of the VHT Compressed Beamforming Report information is not an integral multiple of 8 bits, up to seven zeros are appended to the end of the field to make its size an integral multiple of 8 bits.

Table 8-53g—Subcarriers for which a Compressed Beamforming Feedback Matrix subfield is sent back

Channel Width	N_g	N_s	Subcarriers for which Compressed Feedback Beamforming Matrix subfield is sent: $scidx(0), scidx(1), \dots, scidx(N_s-1)$
20 MHz	1	52	-28, -27, -26, -25, -24, -23, -22, -20, -19, -18, -17, -16, -15, -14, -13, -12, -11, -10, -9, -8, -6, -5, -4, -3, -2, -1, 1, 2, 3, 4, 5, 6, 8, 9, 10, 11, 12, 13, 14, 15, 16, 17, 18, 19, 20, 22, 23, 24, 25, 26, 27, 28 NOTE—Pilot subcarriers ($\pm 21, \pm 7$) and DC subcarrier (0) are skipped
	2	30	-28, -26, -24, -22, -20, -18, -16, -14, -12, -10, -8, -6, -4, -2, -1, 1, 2, 4, 6, 8, 10, 12, 14, 16, 18, 20, 22, 24, 26, 28
	4	16	-28, -24, -20, -16, -12, -8, -4, -1, 1, 4, 8, 12, 16, 20, 24, 28
40 MHz	1	108	-58, -57, -56, -55, -54, -52, -51, -50, -49, -48, -47, -46, -45, -44, -43, -42, -41, -40, -39, -38, -37, -36, -35, -34, -33, -32, -31, -30, -29, -28, -27, -26, -24, -23, -22, -21, -20, -19, -18, -17, -16, -15, -14, -13, -12, -10, -9, -8, -7, -6, -5, -4, -3, -2, 2, 3, 4, 5, 6, 7, 8, 9, 10, 12, 13, 14, 15, 16, 17, 18, 19, 20, 21, 22, 23, 24, 26, 27, 28, 29, 30, 31, 32, 33, 34, 35, 36, 37, 38, 39, 40, 41, 42, 43, 44, 45, 46, 47, 48, 49, 50, 51, 52, 54, 55, 56, 57, 58 NOTE—Pilot subcarriers ($\pm 53, \pm 25, \pm 11$) and DC subcarriers (0, ± 1) are skipped.
	2	58	-58, -56, -54, -52, -50, -48, -46, -44, -42, -40, -38, -36, -34, -32, -30, -28, -26, -24, -22, -20, -18, -16, -14, -12, -10, -8, -6, -4, -2, 2, 4, 6, 8, 10, 12, 14, 16, 18, 20, 22, 24, 26, 28, 30, 32, 34, 36, 38, 40, 42, 44, 46, 48, 50, 52, 54, 56, 58
	4	30	-58, -54, -50, -46, -42, -38, -34, -30, -26, -22, -18, -14, -10, -6, -2, 2, 6, 10, 14, 18, 22, 26, 30, 34, 38, 42, 46, 50, 54, 58
80 MHz	1	234	-122, -121, -120, -119, -118, -117, -116, -115, -114, -113, -112, -111, -110, -109, -108, -107, -106, -105, -104, -102, -101, -100, -99, -98, -97, -96, -95, -94, -93, -92, -91, -90, -89, -88, -87, -86, -85, -84, -83, -82, -81, -80, -79, -78, -77, -76, -74, -73, -72, -71, -70, -69, -68, -67, -66, -65, -64, -63, -62, -61, -60, -59, -58, -57, -56, -55, -54, -53, -52, -51, -50, -49, -48, -47, -46, -45, -44, -43, -42, -41, -40, -38, -37, -36, -35, -34, -33, -32, -31, -30, -29, -28, -27, -26, -25, -24, -23, -22, -21, -20, -19, -18, -17, -16, -15, -14, -13, -12, -10, -9, -8, -7, -6, -5, -4, -3, -2, 2, 3, 4, 5, 6, 7, 8, 9, 10, 12, 13, 14, 15, 16, 17, 18, 19, 20, 21, 22, 23, 24, 25, 26, 27, 28, 29, 30, 31, 32, 33, 34, 35, 36, 37, 38, 40, 41, 42, 43, 44, 45, 46, 47, 48, 49, 50, 51, 52, 53, 54, 55, 56, 57, 58, 59, 60, 61, 62, 63, 64, 65, 66, 67, 68, 69, 70, 71, 72, 73, 74, 76, 77, 78, 79, 80, 81, 82, 83, 84, 85, 86, 87, 88, 89, 90, 91, 92, 93, 94, 95, 96, 97, 98, 99, 100, 101, 102, 104, 105, 106, 107, 108, 109, 110, 111, 112, 113, 114, 115, 116, 117, 118, 119, 120, 121, 122 NOTE—Pilot subcarriers ($\pm 103, \pm 75, \pm 39, \pm 11$) and DC subcarriers (0, ± 1) are skipped.
	2	122	-122, -120, -118, -116, -114, -112, -110, -108, -106, -104, -102, -100, -98, -96, -94, -92, -90, -88, -86, -84, -82, -80, -78, -76, -74, -72, -70, -68, -66, -64, -62, -60, -58, -56, -54, -52, -50, -48, -46, -44, -42, -40, -38, -36, -34, -32, -30, -28, -26, -24, -22, -20, -18, -16, -14, -12, -10, -8, -6, -4, -2, 2, 4, 6, 8, 10, 12, 14, 16, 18, 20, 22, 24, 26, 28, 30, 32, 34, 36, 38, 40, 42, 44, 46, 48, 50, 52, 54, 56, 58, 60, 62, 64, 66, 68, 70, 72, 74, 76, 78, 80, 82, 84, 86, 88, 90, 92, 94, 96, 98, 100, 102, 104, 106, 108, 110, 112, 114, 116, 118, 120, 122
	4	62	-122, -118, -114, -110, -106, -102, -98, -94, -90, -86, -82, -78, -74, -70, -66, -62, -58, -54, -50, -46, -42, -38, -34, -30, -26, -22, -18, -14, -10, -6, -2, 2, 6, 10, 14, 18, 22, 26, 30, 34, 38, 42, 46, 50, 54, 58, 62, 66, 70, 74, 78, 82, 86, 90, 94, 98, 102, 106, 110, 114, 118, 122

Table 8-53g—Subcarriers for which a Compressed Beamforming Feedback Matrix subfield is sent back (continued)

Channel Width	N_g	N_s	Subcarriers for which Compressed Feedback Beamforming Matrix subfield is sent: $scidx(0), scidx(1), \dots, scidx(N_s-1)$
160 MHz	1	468	<p>–250, –249, –248, –247, –246, –245, –244, –243, –242, –241, –240, –239, –238, –237, –236, –235, –234, –233, –232, –230, –229, –228, –227, –226, –225, –224, –223, –222, –221, –220, –219, –218, –217, –216, –215, –214, –213, –212, –211, –210, –209, –208, –207, –206, –205, –204, –202, –201, –200, –199, –198, –197, –196, –195, –194, –193, –192, –191, –190, –189, –188, –187, –186, –185, –184, –183, –182, –181, –180, –179, –178, –177, –176, –175, –174, –173, –172, –171, –170, –169, –168, –166, –165, –164, –163, –162, –161, –160, –159, –158, –157, –156, –155, –154, –153, –152, –151, –150, –149, –148, –147, –146, –145, –144, –143, –142, –141, –140, –138, –137, –136, –135, –134, –133, –132, –131, –130, –126, –125, –124, –123, –122, –121, –120, –119, –118, –116, –115, –114, –113, –112, –111, –110, –109, –108, –107, –106, –105, –104, –103, –102, –101, –100, –99, –98, –97, –96, –95, –94, –93, –92, –91, –90, –88, –87, –86, –85, –84, –83, –82, –81, –80, –79, –78, –77, –76, –75, –74, –73, –72, –71, –70, –69, –68, –67, –66, –65, –64, –63, –62, –61, –60, –59, –58, –57, –56, –55, –54, –52, –51, –50, –49, –48, –47, –46, –45, –44, –43, –42, –41, –40, –39, –38, –37, –36, –35, –34, –33, –32, –31, –30, –29, –28, –27, –26, –24, –23, –22, –21, –20, –19, –18, –17, –16, –15, –14, –13, –12, –11, –10, –9, –8, –7, –6, 6, 7, 8, 9, 10, 11, 12, 13, 14, 15, 16, 17, 18, 19, 20, 21, 22, 23, 24, 26, 27, 28, 29, 30, 31, 32, 33, 34, 35, 36, 37, 38, 39, 40, 41, 42, 43, 44, 45, 46, 47, 48, 49, 50, 51, 52, 54, 55, 56, 57, 58, 59, 60, 61, 62, 63, 64, 65, 66, 67, 68, 69, 70, 71, 72, 73, 74, 75, 76, 77, 78, 79, 80, 81, 82, 83, 84, 85, 86, 87, 88, 90, 91, 92, 93, 94, 95, 96, 97, 98, 99, 100, 101, 102, 103, 104, 105, 106, 107, 108, 109, 110, 111, 112, 113, 114, 115, 116, 118, 119, 120, 121, 122, 123, 124, 125, 126, 130, 131, 132, 133, 134, 135, 136, 137, 138, 140, 141, 142, 143, 144, 145, 146, 147, 148, 149, 150, 151, 152, 153, 154, 155, 156, 157, 158, 159, 160, 161, 162, 163, 164, 165, 166, 168, 169, 170, 171, 172, 173, 174, 175, 176, 177, 178, 179, 180, 181, 182, 183, 184, 185, 186, 187, 188, 189, 190, 191, 192, 193, 194, 195, 196, 197, 198, 199, 200, 201, 202, 204, 205, 206, 207, 208, 209, 210, 211, 212, 213, 214, 215, 216, 217, 218, 219, 220, 221, 222, 223, 224, 225, 226, 227, 228, 229, 230, 232, 233, 234, 235, 236, 237, 238, 239, 240, 241, 242, 243, 244, 245, 246, 247, 248, 249, 250</p> <p>NOTE—Pilot subcarriers ($\pm 231, \pm 203, \pm 167, \pm 139, \pm 117, \pm 89, \pm 53, \pm 25$), DC subcarriers (0, $\pm 1, \pm 2, \pm 3, \pm 4, \pm 5$) and subcarriers $\pm 127, \pm 128, \pm 129$ are skipped.</p>
		2	244

Table 8-53g—Subcarriers for which a Compressed Beamforming Feedback Matrix subfield is sent back (continued)

Channel Width	N_g	N_s	Subcarriers for which Compressed Feedback Beamforming Matrix subfield is sent: $scidx(0), scidx(1), \dots, scidx(N_s-1)$
160 MHz	4	124	<p>–250, –246, –242, –238, –234, –230, –226, –222, –218, –214, –210, –206, –202, –198, –194, –190, –186, –182, –178, –174, –170, –166, –162, –158, –154, –150, –146, –142, –138, –134, –130, –126, –122, –118, –114, –110, –106, –102, –98, –94, –90, –86, –82, –78, –74, –70, –66, –62, –58, –54, –50, –46, –42, –38, –34, –30, –26, –22, –18, –14, –10, –6, 6, 10, 14, 18, 22, 26, 30, 34, 38, 42, 46, 50, 54, 58, 62, 66, 70, 74, 78, 82, 86, 90, 94, 98, 102, 106, 110, 114, 118, 122, 126, 130, 134, 138, 142, 146, 150, 154, 158, 162, 166, 170, 174, 178, 182, 186, 190, 194, 198, 202, 206, 210, 214, 218, 222, 226, 230, 234, 238, 242, 246, 250</p> <p>NOTE—DC subcarriers ± 2 are skipped.</p>

IECNORM.COM : Click to view the full PDF of ISO/IEC/IEEE 8802-11:2012/Amd.4:2015

Table 8-53g—Subcarriers for which a Compressed Beamforming Feedback Matrix subfield is sent back (continued)

Channel Width	N_g	N_s	Subcarriers for which Compressed Feedback Beamforming Matrix subfield is sent: $scidx(0), scidx(1), \dots, scidx(N_s-1)$
80+80 MHz	1	468	<p> -122(L), -121(L), -120(L), -119(L), -118(L), -117(L), -116(L), -115(L), -114(L), -113(L), -112(L), -111(L), -110(L), -109(L), -108(L), -107(L), -106(L), -105(L), -104(L), -102(L), -101(L), -100(L), -99(L), -98(L), -97(L), -96(L), -95(L), -94(L), -93(L), -92(L), -91(L), -90(L), -89(L), -88(L), -87(L), -86(L), -85(L), -84(L), -83(L), -82(L), -81(L), -80(L), -79(L), -78(L), -77(L), -76(L), -74(L), -73(L), -72(L), -71(L), -70(L), -69(L), -68(L), -67(L), -66(L), -65(L), -64(L), -63(L), -62(L), -61(L), -60(L), -59(L), -58(L), -57(L), -56(L), -55(L), -54(L), -53(L), -52(L), -51(L), -50(L), -49(L), -48(L), -47(L), -46(L), -45(L), -44(L), -43(L), -42(L), -41(L), -40(L), -38(L), -37(L), -36(L), -35(L), -34(L), -33(L), -32(L), -31(L), -30(L), -29(L), -28(L), -27(L), -26(L), -25(L), -24(L), -23(L), -22(L), -21(L), -20(L), -19(L), -18(L), -17(L), -16(L), -15(L), -14(L), -13(L), -12(L), -10(L), -9(L), -8(L), -7(L), -6(L), -5(L), -4(L), -3(L), -2(L), 2(L), 3(L), 4(L), 5(L), 6(L), 7(L), 8(L), 9(L), 10(L), 12(L), 13(L), 14(L), 15(L), 16(L), 17(L), 18(L), 19(L), 20(L), 21(L), 22(L), 23(L), 24(L), 25(L), 26(L), 27(L), 28(L), 29(L), 30(L), 31(L), 32(L), 33(L), 34(L), 35(L), 36(L), 37(L), 38(L), 40(L), 41(L), 42(L), 43(L), 44(L), 45(L), 46(L), 47(L), 48(L), 49(L), 50(L), 51(L), 52(L), 53(L), 54(L), 55(L), 56(L), 57(L), 58(L), 59(L), 60(L), 61(L), 62(L), 63(L), 64(L), 65(L), 66(L), 67(L), 68(L), 69(L), 70(L), 71(L), 72(L), 73(L), 74(L), 76(L), 77(L), 78(L), 79(L), 80(L), 81(L), 82(L), 83(L), 84(L), 85(L), 86(L), 87(L), 88(L), 89(L), 90(L), 91(L), 92(L), 93(L), 94(L), 95(L), 96(L), 97(L), 98(L), 99(L), 100(L), 101(L), 102(L), 104(L), 105(L), 106(L), 107(L), 108(L), 109(L), 110(L), 111(L), 112(L), 113(L), 114(L), 115(L), 116(L), 117(L), 118(L), 119(L), 120(L), 121(L), 122(L), -122(H), -121(H), -120(H), -119(H), -118(H), -117(H), -116(H), -115(H), -114(H), -113(H), -112(H), -111(H), -110(H), -109(H), -108(H), -107(H), -106(H), -105(H), -104(H), -102(H), -101(H), -100(H), -99(H), -98(H), -97(H), -96(H), -95(H), -94(H), -93(H), -92(H), -91(H), -90(H), -89(H), -88(H), -87(H), -86(H), -85(H), -84(H), -83(H), -82(H), -81(H), -80(H), -79(H), -78(H), -77(H), -76(H), -74(H), -73(H), -72(H), -71(H), -70(H), -69(H), -68(H), -67(H), -66(H), -65(H), -64(H), -63(H), -62(H), -61(H), -60(H), -59(H), -58(H), -57(H), -56(H), -55(H), -54(H), -53(H), -52(H), -51(H), -50(H), -49(H), -48(H), -47(H), -46(H), -45(H), -44(H), -43(H), -42(H), -41(H), -40(H), -38(H), -37(H), -36(H), -35(H), -34(H), -33(H), -32(H), -31(H), -30(H), -29(H), -28(H), -27(H), -26(H), -25(H), -24(H), -23(H), -22(H), -21(H), -20(H), -19(H), -18(H), -17(H), -16(H), -15(H), -14(H), -13(H), -12(H), -10(H), -9(H), -8(H), -7(H), -6(H), -5(H), -4(H), -3(H), -2(H), 2(H), 3(H), 4(H), 5(H), 6(H), 7(H), 8(H), 9(H), 10(H), 12(H), 13(H), 14(H), 15(H), 16(H), 17(H), 18(H), 19(H), 20(H), 21(H), 22(H), 23(H), 24(H), 25(H), 26(H), 27(H), 28(H), 29(H), 30(H), 31(H), 32(H), 33(H), 34(H), 35(H), 36(H), 37(H), 38(H), 40(H), 41(H), 42(H), 43(H), 44(H), 45(H), 46(H), 47(H), 48(H), 49(H), 50(H), 51(H), 52(H), 53(H), 54(H), 55(H), 56(H), 57(H), 58(H), 59(H), 60(H), 61(H), 62(H), 63(H), 64(H), 65(H), 66(H), 67(H), 68(H), 69(H), 70(H), 71(H), 72(H), 73(H), 74(H), 76(H), 77(H), 78(H), 79(H), 80(H), 81(H), 82(H), 83(H), 84(H), 85(H), 86(H), 87(H), 88(H), 89(H), 90(H), 91(H), 92(H), 93(H), 94(H), 95(H), 96(H), 97(H), 98(H), 99(H), 100(H), 101(H), 102(H), 104(H), 105(H), 106(H), 107(H), 108(H), 109(H), 110(H), 111(H), 112(H), 113(H), 114(H), 115(H), 116(H), 117(H), 118(H), 119(H), 120(H), 121(H), 122(H) </p> <p>NOTE 1—Subcarrier $x(L)$ denotes subcarrier index x in the frequency segment lower in frequency, and subcarrier $x(H)$ denotes subcarrier index x in the frequency segment higher in frequency.</p> <p>NOTE 2—Pilot subcarriers ($\pm 103, \pm 75, \pm 39, \pm 11$) and DC subcarriers (0, ± 1) are skipped in each frequency segment.</p>

Table 8-53g—Subcarriers for which a Compressed Beamforming Feedback Matrix subfield is sent back (continued)

Channel Width	N_g	N_s	Subcarriers for which Compressed Feedback Beamforming Matrix subfield is sent: $scidx(0), scidx(1), \dots, scidx(N_s-1)$
80+80 MHz	2	244	-122(L), -120(L), -118(L), -116(L), -114(L), -112(L), -110(L), -108(L), -106(L), -104(L), -102(L), -100(L), -98(L), -96(L), -94(L), -92(L), -90(L), -88(L), -86(L), -84(L), -82(L), -80(L), -78(L), -76(L), -74(L), -72(L), -70(L), -68(L), -66(L), -64(L), -62(L), -60(L), -58(L), -56(L), -54(L), -52(L), -50(L), -48(L), -46(L), -44(L), -42(L), -40(L), -38(L), -36(L), -34(L), -32(L), -30(L), -28(L), -26(L), -24(L), -22(L), -20(L), -18(L), -16(L), -14(L), -12(L), -10(L), -8(L), -6(L), -4(L), -2(L), 2(L), 4(L), 6(L), 8(L), 10(L), 12(L), 14(L), 16(L), 18(L), 20(L), 22(L), 24(L), 26(L), 28(L), 30(L), 32(L), 34(L), 36(L), 38(L), 40(L), 42(L), 44(L), 46(L), 48(L), 50(L), 52(L), 54(L), 56(L), 58(L), 60(L), 62(L), 64(L), 66(L), 68(L), 70(L), 72(L), 74(L), 76(L), 78(L), 80(L), 82(L), 84(L), 86(L), 88(L), 90(L), 92(L), 94(L), 96(L), 98(L), 100(L), 102(L), 104(L), 106(L), 108(L), 110(L), 112(L), 114(L), 116(L), 118(L), 120(L), 122(L), -122(H), -120(H), -118(H), -116(H), -114(H), -112(H), -110(H), -108(H), -106(H), -104(H), -102(H), -100(H), -98(H), -96(H), -94(H), -92(H), -90(H), -88(H), -86(H), -84(H), -82(H), -80(H), -78(H), -76(H), -74(H), -72(H), -70(H), -68(H), -66(H), -64(H), -62(H), -60(H), -58(H), -56(H), -54(H), -52(H), -50(H), -48(H), -46(H), -44(H), -42(H), -40(H), -38(H), -36(H), -34(H), -32(H), -30(H), -28(H), -26(H), -24(H), -22(H), -20(H), -18(H), -16(H), -14(H), -12(H), -10(H), -8(H), -6(H), -4(H), -2(H), 2(H), 4(H), 6(H), 8(H), 10(H), 12(H), 14(H), 16(H), 18(H), 20(H), 22(H), 24(H), 26(H), 28(H), 30(H), 32(H), 34(H), 36(H), 38(H), 40(H), 42(H), 44(H), 46(H), 48(H), 50(H), 52(H), 54(H), 56(H), 58(H), 60(H), 62(H), 64(H), 66(H), 68(H), 70(H), 72(H), 74(H), 76(H), 78(H), 80(H), 82(H), 84(H), 86(H), 88(H), 90(H), 92(H), 94(H), 96(H), 98(H), 100(H), 102(H), 104(H), 106(H), 108(H), 110(H), 112(H), 114(H), 116(H), 118(H), 120(H), 122(H)
	4	124	-122(L), -118(L), -114(L), -110(L), -106(L), -102(L), -98(L), -94(L), -90(L), -86(L), -82(L), -78(L), -74(L), -70(L), -66(L), -62(L), -58(L), -54(L), -50(L), -46(L), -42(L), -38(L), -34(L), -30(L), -26(L), -22(L), -18(L), -14(L), -10(L), -6(L), -2(L), 2(L), 6(L), 10(L), 14(L), 18(L), 22(L), 26(L), 30(L), 34(L), 38(L), 42(L), 46(L), 50(L), 54(L), 58(L), 62(L), 66(L), 70(L), 74(L), 78(L), 82(L), 86(L), 90(L), 94(L), 98(L), 102(L), 106(L), 110(L), 114(L), 118(L), 122(L), -122(H), -118(H), -114(H), -110(H), -106(H), -102(H), -98(H), -94(H), -90(H), -86(H), -82(H), -78(H), -74(H), -70(H), -66(H), -62(H), -58(H), -54(H), -50(H), -46(H), -42(H), -38(H), -34(H), -30(H), -26(H), -22(H), -18(H), -14(H), -10(H), -6(H), -2(H), 2(H), 6(H), 10(H), 14(H), 18(H), 22(H), 26(H), 30(H), 34(H), 38(H), 42(H), 46(H), 50(H), 54(H), 58(H), 62(H), 66(H), 70(H), 74(H), 78(H), 82(H), 86(H), 90(H), 94(H), 98(H), 102(H), 106(H), 110(H), 114(H), 118(H), 122(H)

IECNORM.COM : Click to visit http://www.iec-norm.com/ ISO/IEC/IEEE 8802-11:2012/Amd.4:2015

The Average SNR of Space-Time Stream i subfield in the Table 8-53f is an 8-bit two's complement integer whose definition is shown in Table 8-53h.

Table 8-53h—Average SNR of Space-Time Stream i subfield

Average SNR of Space-Time Stream i subfield	$AvgSNR_i$
−128	≤ −10 dB
−127	−9.75 dB
−126	−9.5 dB
...	...
+126	53.5 dB
+127	≥ 53.75 dB

The $AvgSNR_i$ in Table 8-53h is found by computing the SNR per subcarrier in decibels for the subcarriers identified in Table 8-53g, and then computing the arithmetic mean of those values. Each SNR value per tone in stream i (before being averaged) corresponds to the SNR associated with the column i of the beamforming feedback matrix V determined at the beamformee. Each SNR corresponds to the predicted SNR at the beamformee when the beamformer applies all columns of the matrix V .

A STA with a 40 MHz, 80 MHz, or 160 MHz operating channel width and sending feedback for a 20 MHz channel width includes only subcarriers corresponding to the primary 20 MHz channel in the Compressed Feedback Beamforming Matrix subfield.

A STA with an 80 MHz or 160 MHz operating channel width and sending feedback for a 40 MHz channel width includes only subcarriers corresponding to the primary 40 MHz channel in the Compressed Feedback Beamforming Matrix subfield.

A STA with a 160 MHz or 80+80 MHz operating channel width and sending feedback for an 80 MHz channel width includes only subcarriers corresponding to the primary 80 MHz channel in the Compressed Feedback Beamforming Matrix subfield.

NOTE—Multi-bit fields are transmitted LSB first according to the bit-ordering specification detailed in 8.2.2.

8.4.1.49 MU Exclusive Beamforming Report field

The MU Exclusive Beamforming Report field is used by the VHT Compressed Beamforming feedback (see 8.5.23.2) to carry explicit feedback information in the form of delta SNRs. The information in the VHT Compressed Beamforming Report field and the MU Exclusive Beamforming Report field can be used by the transmit MU beamformer to determine steering matrices Q , as described in 9.29.3, 20.3.12.3, and Table 22.3.11.

The size of the MU Exclusive Beamforming Report field depends on the values in the VHT MIMO Control field. The MU Exclusive Beamforming Report field contains MU Exclusive Beamforming Report information or successive (possibly zero-length) portions thereof in the case of segmented VHT Compressed Beamforming feedback (see 9.31.5). The MU Exclusive Beamforming Report information is included in the VHT Compressed Beamforming feedback if the Feedback Type subfield in the VHT MIMO Control field indicates MU (see 8.4.1.47).

The MU Exclusive Beamforming Report information consists of Delta SNR subfields for each space-time stream (1 to N_c) of a subset of the subcarriers typically spaced $2Ng$ apart, where Ng is signaled in the Grouping subfield of the VHT MIMO Control field, starting from the lowest frequency subcarrier and continuing to the highest frequency subcarrier. No padding is present between $\Delta SNR_{k,i}$ in the MU Exclusive Beamforming Report field, even if they correspond to different subcarriers. The subset of subcarriers included is determined by the values of the Channel Width and Grouping subfields of the VHT MIMO Control field as listed in Table 8-53j. For each subcarrier included, the deviation in dB of the SNR of that subcarrier for each column of V relative to the average SNR of the corresponding space-time stream is computed using Equation (8-2).

$$\Delta SNR_{k,i} = \min(\max(\text{round}(10\log_{10}\left(\frac{\|H_k V_{k,i}\|^2}{N}\right) - \overline{SNR}_i), -8), 7) \tag{8-2}$$

where

- k is the subcarrier index in the range of $sscidx(0), \dots, scidx(Ns'-1)$
- i is the space-time stream index in the range of $1, \dots, N_c$
- H_k is the estimated MIMO channel for subcarrier k
- $V_{k,i}$ is column i of the beamforming matrix V for subcarrier k
- N is the average noise plus interference power, measured at the beamformee, that was used to calculate \overline{SNR}_i
- \overline{SNR}_i is the average SNR of space-time stream i reported in the VHT Compressed Beamforming Report information (Average SNR in Space-Time Stream i field)

Each Delta SNR subfield contains the $\Delta SNR_{k,i}$ computed using Equation (8-2) and quantized to 4 bits in the range -8 dB to 7 dB with 1 dB granularity. The structure of the MU Exclusive Beamforming Report field is shown in Table 8-53i.

Table 8-53i—MU Exclusive Beamforming Report information

Field	Size (Bits)	Meaning
Delta SNR for space-time stream 1 for subcarrier $k = scidx(0)$	4	$\Delta SNR_{sscidx(0),1}$ as defined in Equation (8-2)
...
Delta SNR for space-time stream N_c for subcarrier $k = scidx(0)$	4	$\Delta SNR_{sscidx(0),N_c}$ as defined in Equation (8-2)
Delta SNR for space-time stream 1 for subcarrier $k = scidx(1)$	4	$\Delta SNR_{sscidx(1),1}$ as defined in Equation (8-2)
...
Delta SNR for space-time stream N_c for subcarrier $k = scidx(1)$	4	$\Delta SNR_{sscidx(1),N_c}$ as defined in Equation (8-2)
...

Table 8-53i—MU Exclusive Beamforming Report information (continued)

Field	Size (Bits)	Meaning
Delta SNR for space-time stream 1 for subcarrier $k = sscidx(Ns' - 1)$	4	$\Delta SNR_{sscidx(Ns' - 1), 1}$ as defined in Equation (8-2)
...
Delta SNR for space-time stream N_c for subcarrier $k = sscidx(Ns' - 1)$	4	$\Delta SNR_{sscidx(Ns' - 1), N_c}$ as defined in Equation (8-2)
NOTE— $sscidx()$ is defined in Table 8-53j.		

In Table 8-53i, Ns' is the number of subcarriers for which the Delta SNR subfield is sent back to the beamformer. Table 8-53j shows Ns' , the exact subcarrier indices and their order for which the Delta SNR is sent back.

Table 8-53j—Number of subcarriers and subcarrier mapping

Channel Width	N_g	Ns'	Subcarriers for which the Delta SNR subfield is sent: $sscidx(0), sscidx(1), \dots, sscidx(Ns' - 1)$
20 MHz	1	30	-28, -26, -24, -22, -20, -18, -16, -14, -12, -10, -8, -6, -4, -2, -1, 1, 2, 4, 6, 8, 10, 12, 14, 16, 18, 20, 22, 24, 26, 28
	2	16	-28, -24, -20, -16, -12, -8, -4, -1, 1, 4, 8, 12, 16, 20, 24, 28
	4	10	-28, -20, -12, -4, -1, 1, 4, 12, 20, 28
40 MHz	1	58	-58, -56, -54, -52, -50, -48, -46, -44, -42, -40, -38, -36, -34, -32, -30, -28, -26, -24, -22, -20, -18, -16, -14, -12, -10, -8, -6, -4, -2, 2, 4, 6, 8, 10, 12, 14, 16, 18, 20, 22, 24, 26, 28, 30, 32, 34, 36, 38, 40, 42, 44, 46, 48, 50, 52, 54, 56, 58
	2	30	-58, -54, -50, -46, -42, -38, -34, -30, -26, -22, -18, -14, -10, -6, -2, 2, 6, 10, 14, 18, 22, 26, 30, 34, 38, 42, 46, 50, 54, 58
	4	16	-58, -50, -42, -34, -26, -18, -10, -2, 2, 10, 18, 26, 34, 42, 50, 58
80 MHz	1	122	-122, -120, -118, -116, -114, -112, -110, -108, -106, -104, -102, -100, -98, -96, -94, -92, -90, -88, -86, -84, -82, -80, -78, -76, -74, -72, -70, -68, -66, -64, -62, -60, -58, -56, -54, -52, -50, -48, -46, -44, -42, -40, -38, -36, -34, -32, -30, -28, -26, -24, -22, -20, -18, -16, -14, -12, -10, -8, -6, -4, -2, 2, 4, 6, 8, 10, 12, 14, 16, 18, 20, 22, 24, 26, 28, 30, 32, 34, 36, 38, 40, 42, 44, 46, 48, 50, 52, 54, 56, 58, 60, 62, 64, 66, 68, 70, 72, 74, 76, 78, 80, 82, 84, 86, 88, 90, 92, 94, 96, 98, 100, 102, 104, 106, 108, 110, 112, 114, 116, 118, 120, 122
	2	62	-122, -118, -114, -110, -106, -102, -98, -94, -90, -86, -82, -78, -74, -70, -66, -62, -58, -54, -50, -46, -42, -38, -34, -30, -26, -22, -18, -14, -10, -6, -2, 2, 6, 10, 14, 18, 22, 26, 30, 34, 38, 42, 46, 50, 54, 58, 62, 66, 70, 74, 78, 82, 86, 90, 94, 98, 102, 106, 110, 114, 118, 122
	4	32	-122, -114, -106, -98, -90, -82, -74, -66, -58, -50, -42, -34, -26, -18, -10, -2, 2, 10, 18, 26, 34, 42, 50, 58, 66, 74, 82, 90, 98, 106, 114, 122

Table 8-53j—Number of subcarriers and subcarrier mapping (continued)

Channel Width	N_g	N_s'	Subcarriers for which the Delta SNR subfield is sent: $sscidx(0)$, $sscidx(1)$, ... $sscidx(N_s'-1)$
160 MHz	1	244	-250, -248, -246, -244, -242, -240, -238, -236, -234, -232, -230, -228, -226, -224, -222, -220, -218, -216, -214, -212, -210, -208, -206, -204, -202, -200, -198, -196, -194, -192, -190, -188, -186, -184, -182, -180, -178, -176, -174, -172, -170, -168, -166, -164, -162, -160, -158, -156, -154, -152, -150, -148, -146, -144, -142, -140, -138, -136, -134, -132, -130, -126, -124, -122, -120, -118, -116, -114, -112, -110, -108, -106, -104, -102, -100, -98, -96, -94, -92, -90, -88, -86, -84, -82, -80, -78, -76, -74, -72, -70, -68, -66, -64, -62, -60, -58, -56, -54, -52, -50, -48, -46, -44, -42, -40, -38, -36, -34, -32, -30, -28, -26, -24, -22, -20, -18, -16, -14, -12, -10, -8, -6, 6, 8, 10, 12, 14, 16, 18, 20, 22, 24, 26, 28, 30, 32, 34, 36, 38, 40, 42, 44, 46, 48, 50, 52, 54, 56, 58, 60, 62, 64, 66, 68, 70, 72, 74, 76, 78, 80, 82, 84, 86, 88, 90, 92, 94, 96, 98, 100, 102, 104, 106, 108, 110, 112, 114, 116, 118, 120, 122, 124, 126, 130, 132, 134, 136, 138, 140, 142, 144, 146, 148, 150, 152, 154, 156, 158, 160, 162, 164, 166, 168, 170, 172, 174, 176, 178, 180, 182, 184, 186, 188, 190, 192, 194, 196, 198, 200, 202, 204, 206, 208, 210, 212, 214, 216, 218, 220, 222, 224, 226, 228, 230, 232, 234, 236, 238, 240, 242, 244, 246, 248, 250 NOTE—Subcarriers 0, ± 2 , ± 4 and ± 128 are skipped.
	2	124	-250, -246, -242, -238, -234, -230, -226, -222, -218, -214, -210, -206, -202, -198, -194, -190, -186, -182, -178, -174, -170, -166, -162, -158, -154, -150, -146, -142, -138, -134, -130, -126, -122, -118, -114, -110, -106, -102, -98, -94, -90, -86, -82, -78, -74, -70, -66, -62, -58, -54, -50, -46, -42, -38, -34, -30, -26, -22, -18, -14, -10, -6, 6, 10, 14, 18, 22, 26, 30, 34, 38, 42, 46, 50, 54, 58, 62, 66, 70, 74, 78, 82, 86, 90, 94, 98, 102, 106, 110, 114, 118, 122, 126, 130, 134, 138, 142, 146, 150, 154, 158, 162, 166, 170, 174, 178, 182, 186, 190, 194, 198, 202, 206, 210, 214, 218, 222, 226, 230, 234, 238, 242, 246, 250 NOTE—Subcarriers ± 2 are skipped.
	4	64	-250, -242, -234, -226, -218, -210, -202, -194, -186, -178, -170, -162, -154, -146, -138, -130, -126, -118, -110, -102, -94, -86, -78, -70, -62, -54, -46, -38, -30, -22, -14, -6, 6, 14, 22, 30, 38, 46, 54, 62, 70, 78, 86, 94, 102, 110, 118, 126, 130, 138, 146, 154, 162, 170, 178, 186, 194, 202, 210, 218, 226, 234, 242, 250

IECNORM.COM : Click to view the PDF of ISO/IEC/IEEE 8802-11:2012/Amd.4:2015

Table 8-53j—Number of subcarriers and subcarrier mapping (continued)

Channel Width	N_g	N_s'	Subcarriers for which the Delta SNR subfield is sent: $sscid_x(0)$, $sscid_x(1)$, ... $sscid_x(N_s'-1)$
80+80 MHz	1	244	-122(L), -120(L), -118(L), -116(L), -114(L), -112(L), -110(L), -108(L), -106(L), -104(L), -102(L), -100(L), -98(L), -96(L), -94(L), -92(L), -90(L), -88(L), -86(L), -84(L), -82(L), -80(L), -78(L), -76(L), -74(L), -72(L), -70(L), -68(L), -66(L), -64(L), -62(L), -60(L), -58(L), -56(L), -54(L), -52(L), -50(L), -48(L), -46(L), -44(L), -42(L), -40(L), -38(L), -36(L), -34(L), -32(L), -30(L), -28(L), -26(L), -24(L), -22(L), -20(L), -18(L), -16(L), -14(L), -12(L), -10(L), -8(L), -6(L), -4(L), -2(L), 2(L), 4(L), 6(L), 8(L), 10(L), 12(L), 14(L), 16(L), 18(L), 20(L), 22(L), 24(L), 26(L), 28(L), 30(L), 32(L), 34(L), 36(L), 38(L), 40(L), 42(L), 44(L), 46(L), 48(L), 50(L), 52(L), 54(L), 56(L), 58(L), 60(L), 62(L), 64(L), 66(L), 68(L), 70(L), 72(L), 74(L), 76(L), 78(L), 80(L), 82(L), 84(L), 86(L), 88(L), 90(L), 92(L), 94(L), 96(L), 98(L), 100(L), 102(L), 104(L), 106(L), 108(L), 110(L), 112(L), 114(L), 116(L), 118(L), 120(L), 122(L), -122(H), -120(H), -118(H), -116(H), -114(H), -112(H), -110(H), -108(H), -106(H), -104(H), -102(H), -100(H), -98(H), -96(H), -94(H), -92(H), -90(H), -88(H), -86(H), -84(H), -82(H), -80(H), -78(H), -76(H), -74(H), -72(H), -70(H), -68(H), -66(H), -64(H), -62(H), -60(H), -58(H), -56(H), -54(H), -52(H), -50(H), -48(H), -46(H), -44(H), -42(H), -40(H), -38(H), -36(H), -34(H), -32(H), -30(H), -28(H), -26(H), -24(H), -22(H), -20(H), -18(H), -16(H), -14(H), -12(H), -10(H), -8(H), -6(H), -4(H), -2(H), 2(H), 4(H), 6(H), 8(H), 10(H), 12(H), 14(H), 16(H), 18(H), 20(H), 22(H), 24(H), 26(H), 28(H), 30(H), 32(H), 34(H), 36(H), 38(H), 40(H), 42(H), 44(H), 46(H), 48(H), 50(H), 52(H), 54(H), 56(H), 58(H), 60(H), 62(H), 64(H), 66(H), 68(H), 70(H), 72(H), 74(H), 76(H), 78(H), 80(H), 82(H), 84(H), 86(H), 88(H), 90(H), 92(H), 94(H), 96(H), 98(H), 100(H), 102(H), 104(H), 106(H), 108(H), 110(H), 112(H), 114(H), 116(H), 118(H), 120(H), 122(H)
	2	124	-122(L), -118(L), -114(L), -110(L), -106(L), -102(L), -98(L), -94(L), -90(L), -86(L), -82(L), -78(L), -74(L), -70(L), -66(L), -62(L), -58(L), -54(L), -50(L), -46(L), -42(L), -38(L), -34(L), -30(L), -26(L), -22(L), -18(L), -14(L), -10(L), -6(L), -2(L), 2(L), 6(L), 10(L), 14(L), 18(L), 22(L), 26(L), 30(L), 34(L), 38(L), 42(L), 46(L), 50(L), 54(L), 58(L), 62(L), 66(L), 70(L), 74(L), 78(L), 82(L), 86(L), 90(L), 94(L), 98(L), 102(L), 106(L), 110(L), 114(L), 118(L), 122(L), -122(H), -118(H), -114(H), -110(H), -106(H), -102(H), -98(H), -94(H), -90(H), -86(H), -82(H), -78(H), -74(H), -70(H), -66(H), -62(H), -58(H), -54(H), -50(H), -46(H), -42(H), -38(H), -34(H), -30(H), -26(H), -22(H), -18(H), -14(H), -10(H), -6(H), -2(H), 2(H), 6(H), 10(H), 14(H), 18(H), 22(H), 26(H), 30(H), 34(H), 38(H), 42(H), 46(H), 50(H), 54(H), 58(H), 62(H), 66(H), 70(H), 74(H), 78(H), 82(H), 86(H), 90(H), 94(H), 98(H), 102(H), 106(H), 110(H), 114(H), 118(H), 122(H)
	4	64	-122(L), -114(L), -106(L), -98(L), -90(L), -82(L), -74(L), -66(L), -58(L), -50(L), -42(L), -34(L), -26(L), -18(L), -10(L), -2(L), 2(L), 10(L), 18(L), 26(L), 34(L), 42(L), 50(L), 58(L), 66(L), 74(L), 82(L), 90(L), 98(L), 106(L), 114(L), 122(L), - 122(H), -114(H), -106(H), -98(H), -90(H), -82(H), -74(H), -66(H), -58(H), - 50(H), -42(H), -34(H), -26(H), -18(H), -10(H), -2(H), 2(H), 10(H), 18(H), 26(H), 34(H), 42(H), 50(H), 58(H), 66(H), 74(H), 82(H), 90(H), 98(H), 106(H), 114(H), 122(H)

NOTE 1— $sscid_x()$ is defined in Table 8-53i.

NOTE 2—Subcarrier $x(L)$ denotes subcarrier index x in the frequency segment lower in frequency, and subcarrier $x(H)$ denotes subcarrier index x in the frequency segment higher in frequency.

8.4.1.50 Operating Mode field

The Operating Mode field is present in the Operating Mode Notification frame (see 8.5.23.4) and Operating Mode Notification element (see 8.4.2.168).

The Operating Mode field is shown in Figure 8-80e.

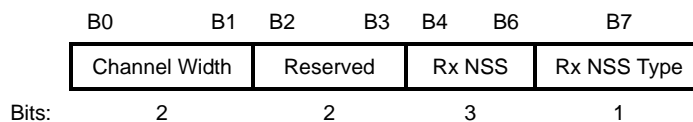

Figure 8-80e—Operating Mode field

The STA transmitting this field indicates its current operating channel width and the number of spatial streams it can receive using the settings defined in Table 8-53k.

Table 8-53k—Subfield values of the Operating Mode field

Subfield	Description
Channel Width	<p>If the Rx NSS Type subfield is 0, indicates the supported channel width: Set to 0 for 20 MHz Set to 1 for 40 MHz Set to 2 for 80 MHz Set to 3 for 160 MHz or 80+80 MHz</p> <p>Reserved if the Rx NSS Type subfield is 1.</p>
Rx NSS	<p>If the Rx NSS Type subfield is 0, indicates the maximum number of spatial streams that the STA can receive.</p> <p>If the Rx NSS Type subfield is 1, indicates the maximum number of spatial streams that the STA can receive as a beamformee in an SU PPDU using a beamforming steering matrix derived from a VHT Compressed Beamforming report with Feedback Type subfield indicating MU in the corresponding VHT Compressed Beamforming frame sent by the STA.</p> <p>Set to 0 for $N_{SS} = 1$ Set to 1 for $N_{SS} = 2$... Set to 7 for $N_{SS} = 8$</p>
Rx NSS Type	<p>Set to 0 to indicate that the Rx NSS subfield carries the maximum number of spatial streams that the STA can receive.</p> <p>Set to 1 to indicate that the Rx NSS subfield carries the maximum number of spatial streams that the STA can receive in an SU PPDU using a beamforming steering matrix derived from a VHT Compressed Beamforming report with the Feedback Type subfield indicating MU in the corresponding VHT Compressed Beamforming frame sent by the STA.</p> <p>NOTE—An AP always sets this field to 0.</p>

8.4.1.51 Membership Status Array field

The Membership Status Array field is used in the Group ID Management frame (see 8.5.23.3). The length of the field is 8 octets. An 8 octet Membership Status Array field (indexed by the group ID) consists of a 1-bit Membership Status subfield for each of the 64 group IDs, as shown in Figure 8-80f.

8.4.2 Information elements

8.4.2.1 General

Insert the following rows into Table 8-54 in numeric order, and change the reserved values accordingly:

Table 8-54—Element IDs

Element	Element ID	Length of indicated element (in octets)	Extensible
VHT Capabilities (see 8.4.2.160)	191	14	Yes
VHT Operation (see 8.4.2.161)	192	7	Yes
Extended BSS Load (see 8.4.2.162)	193	8	Yes
Wide Bandwidth Channel Switch (see 8.4.2.163)	194	5	Yes
VHT Transmit Power Envelope (see 8.4.2.164)	195	5 or 7	Yes
Channel Switch Wrapper (see 8.4.2.165)	196	7 to 257	Subelements
AID (see 8.4.2.166)	197	4	
Quiet Channel	198	3 or 9	Yes
Operating Mode Notification	199	3	Yes

8.4.2.3 Supported Rates element

Change Table 8-55 as follows:

Table 8-55—BSS membership selector value encoding

Value	Feature	Interpretation
127	HT PHY	Support for the mandatory features of Clause 20 is required in order to join the BSS that was the source of the Supported Rates element or Extended Supported Rates element containing this value.
126	VHT PHY	<u>Support for the mandatory features of Clause 22 is required in order to join the BSS that was the source of the Supported Rates element or Extended Supported Rates element containing this value.</u>

8.4.2.10 Country element

Change 8.4.2.10 (including inserting Figure 8-90a to Figure 8-90d) as follows:

The Country element contains the information required to allow a STA to identify the regulatory domain in which the STA is located and to configure its PHY for operation in that regulatory domain. The format of this element is as shown in Figure 8-90.

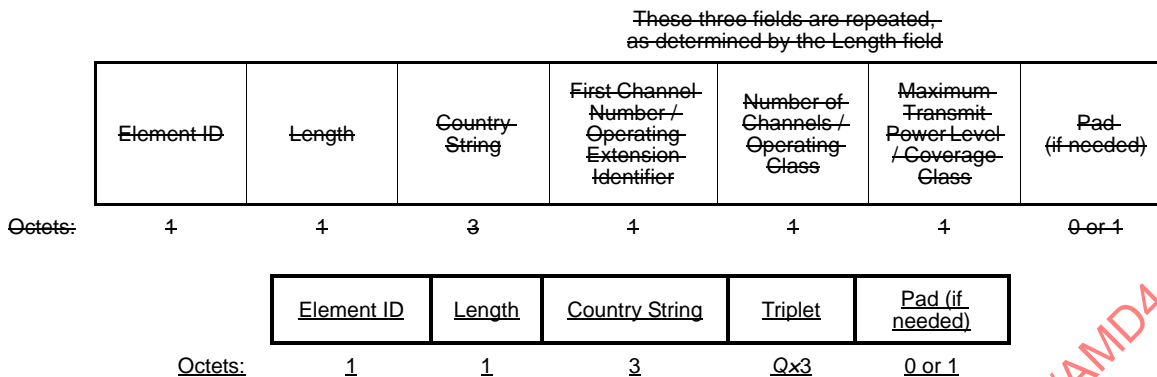
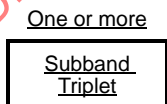

Figure 8-90—Country element format

The element ID for this element is set to the value for Country, specified in Table 8-54. The length of the element is variable, as the element ~~may contains the variable-length Triplet field, more than one triplet comprising the First Channel Number, Number of Channels, and Maximum Transmit Power Level fields and referred to as subband triplets. Alternatively, where dot11OperatingClassesRequired is true and the First Channel Number/Operating Extension Identifier octet has a positive integer value of 201 or greater, then that triplet comprises the Operating Extension Identifier, Operating Class, and Coverage Class fields. Together they are referred to as an operating triplet. The minimum length of the element is 8 octets.~~

If dot11OperatingClassesRequired is false, then the Triplet field is a single Subband Triplet Sequence field, as shown in Figure 8-90a, that is composed of Q Subband Triplet fields, where Q is one or more. The format of the Subband Triplet field is shown in Figure 8-90b.



Octets: 3

Figure 8-90a—Subband Triplet Sequence format

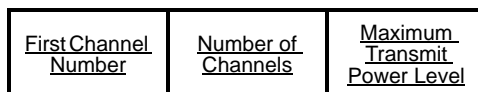

Octets: 1 1 1

Figure 8-90b—Subband Triplet field

If dot11OperatingClassesRequired is true, then the Triplet field is composed of zero or more Subband Triplet fields followed by one or more Operating/Subband Sequences, as shown in Figure 8-90c. Each Operating/Subband Sequence is composed of one Operating Triplet field followed by one Subband Triplet Sequence field, as shown in Figure 8-90d. Each Subband Triplet Sequence field is composed of zero or more Subband Triplet fields. If dot11OperatingClassesRequired is true, the number of triplets in the Triplet

field is $Q = N + \sum_{m=1}^M (1 + P(m))$, where N is the total number of Subband Triplet fields and M is the total

number of Operating/Subband Sequences contained in Country element and $P(m)$ is the number of Subband Triplet fields making up Operating/Subband Sequence field m .

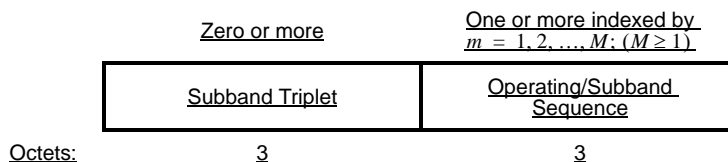

Figure 8-90c—Triplet field if dot11OperatingClassRequired is true

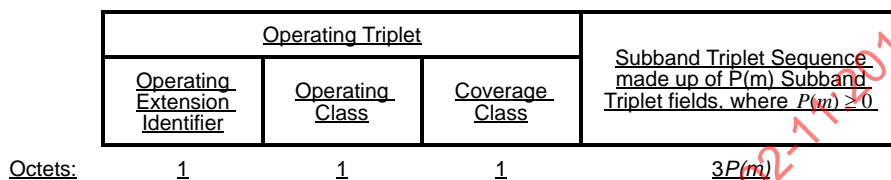

Figure 8-90d—Format of m -th Operating/Subband Sequence field

The number Q of Subband fields or Operating triplet fields in the element is determined by the Length field.

An operating class for an 80+80 MHz channel width is expressed by two consecutive Operating/Subband Sequences, where the first Operating/Subband Sequence field contains an Operating Triplet field indicating an 80 MHz Channel Spacing with an 80+ Behavior Limit and the second Operating/Subband Sequence field contains an Operating Triplet field indicating an 80 MHz Channel Spacing without an 80+ Behavior Limit.

Operating/Subband Sequence fields that contain an Operating Class field for which the “Channel Spacing (MHz)” column in the appropriate table in Annex E equals 80 or 160 contain zero Subband Triplet fields.

NOTE 1—Any Operating Triplet field indicating 80 MHz, 160 MHz, and 80+80 MHz can be omitted from the Country element (see 9.18.5).

NOTE 2—The VHT Transmit Power Envelope element is always used for TPC for 80 MHz, 160 MHz, or 80+80 MHz operating classes instead of Subband Triplet fields (see 10.39.1).

The first octet in each Subband Triplet field or Operating Triplet field contains an unsigned integer and identifies the type of field. If the integer has a value less than or equal to 200, then the field is a Subband Triplet field. If the integer has a value of 201 or greater, then the field is an Operating Triplet field.

The minimum length of the element is 8 octets.

The Country String field of the element is 3 octets in length. The AP and mesh STA set this field to the value contained in the dot11CountryString attribute before transmission in a Beacon or Probe Response frame. Upon reception of this element, a STA sets the value of the dot11CountryString to the value contained in this field. The three octets of the Country String have additional structure as defined by dot11CountryString (see Annex C).

The First Channel Number/Operating Extension Identifier field is 1 octet in length. If the field has a positive integer value less than 201, then it contains a positive integer value that indicates the lowest channel number in the Subband Triplet field subband described in this element. The group of channels described by each pair of the No channel is indicated by more than one pair of First Channel Number and the Number of Channels fields within a Subband Triplet Sequence field do not have overlapping channel identifiers. [For

example, the (First Channel Number, Number of Channels) pairs (2, 4) and (5, 2) in 2.4 GHz each indicate channel 5 overlap and, therefore, are not used within the same Subband Triplet Sequence field together.] The First Channel Numbers are monotonically increasing within a Subband Triplet Sequence field where dot11OperatingClassesRequired is not true.

Where dot11OperatingClassesRequired is true, consecutive subband triplets following an operating triplet have monotonically increasing First Channel Number fields.

The Number of Channels subfield of the subelement is 1 octet in length. Outside the 2.4 GHz band, the channel numbers that are included in a group of channels are separated by the operating channel width. For Subband Triplet fields that are not within an Operating/Subband Sequence field, the operating channel width is 20 MHz. For Subband Triplet fields that are within an Operating/Subband Sequence field, the operating channel width is as indicated by the operating class in the same Operating/Subband Sequence field. In the 2.4 GHz band, the channel numbers that are included in a group of channels are separated by 5 MHz (for both 20 and 40 MHz operating channel width), except that channel 14 is treated as if it were 5 MHz above channel 13.

NOTE—For example, the channels 1 to 11 in the 2.4 GHz band can be represented using one Subband Triplet subfield with First Channel Number = 1 and Number of Channels = 11. The channels 36, 40, 44 and 48 with 20 MHz operating channel width in the 5 GHz band can be represented using one Subband Triplet subfield with First Channel Number = 36 and Number of Channels = 4. The six channels 183, 184, 185, 187, 188 and 189 (but not 186) with 10 MHz operating channel width can be represented using three Subband Triplet subfields: one with First Channel Number = 183 and Number of Channels = 4, one with First Channel Number = 184 and Number of Channels = 1 and one with First Channel Number = 188 and Number of Channels = 1.

The Maximum Transmit Power Level field is a signed number and is 1 octet in length. ~~The Maximum Transmit Power Level field~~ indicates the maximum power, in dBm, allowed to be transmitted. As the method of measurement for maximum transmit power level differs by regulatory domain, the value in this field is interpreted according to the regulations applicable for the domain identified by the Country String.

An operating class is an index into a set of values for radio equipment sets of rules. The Operating Class field is 1 octet in length.

A coverage class is an index into a set of values for aAirPropagationTime. The Coverage Class field is 1 octet in length.

The Coverage Class field of the ~~operating triplet~~ Operating Triplet field specifies the aAirPropagationTime characteristic used in BSS operation, as shown in Table 8-56. The characteristic aAirPropagationTime describes variations in actual propagation time that are accounted for in a BSS and, together with maximum transmit power level, allow control of BSS diameter.

The Pad field is 0 or 1 octet in length. The length of the Country element is evenly divisible by 2. The Pad is used to add a single octet to the element if the length is not evenly divisible by 2. The value of the Pad field is 0.

8.4.2.17 Power Capability element

Change the third and fourth paragraphs in 8.4.2.17 as follows:

The Minimum Transmit Power Capability field is set to the nominal minimum transmit power with which the STA is capable of transmitting in the current channel, with a tolerance ± 5 dB. The field is coded as a signed integer in units of decibels relative to 1 mW. Further interpretation of this field is defined in 10.8.3.

The Maximum Transmit Power Capability field is set to the nominal maximum transmit power with which the STA is capable of transmitting in the current channel, with a tolerance ± 5 dB. The field is coded as a signed integer in units of decibels relative to 1 mW. Further interpretation of this field is defined in 10.8.3.

8.4.2.22 Secondary Channel Offset element

Change the first paragraph of 8.4.2.22 as follows:

The Secondary Channel Offset element is used by an AP in a BSS, a STA in an IBSS, or a mesh STA in an MBSS ~~together with the Channel Switch Announcement element~~ when changing to a new 40 MHz or wider channel. The format of the Secondary Channel Offset element is shown in Figure 8-103.

8.4.2.23 Measurement Request element

8.4.2.23.2 Basic request

Change the second paragraph of 8.4.2.23.2 as follows:

The Channel Number field is set to the channel number for which the measurement request applies ~~(as defined in 18.3.8.4.3)~~ where the channel number is a value from the "Channel set" column in Table E-4, in a row having the same value in the "Channel spacing (MHz)" column as the width of the primary channel of the BSS.

8.4.2.23.3 CCA request

Change the second paragraph of 8.4.2.23.3 as follows:

The Channel Number field is set to the channel number for which the measurement request applies ~~(as defined in 18.3.8.4.3)~~ where the channel number is a value from the "Channel set" column in Table E-4, in a row having the same value in the "Channel spacing (MHz)" column as the width of the primary channel of the BSS.

8.4.2.23.4 RPI histogram request

Change the second paragraph of 8.4.2.23.4 as follows:

The Channel Number field is set to the channel number for which the measurement request applies ~~(as defined in 18.3.8.4.3)~~ where the channel number is a value from the "Channel set" column in Table E-4, in a row having the same value in the "Channel spacing (MHz)" column as the width of the primary channel of the BSS.

8.4.2.23.5 Channel Load request

Change the second and third paragraphs of 8.4.2.23.5 (including combining them into one paragraph), and insert a subsequent note and new third paragraph as follows:

If the Wide Bandwidth Channel Switch subelement is not included, the Operating Class field indicates the operating class that identifies the channel set for which the measurement request applies. The Country, Operating Class, and Channel Number fields together specify the channel frequency and spacing for which the measurement request applies. Valid values of Operating Class operating classes are shown listed in Annex E, excluding operating classes that encompass a primary channel but do not identify the location of the primary channel. The Channel Number field indicates the channel number for which the measurement request applies. Channel Number is defined within an Operating Class operating class as shown in Annex E.

NOTE—Examples of operating classes that encompass a primary channel but do not identify the location of the primary channel are operating classes with a value of 80 or 160 in the “Channel Spacing (MHz)” column in the applicable table in Annex E.

If the Wide Bandwidth Channel Switch subelement is included, the fields in the Wide Bandwidth Channel Switch subelement indicate the channel for which the measurement request applies, and the Operating Class field and Channel Number field together specify the primary channel and primary 40 MHz channel within the channel identified by the Wide Bandwidth Channel Switch subelement.

Change Table 8-60 as follows:

Table 8-60—Optional subelement IDs for Channel Load Request

Subelement ID	Name	Length field (octets)	Extensible
0	Reserved		
1	Channel Load Reporting Information	2	Yes
2–162220	Reserved		
163	Wide Bandwidth Channel Switch	3	Yes
164–220	Reserved		
221	Vendor Specific	1 to 244	
222–255	Reserved		

Insert the following paragraph before the last paragraph of 8.4.2.23.5:

The Wide Bandwidth Channel Switch subelement has the same format as the corresponding element (see 8.4.2.163), with the constraint that the New Channel Width field indicates an 80 MHz, 160 MHz, or 80+80 MHz operating channel width.

8.4.2.23.6 Noise Histogram Request

Change the second and third paragraphs of 8.4.2.23.6 (including combining them into one paragraph), and insert a new third paragraph as follows:

If the Wide Bandwidth Channel Switch subelement is not included, the Operating Class field indicates the operating class that identifies the channel set for which the measurement request applies. The Country, Operating Class, and Channel Number fields together specify the channel frequency and spacing for which the measurement request applies. Valid values of Operating Class operating classes are shown listed in Annex E, excluding operating classes that encompass a primary channel but do not identify the location of the primary channel. The Channel Number field indicates the channel number for which the measurement request applies. Channel Number is defined within an Operating Class operating class as shown in Annex E.

If the Wide Bandwidth Channel Switch subelement is included, the fields in the Wide Bandwidth Channel Switch subelement indicate the channel for which the measurement request applies, and the Operating Class and Channel Number together specify the primary channel and primary 40 MHz channel within the channel identified by the Wide Bandwidth Channel Switch subelement.

Change Table 8-62 as follows:

Table 8-62—Optional subelement IDs for Noise Histogram Request

Subelement ID	Name	Length field (octets)	Extensible
0	Reserved		
1	Noise Histogram Reporting Information	2	Yes
2–162220	Reserved		
163	Wide Bandwidth Channel Switch	3	Yes
164–220	Reserved		
221	Vendor Specific	1 to 244	
222–255	Reserved		

Insert the following paragraph before the last paragraph of 8.4.2.23.6:

The Wide Bandwidth Channel Switch subelement has the same format as the corresponding element (see 8.4.2.163), with the constraint that the New Channel Width field indicates an 80 MHz, 160 MHz, or 80+80 MHz operating channel width.

8.4.2.23.7 Beacon Request

Change the second and third paragraphs (including creating several new paragraphs) in 8.4.2.23.7 as follows:

If the Wide Bandwidth Channel Switch subelement is not included, the Operating Class field indicates the operating class that identifies the channel set for which the measurement request applies. The Country, Operating Class, and Channel Number fields together specify the channel frequency and spacing for which the measurement request applies. Valid values of Operating Class operating classes are shown listed in Annex E.

For operating classes that encompass a primary channel but do not identify the location of the primary channel, the Channel Number field value is either 0 or 255; otherwise, the Channel Number field value is 0, 255, or Channel Number indicates the channel number for which the measurement request applies and Channel Number is defined within an Operating Class operating class as shown in Annex E.

For operating classes that identify the location of the primary channel, a Channel Number field value of 0 indicates a request to make iterative measurements for all supported channels in the Operating Class operating class where the measurement is permitted on the channel and the channel is valid for the current regulatory domain.

For operating classes that encompass a primary channel but do not identify the location of the primary channel, a Channel Number field value of 0 indicates a request to make iterative measurements for all primary channel positions within all requested and supported channels where the measurement is permitted on the channel and the channel is valid for the current regulatory domain.

For operating classes that identify the location of the primary channel, a Channel Number field value of 255 indicates a request to make iterative measurements for all supported channels in the current Operating Class operating class listed in the latest AP Channel Report received from the serving AP.

For operating classes that encompass a primary channel but do not identify the location of the primary channel, a Channel Number field value of 255 indicates a request to make iterative measurements for all primary channel positions within all channels listed in the AP Channel Report subelement where the channel is supported, the measurement is permitted on the channel, and the channel is valid for the current regulatory domain. The procedures for iterative measurements on multiple channels are described in 10.11.9.1.

If the Wide Bandwidth Channel Switch subelement is included, the fields in the Wide Bandwidth Channel Switch subelement indicate the channel for which the measurement report applies, and the Operating Class and Channel Number fields together specify the primary channel and primary 40 MHz channel within the channel identified by the Wide Bandwidth Channel Switch subelement.

Change the following rows in Table 8-65 as follows:

Table 8-65—Optional subelement IDs for Beacon Report

Subelement ID	Name	Length field (octets)	Extensible
52–162220	Reserved		
163	Wide Bandwidth Channel Switch	3	Yes
164–220	Reserved		

Change the second to last paragraph of 8.4.2.23.7 as follows:

The Request, AP Channel Report, and Vendor Specific subelements have the same format as their corresponding elements (see 8.4.2.13, 8.4.2.38, and 8.4.2.28, respectively). Multiple AP Channel Report and Vendor Specific subelements can be included in the list of optional subelements. An AP Channel Report subelement containing an operating class with an 80+ Behavior Limit (as defined in Annex E) is interpreted in conjunction with following AP Channel Report elements as defined in 10.11.9.1.

8.4.2.23.8 Frame request

Change the second and third paragraphs of 8.4.2.23.8 (including combining them into one paragraph), and insert a new third paragraph as follows:

If the Wide Bandwidth Channel Switch subelement is not included, the Operating Class field indicates the operating class that identifies the channel set for which the measurement request applies. The Country, Operating Class, and Channel Number fields together specify the channel frequency and spacing for which the measurement request applies. Valid values of Operating Class operating classes are shown listed in Annex E, excluding operating classes that encompass a primary channel but do not identify the location of the primary channel. The Channel Number field indicates the channel number for which the measurement report applies. Channel Number is defined within an Operating Class operating class as shown in Annex E.

If the Wide Bandwidth Channel Switch subelement is included, the fields in the Wide Bandwidth Channel Switch subelement indicate the channel for which the measurement request applies, and the Operating Class and Channel Number fields together specify the primary channel and primary 40 MHz channel within the channel identified by the Wide Bandwidth Channel Switch subelement.

Change Table 8-68 as follows:

Table 8-68—Optional subelement IDs for frame request

Subelement ID	Name	Length field (octets)	Extensible
0–162220	Reserved		
163	Wide Bandwidth Channel Switch	3	Yes
164–220	Reserved		
221	Vendor Specific	1 to 137	
222–255	Reserved		

Insert the following paragraph before the last paragraph of 8.4.2.23.8:

The Wide Bandwidth Channel Switch subelement has the same format as the corresponding element (see 8.4.2.163), with the constraint that the New Channel Width field indicates an 80 MHz, 160 MHz, or 80+80 MHz operating channel width.

8.4.2.24 Measurement Report element

8.4.2.24.2 Basic report

Change the second paragraph of 8.4.2.24.2 as follows:

The Channel Number field is set to the channel number to which the basic report applies ~~(as defined in 18.3.8.4.3)~~ where the Channel Number is a value from the “Channel set” column in Table E-4, in a row having the same value in the “Channel spacing (MHz)” column as the width of the primary channel of the BSS.

8.4.2.24.3 CCA report

Change the second paragraph of 8.4.2.24.3 as follows:

The Channel Number field contains the channel number to which the CCA report applies ~~(as defined in 18.3.8.4.3)~~ where the Channel Number is a value from the “Channel set” column in Table E-4, in a row having the same value in the “Channel spacing (MHz)” column as the width of the primary channel of the BSS.

8.4.2.24.4 RPI histogram report

Change the second paragraph of 8.4.2.24.4 as follows:

The Channel Number field is set to the channel number to which the RPI histogram report applies ~~(as defined in 18.3.8.4.3)~~ where the Channel Number is a value from the “Channel set” column in Table E-4, in a row having the same value in the “Channel spacing (MHz)” column as the width of the primary channel of the BSS.

8.4.2.24.5 Channel Load request

Change the second and third paragraphs of 8.4.2.24.5 (including combining them into one paragraph), and insert a new note and new third paragraph as follows:

If the Wide Bandwidth Channel Switch subelement is not included, the Operating Class field indicates the operating class that identifies the channel set for which the measurement request applies. The Country, Operating Class, and Channel Number fields together specify the channel frequency and spacing for which the measurement request applies. Valid values of Operating Class operating classes are shown listed in Annex E, excluding operating classes that encompass a primary channel but do not identify the location of the primary channel. The Channel Number field indicates the channel number for which the measurement request applies. Channel Number is defined within an Operating Class operating class as shown in Annex E.

NOTE—Examples of operating classes that encompass a primary channel but do not identify the location of the primary channel are operating classes with a value of 80 or 160 in the “Channel Spacing (MHz)” column of the applicable table in Annex E.

If the Wide Bandwidth Channel Switch subelement is included, the fields in the Wide Bandwidth Channel Switch subelement indicate the channel for which the measurement request applies, and the Operating Class and Channel Number fields together specify the primary channel and primary 40 MHz channel within the channel identified by the Wide Bandwidth Channel Switch subelement.

Change Table 8-83 as follows:

Table 8-83—Optional subelement IDs for Channel Load Report

Subelement ID	Name	Length field (octets)	Extensible
0–162220	Reserved		
163	<u>Wide Bandwidth Channel Switch</u>	3	<u>Yes</u>
164–220	<u>Reserved</u>		
221	Vendor Specific	1 to 237	
222–255	Reserved		

Insert the following paragraph before the last paragraph of 8.4.2.24.5:

The Wide Bandwidth Channel Switch subelement has the same format as the corresponding element (see 8.4.2.163), with the constraint that the New Channel Width field indicates an 80 MHz, 160 MHz, or 80+80 MHz operating channel width.

8.4.2.24.6 Noise Histogram Report

Change the second and third paragraphs of 8.4.2.24.6 (including combining them into one paragraph), and insert a new third paragraph as follows:

If the Wide Bandwidth Channel Switch subelement is not included, the Operating Class field indicates the operating class that identifies the channel set for which the measurement request applies. The Country, Operating Class, and Channel Number fields together specify the channel frequency and spacing for which the measurement request applies. Valid values of Operating Class operating classes are shown listed in

Annex E, excluding operating classes that encompass a primary channel but do not identify the location of the primary channel. The Channel Number field indicates the channel number for which the measurement report applies. Channel Number is defined within an Operating Class operating class as shown in Annex E.

If the Wide Bandwidth Channel Switch subelement is included, the fields in the Wide Bandwidth Channel Switch subelement indicate the channel for which the measurement report applies, and the Operating Class and Channel Number together specify the primary channel and primary 40 MHz channel within the channel identified by the Wide Bandwidth Channel Switch subelement.

Change Table 8-85 as follows:

Table 8-85—Optional subelement IDs for Noise Histogram Report

Subelement ID	Name	Length field (octets)	Extensible
0–162220	Reserved		
163	Wide Bandwidth Channel Switch	3	Yes
164–220	Reserved		
221	Vendor Specific	1 to 225	
222–255	Reserved		

8.4.2.24.7 Beacon Report

Change the second and third paragraphs of 8.4.2.24.7, and insert a new fourth paragraph as follows:

The Operating Class field indicates the operating class that identifies the channel set of the received Beacon or Probe Response frame channel set for which the measurement request applies. The Country, Operating Class, and Channel Number fields together specify the channel frequency and spacing of the received Beacon or Probe Response frame for which the measurement request applies. Valid values of Operating Class operating classes are shown listed in Annex E.

The Channel Number field indicates the channel number of the received Beacon or Probe Response frame for which the measurement report applies. Channel Number is defined within an Operating Class operating class as shown in Annex E.

If the PPDU carrying the received frame comprises noncontiguous frequency segments, the Operating Class and Channel Number fields identify the center frequency of frequency segment 0, and a Wide Bandwidth Channel Switch subelement is included.

8.4.2.24.8 Frame Report

Change the second and third paragraphs of 8.4.2.24.8 (including combining them into one paragraph), and insert a new third paragraph as follows:

If the Wide Bandwidth Channel Switch subelement is not included, the Operating Class field indicates the operating class that identifies the channel set for which the measurement request applies. The Country, Operating Class, and Channel Number fields together specify the channel frequency and spacing for which the measurement request applies. Valid values of Operating Class operating classes are shown listed in Annex E, excluding operating classes that encompass a primary channel but do not identify the location of

the primary channel. The Channel Number field indicates the channel number for which the measurement report applies. Channel Number is defined within an Operating Class operating class as shown in Annex E.

If the Wide Bandwidth Channel Switch subelement is included, the fields in the Wide Bandwidth Channel Switch subelement indicate the channel for which the measurement report applies, and the Operating Class and Channel Number fields together specify the primary channel and primary 40 MHz channel within the channel identified by the Wide Bandwidth Channel Switch subelement.

Change Table 8-87 as follows:

Table 8-87—Optional subelement IDs for Frame Report

Subelement ID	Name	Length field (octets)	Extensible
0	Reserved		
1	Frame Count Report	0 to 228	
2–162220	Reserved		
163	Wide Bandwidth Channel Switch	3	Yes
164–220	Reserved		
221	Vendor Specific	1 to 238	
222–255	Reserved		

Insert the following paragraph as the second to last paragraph of 8.4.2.24.8:

The Wide Bandwidth Channel Switch subelement has the same format as the corresponding element (see 8.4.2.163), with the constraint that the New Channel Width field indicates an 80 MHz, 160 MHz, or 80+80 MHz operating channel width.

8.4.2.27 RSNE

8.4.2.27.1 General

Change all (13) instances of “CCMP” to “CCMP-128” and the one instance of “BIP” to “BIP-CMAC-128” in the note in this subclause.

8.4.2.27.2 Cipher suites

Insert the following paragraph after the third paragraph (“The Pairwise Cipher Suite List field ...”) of 8.4.2.27.2:

The use of GCMP as a group cipher suite with a pairwise cipher suite other than GCMP is not supported.

Change the following rows in Table 8-99, insert the new rows into the table in numeric order, and change the reserved values accordingly:

Table 8-99—Cipher suite selectors

OUI	Suite type	Meaning
00-0F-AC	4	CCMP- <u>128</u> – default pairwise cipher suite and default group cipher suite for data frames in an RSNA
00-0F-AC	6	BIP- <u>CMAC-128</u> —default group management cipher suite in an RSNA with management frame protection enabled
00-0F-AC	8	GCMP- <u>128</u> – default for a DMG STA
<u>00-0F-AC</u>	9	<u>GCMP-256</u>
<u>00-0F-AC</u>	<u>10</u>	<u>CCMP-256</u>
<u>00-0F-AC</u>	<u>11</u>	<u>BIP-GMAC-128</u>
<u>00-0F-AC</u>	<u>12</u>	<u>BIP-GMAC-256</u>
<u>00-0F-AC</u>	<u>13</u>	<u>BIP-CMAC-256</u>

Change the now tenth paragraph of 8.4.2.27.2 as follows:

The cipher suite selector 00-0F-AC:4 (CCMP-128) is the default cipher suite value.

Change the following rows in Table 8-100, and insert the new rows at the end of the table:

Table 8-100—Cipher suite usage

Cipher suite selector	GTK	PTK	IGTK
CCMP- <u>128</u>	Yes	Yes	No
BIP- <u>CMAC-128</u>	No	No	Yes
GCMP- <u>128</u>	Yes	Yes	No
<u>GCMP-256</u>	<u>Yes</u>	<u>Yes</u>	<u>No</u>
<u>CCMP-256</u>	<u>Yes</u>	<u>Yes</u>	<u>No</u>
<u>BIP-GMAC-128</u>	<u>No</u>	<u>No</u>	<u>Yes</u>
<u>BIP-GMAC-256</u>	<u>No</u>	<u>No</u>	<u>Yes</u>
<u>BIP-CMAC-256</u>	<u>No</u>	<u>No</u>	<u>Yes</u>

8.4.2.27.3 AKM suites

Insert the following rows in Table 8-101 in numeric order, and change the reserved values accordingly:

Table 8-101—AKM suite selectors

OUI	Suite type	Meaning		
		Authentication type	Key management type	Key derivation type
00-0F-AC	11	Authentication negotiated over IEEE 802.1X or using PMKSA caching as defined in 11.5.9.3 using a Suite B compliant EAP method supporting EC of GF(p=256)	RSNA key management as defined in 11.6 or using PMKSA caching as defined in 11.5.9.3 with HMAC-SHA256	Defined in 11.6.1.7.2 using HMAC-SHA256
00-0F-AC	12	Authentication negotiated over IEEE 802.1X or using PMKSA caching as defined in 11.5.9.3 using a Suite B compliant EAP method supporting EC of GP(p=384)	RSNA key management as defined in 11.6 or using PMKSA caching as defined in 11.5.9.3 with HMAC-SHA384	Defined in 11.6.1.7.2 using HMAC-SHA384
00-0F-AC	13	FT authentication negotiated over IEEE 802.1X	FT key management as defined in 11.6.1.7 with HMAC-SHA384	Defined in 11.6.1.7.2 using HMAC-SHA384

Insert the following paragraph at the end of 8.4.2.27.3:

The AKM suite selector value 00-0F-AC:11 shall be used only with cipher suite selector values 00-0F-AC:8 (GCMP-128) and 00-0F-AC:11 (BIP-GMAC-128). The AKM suite selector value 00-0F-AC:12 shall be used only with cipher suite selector values 00-0F-AC:9 (GCMP-256), 00-0F-AC:10 (CCMP-256), 00-0F-AC:13 (BIP-CMAC-256), and 00-0F-AC:12 (BIP-GMAC-256).

8.4.2.29 Extended Capabilities element

Insert the following rows in Table 8-103, and change the reserved bits accordingly:

Table 8-103—Capabilities field

Bit	Information	Description
61	TDLS Wider Bandwidth	The TDLS Wider Bandwidth subfield indicates whether the STA supports a wider bandwidth than the BSS bandwidth for a TDLS direct link on the base channel. The field is set to 1 to indicate that the STA supports a wider bandwidth on the base channel and to 0 to indicate that the STA does not support a wider bandwidth on the base channel. A 160 MHz bandwidth is defined to be identical to an 80+80 MHz bandwidth (i.e., one is not wider than the other).

Table 8-103—Capabilities field (continued)

Bit	Information	Description
62	Operating Mode Notification	If dot11OperatingModeNotificationImplemented is true, the Operating Mode Notification field is set to 1 to indicate support for reception of the Operating Mode Notification element and the Operating Mode Notification frame. If dot11OperatingModeNotificationImplemented is false or not present, the Operating Mode Notification field is set to 0 to indicate lack of support for reception of the Operating Mode Notification element and the Operating Mode Notification frame.
63–64	Max Number Of MSDUs In A-MSDU	Indicates the maximum number of MSDUs in an A-MSDU that the STA is able to receive: Set to 0 to indicate that no limit applies. Set to 1 for 32. Set to 2 for 16. Set to 3 for 8 Reserved, if A-MSDU is not supported.

8.4.2.31 EDCA Parameter Set element

Change Table 8-105 as follows:

Table 8-105—Default EDCA Parameter Set element parameter values if dot11OCBActivated is false

AC	CWmin	CWmax	AIFSN	TXOP limit		
				For PHYs defined in Clause 16 and Clause 17	For PHYs defined in Clause 18, Clause 19, and Clause 20 , and Clause 22	Other PHYs
AC_BK	aCWmin	aCWmax	7	0	0	0
AC_BE	aCWmin	aCWmax	3	0	0	0
AC_VI	$(aCWmin+1)/2 - 1$	aCWmin	2	6.016 ms	3.008 ms	0
AC_VO	$(aCWmin+1)/4 - 1$	$(aCWmin+1)/2 - 1$	2	3.264 ms	1.504 ms	0

8.4.2.38 AP Channel Report element

Change the first paragraph of 8.4.2.38 as follows:

The AP Channel Report element contains a list of channels where a STA is likely to find an AP. The format of the AP Channel Report element is shown in Figure 8-214. See ~~40.11.6~~ 10.11.18 for details.

8.4.2.39 Neighbor Report element

Change Figure 8-216 as follows:

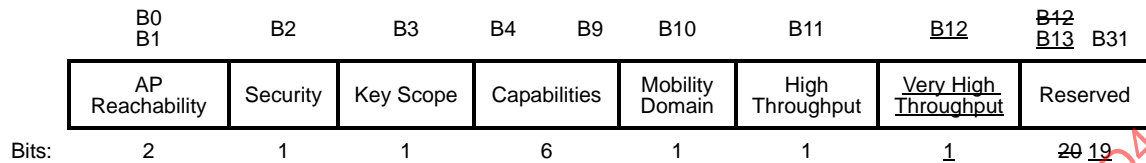

Figure 8-216—BSSID Information field

Insert the following paragraph after the 11th paragraph (“The High Throughput bit...”) of 8.4.2.39:

The Very High Throughput bit is set to 1 to indicate that the AP represented by this BSSID is a VHT AP and that the VHT Capabilities element, if included as a subelement in the report, is identical in content to the VHT Capabilities element included in the AP’s Beacon.

Change the now 13th, 14th, and 15th paragraphs of 8.4.2.39 as follows:

Bits 13–31 are reserved.

Operating Class field indicates the channel set of the AP indicated by this BSSID. The Country, Operating Class, and Channel Number fields together specify the channel frequency and spacing for the channel on which the Beacon frames are being transmitted for the BSS being reported AP indicated by this BSSID. Valid values of Operating Class operating classes are shown listed in Annex E.

The Channel Number field indicates the last known operating primary channel of the AP indicated by this BSSID. Channel Number is defined within an Operating Class operating class as shown in Annex E.

Change Table 8-115 as follows:

Table 8-115—Optional subelement IDs for neighbor report

Subelement ID	Name	Length field (octets)	Extensible
72–220	Reserved		
191	VHT Capabilities	12	Yes
192	VHT Operation	5	Yes
193–220	Reserved		

Insert the following paragraphs after the now 27th paragraph (“The Secondary Channel Offset subelement ...”) of 8.4.2.39:

The VHT Capabilities subelement is the same as the VHT Capabilities element as defined in 8.4.2.160.

The VHT Operation subelement is the same as the VHT Operation element as defined in 8.4.2.161.

8.4.2.40 RCPI element

Change the last paragraph of 8.4.2.40 as follows:

The RCPI field contains an RCPI value as specified for certain PHYs in Clause 16, Clause 18, Clause 17, Clause 19, ~~and Clause 20, and Clause 22.~~

8.4.2.48 Multiple BSSID element

Change the fourth bullet in the dashed list of the eighth paragraph of 8.4.2.48 as follows:

The Nontransmitted BSSID Profile subelement contains a list of elements for one or more APs or DMG STAs that have nontransmitted BSSIDs and is defined as follows:

- The Timestamp and Beacon Interval fields, DS Parameter Set, FH Parameter Set, IBSS Parameter Set, Country, FH Parameters, FH Pattern Table, Channel Switch Assignment, Extended Channel Switch Announcement, Wide Bandwidth Channel Switch, VHT Transmit Power Envelope, Supported Operating Classes, IBSS DFS, ERP Information, HT Capabilities, ~~and HT Operation~~, VHT Capabilities, and VHT Operation elements are not included in the Nontransmitted BSSID Profile field; the values of these elements for each nontransmitted BSSID are always the same as the corresponding transmitted BSSID element values.

8.4.2.56 Supported Operating Classes element

Change 8.4.2.56, including inserting two new figures (Figure 8-246a and Figure 8-246b), as follows:

The Supported Operating Classes element is used by a STA to advertise the operating classes that it is capable of operating with in this country. The format of the Supported Operating Classes element is shown in Figure 8-246.

	Element ID	Length	Current Operating Class	Operating Classes	Current Operating Class Extension Sequence (optional)	Operating Class Duplex Sequence (optional)
Octets:	1	1	1	Length-1 variable	variable	variable

Figure 8-246—Supported Operating Classes element format

The value of the Length field of the Supported Operating Classes element is between 2 and 253.

The Current Operating Class ~~octet~~ field, concatenated with the Current Operating Class Extension field within the Current Operating Class Extension Sequence field if present, indicates the operating class in use for transmission and reception. If the operating class in use is a single octet, the Current Operating Class Extension Sequence field is not present. If the operating class in use is more than a single octet, then the Current Operating Class Extension Sequence field is present, and the concatenation of the Current Operating Class field with the Current Operating Class Extension Sequence field comprises N (where $N \geq 0$) Operating Class octets with an 80+ Behavior Limit followed by one Operating Class octet without an 80+ Behavior Limit (as defined in Annex E).

The Operating Classes field lists in ascending order all single-octet operating classes that the STA is capable of operating with in this country. The Operating Classes field terminates immediately before a OneHundredAndThirty Delimiter (see Figure 8-246a), a Zero Delimiter (see Figure 8-246b), or the end of the element.

The format of the optional Current Operating Class Extension Sequence field is shown in Figure 8-246a.

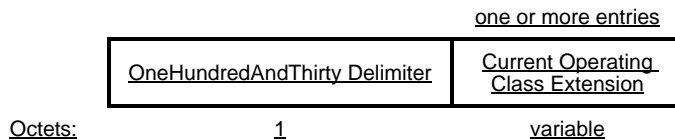

Figure 8-246a—Current Operating Class Extension Sequence field format

The OneHundredAndThirty Delimiter field is set to 130.

The Current Operating Class Extension field comprises N (where $N \geq 0$) Operating Class octets with an 80+ Behavior Limit followed by one Operating Class octet without an 80+ Behavior Limit (as defined in Annex E).

The format of the Operating Class Duple Sequence field is shown in Figure 8-246b.

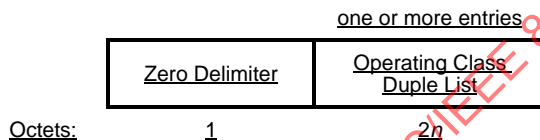

Figure 8-246b—Operating Class Duple Sequence field format

The Zero Delimiter is set to 0.

The Operating Class Duple List subfield lists all two-octet operating classes that the STA is capable of operating with in this country. Each operating class in the Operating Class Duple List subfield contains an Operating Class octet with an 80+ Behavior Limit followed by one Operating Class octet without an 80+ Behavior Limit (as defined in Annex E). Operating classes are transmitted in ascending order using the first octet in the operating class as the primary sort key and then the second octet in the operating class as the secondary sort key. If there are no two-octet operating classes that the STA is capable of operating with in this country, then the Operating Class Duple Sequence field is omitted from the Supported Operating Classes element. The Operating Class Duple List subfield terminates immediately before another zero octet or the end of the element.

The use of this element is described in ~~10.10.1~~ 10.10.2 and 10.11.9.1.

8.4.2.57 Management MIC element

Change Figure 8-247 as follows:

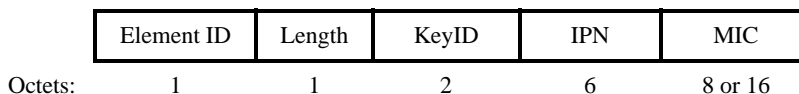

Figure 8-247—Management MIC element format

Change the third paragraph of 8.4.2.57 as follows:

The Length field is set to 16 or 24.

Change the last paragraph of 8.4.2.57 as follows:

The MIC field contains a message integrity code calculated over the robust management frame as specified in 11.4.4.5 and 11.4.4.6. The length of the MIC field depends on the specific cipher negotiated and is either 8 octets (for BIP) or 16 octets (for BIP-CMAC-256, BIP-GMAC-128, and BIP-GMAC-256).

8.4.2.58 HT Capabilities element

8.4.2.58.2 HT Capabilities Info field

Change the following row in Table 8-124:

Table 8-124—Subfields of the HT Capabilities Info field

Subfield	Definition	Encoding
Supported Channel Width Set	Indicates the channel widths supported by the STA. See 10.15.	Set to 0 if only 20 MHz operation is supported Set to 1 if both 20 MHz and 40 MHz operation is supported This field is reserved when the transmitting or receiving STA is operating in an <u>Operating Class that includes 20 in the Channel spacing (MHz) column an operating class that does not include a value of 13 or 14 in the behavior limits, as specified of the appropriate table in Annex E.</u>

8.4.2.58.4 Supported MCS Set field

Change the first paragraph of 8.4.2.58.4 as follows:

The Supported MCS Set field of the HT Capabilities element indicates which HT MCSs a STA supports.

Change the fifth paragraph of 8.4.2.58.4 as follows:

The Rx Highest Supported Data Rate subfield of the Supported MCS Set field defines the highest HT PPDU data rate that the STA is able to receive, in units of 1 Mb/s, where 1 represents 1 Mb/s, and incrementing by 1 Mb/s steps to the value 1023, which represents 1023 Mb/s. If the maximum data rate expressed in Mb/s is not an integer, then the value is rounded up-down to the next integer. The value 0 indicates that this subfield does not specify the highest HT PPDU data rate that the STA is able to receive; see 9.7.6.5.3.

8.4.2.58.5 HT Extended Capabilities field

Change Figure 8-252 as follows:

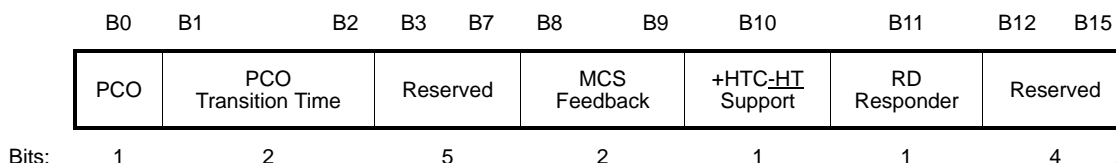

Figure 8-252—HT Extended Capabilities field

Change the following row in Table 8-127:

Table 8-127—Subfields of the HT Extended Capabilities field

Subfield	Definition	Encoding
+HTC- <u>HT</u> Support	Indicates support of the <u>HT variant</u> HT Control field. See 9.9.	Set to 0 if not supported Set to 1 if supported

8.4.2.58.6 Transmit Beamforming Capabilities

Change the following rows in Table 8-128:

Table 8-128—Subfields of the Transmit Beamforming Capabilities field

Subfield	Definition	Encoding
CSI Number of Beamformer Antennas Supported	Indicates the maximum number of beamformer antennas the <u>HT</u> beamformee can support when CSI feedback is required	Set to 0 for single Tx antenna sounding Set to 1 for 2 Tx antenna sounding Set to 2 for 3 Tx antenna sounding Set to 3 for 4 Tx antenna sounding
Noncompressed Steering Number of Beamformer Antennas Supported	Indicates the maximum number of beamformer antennas the <u>HT</u> beamformee can support when noncompressed beamforming feedback matrix is required	Set to 0 for single Tx antenna sounding Set to 1 for 2 Tx antenna sounding Set to 2 for 3 Tx antenna sounding Set to 3 for 4 Tx antenna sounding
Compressed Steering Number of Beamformer Antennas Supported	Indicates the maximum number of beamformer antennas the <u>HT</u> beamformee can support when compressed beamforming feedback matrix is required	Set to 0 for single Tx antenna sounding Set to 1 for 2 Tx antenna sounding Set to 2 for 3 Tx antenna sounding Set to 3 for 4 Tx antenna sounding
CSI Max Number of Rows Beamformer Supported	Indicates the maximum number of rows of CSI explicit feedback from the <u>HT</u> beamformee or calibration responder or transmit ASEL responder that an <u>HT</u> beamformer or calibration initiator or transmit ASEL initiator can support when CSI feedback is required.	Set to 0 for a single row of CSI Set to 1 for 2 rows of CSI Set to 2 for 3 rows of CSI Set to 3 for 4 rows of CSI

8.4.2.59 HT Operation element

Change the following row in Table 8-130:

Table 8-130—HT Operation element fields and subfields

Subfield	Definition	Encoding	Reserved in IBSS?	Reserved in MBSS?
Basic MCS Set	Indicates the HT MCS values that are supported by all HT STAs in the BSS. Present in Beacon, Probe Response, Mesh Peering Open, and Mesh Peering Confirm frames. Otherwise, reserved.	The Basic MCS Set is a bitmap of size 128 bits. Bit 0 corresponds to MCS 0. A bit is set to 1 to indicate support for that MCS and 0 otherwise. MCS values are defined in 8.4.2.58.4.	N	N

8.4.2.69 Event Request element**8.4.2.69.4 Peer-to-Peer Link event request**

Change the eighth paragraph of 8.4.2.69.4 as follows:

The Channel Number subelement(s) identifies identify the channel for the Peer-to-Peer links to be reported. Excluding this subelement from the Event Request element indicates a request for Peer-to-Peer Link events for any channel. The format of the Channel Number subelement is shown in Figure 8-280. The identified channel is indicated by $N+1$ Channel Number subelements where the first N subelements contains an Operating Class octet with an 80+ Behavior Limit and the last subelement contains an Operating Class octet without an 80+ Behavior Limit (as defined in Annex E).

Change the 12th paragraph of 8.4.2.69.4 as follows:

The Channel Number field indicates the channel number, or center frequency index of the frequency segment if the identified channel comprises noncontiguous frequency segments, of the Peer-to-Peer Link events requested and included in the Peer-to-Peer Link event report. A Channel Number of 0 in all $N+1$ Channel Number subelements indicates a request to report any Peer-to-Peer Link event for any supported channel in the specified filtering Operating Class.

8.4.2.70 Event Report element**8.4.2.70.4 Peer-to-Peer Link event report**

Change the sixth paragraph of 8.4.2.70.4 follows:

The STA Tx Power field indicates the target transmit power at the antenna (i.e., EIRP) in dBm with a tolerance of ± 5 dB of the lowest basic rate of the reporting STA.

8.4.2.71 Diagnostic Request element**8.4.2.71.5 Diagnostic Information subelement descriptions**

Insert the following paragraph and note into 8.4.2.71.5 after Figure 8-290:

The set of current operating classes and channel widths of the AP is indicated by $N+1$ AP descriptor subelements where the first N subelements contain an Operating Class octet with an 80+ Behavior Limit and the last subelement contains an Operating Class octet without an 80+ Behavior Limit (as defined in Annex E).

NOTE—An 80+80 MHz AP sends four AP descriptor subelements for 20/40 MHz, 80 MHz, 80+ MHz (for the secondary 80 MHz frequency segment), and 80 MHz (for the primary 80 MHz frequency segment).

Change the now 12th and 13th paragraphs of 8.4.2.71.5 as follows:

The Operating Class field contains an enumerated value from Annex E specifying a channel width or frequency segment index and width (if the indicated channel comprises noncontiguous frequency segments) as well as the frequency band in which the Channel Number is valid.

The Channel Number field indicates the a current operating channel, or a center frequency index of the frequency segment (if the indicated channel comprises noncontiguous frequency segments), of the AP identified by the BSSID in the AP Descriptor.

Insert the following row into Table 8-147 in numeric order, and change the reserved values accordingly:

Table 8-147—Power Save Mode definition

Power Save Mode	Bit
TXOP Power Save	15

Change the now 52nd paragraph of 8.4.2.71.5 as follows:

The Tx Power field indicates the target transmit power level(s) at the antenna(s) (i.e., EIRP), where the actual power is within ± 5 dB to the target. Each transmit power level is encoded in a single octet as a two's complement value in dBm, rounded to the nearest integer. If the Tx Power Mode field is 0, then the Tx Power field contains one or more transmit power levels in increasing numerical order. If the Tx Power Mode field is 1, the Tx Power field contains the STA's minimum and nonzero maximum transmit power levels, in that order.

8.4.2.73 Location Parameters element**8.4.2.73.3 Location Indication Channels subelement**

Insert the following paragraph at the end of 8.4.2.73.3:

Channel Entry fields may be grouped together to identify a noncontiguous channel. A noncontiguous channel is indicated by a group of $N+1$ Channel Entry fields where the first N Channel Entry fields contain an Operating Class field with an 80+ Behavior Limit and the last Channel Entry field in the group contains an Operating Class octet without an 80+ Behavior Limit (as defined in Annex E).

8.4.2.73.5 Radio Information subelement

Change the fourth paragraph of 8.4.2.73.5 as follows:

The Transmit Power field is the transmit power used to transmit the current Location Track Notification frame containing the Location Parameters element with the Radio Information subelement and is a signed integer, 1 octet in length, reported as an EIRP in dBm. A value of -128 indicates that the transmit power is unknown. The tolerance for the transmit power value reported in the Radio Information subelement is ± 5 dB. This tolerance is defined as the maximum possible difference, in decibels, between the reported power value and the total transmitted power across all antennas of the STA, which are measured when transmitting Location Request frames.

8.4.2.73.8 Time of Departure subelement

Change the fifth paragraph of 8.4.2.73.8 as follows:

The TOD RMS field specifies the RMS time of departure error in units equal to $1/\text{TOD Clock Rate}$, where the TOD Clock Rate is specified in the TOD Clock Rate field, where the time of departure error equals the difference between the TOD Timestamp field and the time of departure measured by a reference entity using a clock synchronized to the start time and mean frequency of the local PHY entity's clock. The TOD RMS field is determined from aTxPmdTxStartRMS for a non-VHT PPDU or from aTxPHYTxStartRMS for a VHT PPDU in units equal to $1/\text{TOD Clock Rate}$, where the TOD Clock Rate is specified in the TOD Clock Rate field.

8.4.2.88 Channel Usage element

Change the fifth paragraph of 8.4.2.88 as follows:

The Channel Entry field includes zero or more Operating Class and Channel pairs. The format of the Channel Entry field is shown in Figure 8-313. Channel Entry fields may be grouped together to identify a noncontiguous channel as described in 8.4.2.73.3.

Insert the following subclauses, 8.4.2.160 to 8.4.2.168 (including Figure 8-401bp to Figure 8-401cc and Table 8-183v to Table 8-183z), after 8.4.2.159:

8.4.2.160 VHT Capabilities element

8.4.2.160.1 VHT Capabilities element structure

A VHT STA declares that it is a VHT STA by transmitting the VHT Capabilities element.

The VHT Capabilities element contains a number of fields that are used to advertise VHT capabilities of a VHT STA. The VHT Capabilities element is defined in Figure 8-401bp.

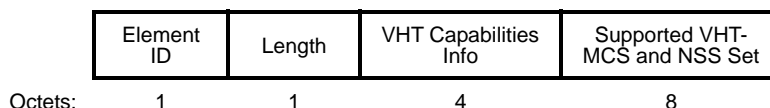

Figure 8-401bp—VHT Capabilities element format

The Element ID field is set to the value for VHT Capabilities element defined in Table 8-54.

The Length field of the VHT Capabilities element is set to 12.

8.4.2.160.2 VHT Capabilities Info field

The structure of the VHT Capabilities Info field is defined in Figure 8-401bq.

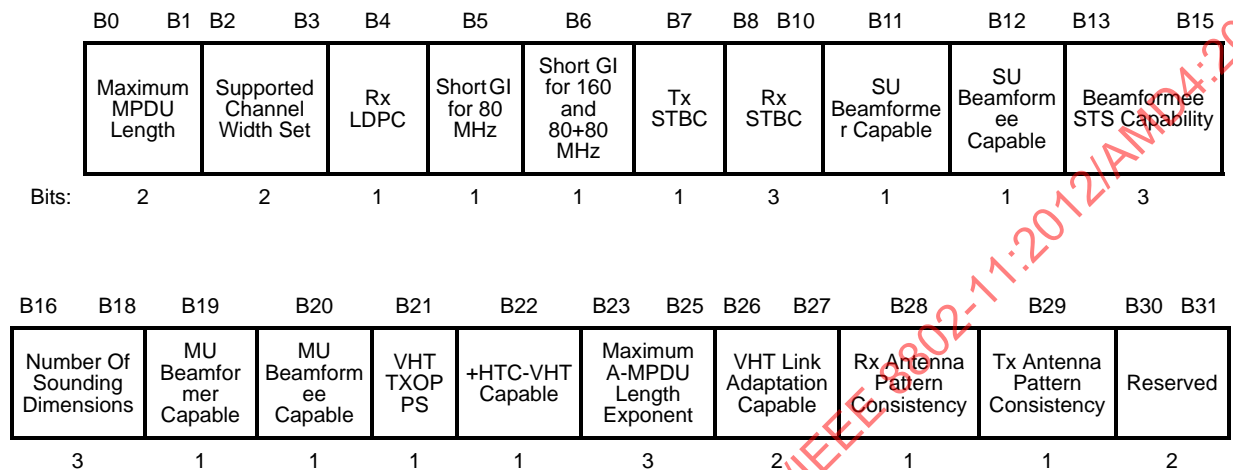

Figure 8-401bq—VHT Capabilities Info field

The subfields of the VHT Capabilities Info field are defined in Table 8-183v.

Table 8-183v—Subfields of the VHT Capabilities Info field

Subfield	Definition	Encoding
Maximum MPDU Length	Indicates the maximum MPDU length (see 9.11).	Set to 0 for 3895 octets. Set to 1 for 7991 octets. Set to 2 for 11 454 octets. The value 3 is reserved.
Supported Channel Width Set	Indicates the channel widths supported by the STA. See 10.39.	Set to 0 if the STA does not support either 160 or 80+80 MHz. Set to 1 if the STA supports 160 MHz. Set to 2 if the STA supports 160 MHz and 80+80 MHz. The value 3 is reserved.
Rx LDPC	Indicates support for receiving LDPC encoded packets.	Set to 0 if not supported. Set to 1 if supported.
Short GI for 80 MHz	Indicates short GI support for the reception of packets transmitted with TXVECTOR parameters FORMAT equal to VHT and CH_BANDWIDTH equal to CBW80.	Set to 0 if not supported. Set to 1 if supported.

Table 8-183v—Subfields of the VHT Capabilities Info field (continued)

Subfield	Definition	Encoding
Short GI for 160 and 80+80 MHz	Indicates short GI support for the reception of packets transmitted with TXVECTOR parameters FORMAT equal to VHT and CH_BANDWIDTH equal to CBW160 or CBW80+80.	Set to 0 if not supported. Set to 1 if supported.
Tx STBC	Indicates support for the transmission of at least 2x1 STBC.	Set to 0 if not supported. Set to 1 if supported.
Rx STBC	Indicates support for the reception of PPDU's using STBC.	Set to 0 for no support. Set to 1 for support of one spatial stream. Set to 2 for support of one and two spatial streams. Set to 3 for support of one, two, and three spatial streams. Set to 4 for support of one, two, three, and four spatial streams. The values 5, 6, 7 are reserved.
SU Beamformer Capable	Indicates support for operation as an SU beamformer (see 9.31.5).	Set to 0 if not supported. Set to 1 if supported.
SU Beamformee Capable	Indicates support for operation as an SU beamformee (see 9.31.5).	Set to 0 if not supported. Set to 1 if supported.
Beamformee STS Capability	The maximum number of space-time streams that the STA can receive in a VHT NDP, the maximum value for $N_{STS,total}$ that can be sent to the STA in a VHT MU PPDU if the STA is MU beamformee capable, and the maximum value of N_r that the STA transmits in a VHT Compressed Beamforming frame.	If SU beamformee capable, set to maximum number of space-time streams that the STA can receive in a VHT NDP minus 1. Otherwise, reserved.
Number of Sounding Dimensions	Beamformer's capability indicating the maximum value of the TXVECTOR parameter NUM_STS for a VHT NDP.	If SU beamformer capable, set to the maximum supported value of the TXVECTOR parameter NUM_STS minus 1. Otherwise, reserved.
MU Beamformer Capable	Indicates support for operation as an MU beamformer (see 9.31.5).	Set to 0 if not supported or if SU Beamformer Capable is set to 0 or if sent by a non-AP STA. Set to 1 if supported and SU Beamformer Capable is set to 1.
MU Beamformee Capable	Indicates support for operation as an MU beamformee (see 9.31.5).	Set to 0 if not supported or if SU Beamformee Capable is set to 0 or if sent by an AP. Set to 1 if supported and SU Beamformee Capable is set to 1.

Table 8-183v—Subfields of the VHT Capabilities Info field (continued)

Subfield	Definition	Encoding
VHT TXOP PS	Indicates whether the AP supports VHT TXOP Power Save Mode or whether the non-AP STA has enabled VHT TXOP Power Save mode.	Set to 0 if the AP does not support TXOP Power Save Mode. Set to 1 if the AP supports TXOP Power Save Mode. Set to 0 if the non-AP STA does not enable TXOP Power Save Mode. Set to 1 if the non-AP STA enables TXOP Power Save Mode.
+HTC-VHT Capable	Indicates whether the STA supports receiving a VHT variant HT Control field.	Set to 0 if not supported. Set to 1 if supported.
Maximum A-MPDU Length Exponent	Indicates the maximum length of A-MPDU that the STA can receive. EOF padding is not included in this limit.	This field is an integer in the range of 0 to 7. The length defined by this field is equal to $2^{(13 + \text{Maximum A-MPDU Length Exponent})} - 1$ octets.
VHT Link Adaptation Capable	Indicates whether the STA supports link adaptation using VHT variant HT Control field.	If +HTC-VHT Capable is 1: Set to 0 (No Feedback) if the STA does not provide VHT MFB. Set to 2 (Unsolicited) if the STA provides only unsolicited VHT MFB. Set to 3 (Both) if the STA can provide VHT MFB in response to VHT MRQ and if the STA provides unsolicited VHT MFB. The value 1 is reserved. Reserved if +HTC-VHT Capable is 0.
Rx Antenna Pattern Consistency	Indicates the possibility of a receive antenna pattern change.	Set to 0 if the receive antenna pattern might change during the lifetime of the current association. Set to 1 if the receive antenna pattern does not change during the lifetime of the current association. See 10.39.6.
Tx Antenna Pattern Consistency	Indicates the possibility of a transmit antenna pattern change.	Set to 0 if the transmit antenna pattern might change during the lifetime of the current association. Set to 1 if the transmit antenna pattern does not change during the lifetime of the current association. See 10.39.6.
<p>NOTE 1—An AP that sets MU Beamformer Capable to 1 can transmit a VHT MU PPDU with only one nonzero TXVECTOR parameter NUM_STS[p], for $0 \leq p \leq 3$. However, a STA that sets MU Beamformee Capable to 0 is not required to be able to demodulate a VHT MU PPDU with only one nonzero RXVECTOR parameter NUM_STS[p], for $0 \leq p \leq 3$.</p> <p>NOTE 2—The value for the Maximum MPDU Length in the VHT Capabilities Info field imposes a constraint on the allowed value of the Maximum MPDU Length in the HT Capabilities Info field of the HT Capabilities element carried in the same frame (see 9.11).</p>		

Support for short GI for the reception of packets with TXVECTOR parameter CH_BANDWIDTH equal to CBW20 or CBW40 is indicated in the HT Capabilities Info field of the HT Capabilities element.

8.4.2.160.3 Supported VHT-MCS and NSS Set field

The Supported VHT-MCS and NSS Set field is used to convey the combinations of VHT-MCSs and spatial streams that a STA supports for reception and the combinations that it supports for transmission. The structure of the field is shown in Figure 8-401br.

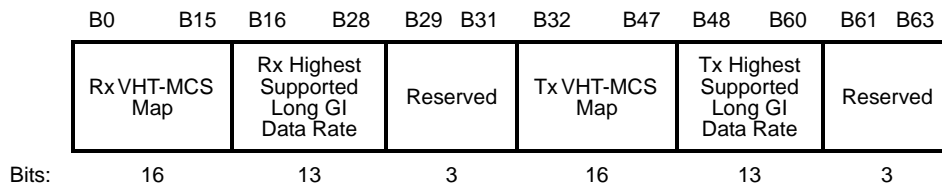

Figure 8-401br—Supported VHT-MCS and NSS Set field

The Supported VHT-MCS and NSS Set subfields are defined in Table 8-183w.

Table 8-183w—Supported VHT-MCS and NSS Set subfields

Subfield	Definition	Encoding
Rx VHT-MCS Map	Indicates the maximum value of the RXVECTOR parameter MCS of a PPDU that can be received at all channel widths supported by this STA for each number of spatial streams.	The format and encoding of this subfield are defined in Figure 8-401bs and the associated description.
Rx Highest Supported Long GI Data Rate	Indicates the highest long GI VHT PPDU data rate that the STA is able to receive.	The largest integer value less than or equal to the highest long GI VHT PPDU data rate in Mb/s the STA is able to receive (see 9.7.11.1). The value 0 indicates that this subfield does not specify the highest long GI VHT PPDU data rate that the STA is able to receive.
Tx VHT-MCS Map	Indicates the maximum value of the TXVECTOR parameter MCS of a PPDU that can be transmitted at all channel widths supported by this STA for each number of spatial streams.	The format and encoding of this subfield are defined in Figure 8-401bs and the associated description.
Tx Highest Supported Long GI Data Rate	Indicates the highest long GI VHT PPDU data rate that the STA is able to transmit at.	The largest integer value less than or equal to the highest long GI VHT PPDU data rate in Mb/s that the STA is able to transmit (see 9.7.11.2). The value 0 indicates that this subfield does not specify the highest long GI VHT PPDU data rate that the STA is able to transmit.

The Rx VHT-MCS Map subfield and the Tx VHT-MCS Map subfield have the structure shown in Figure 8-401bs.

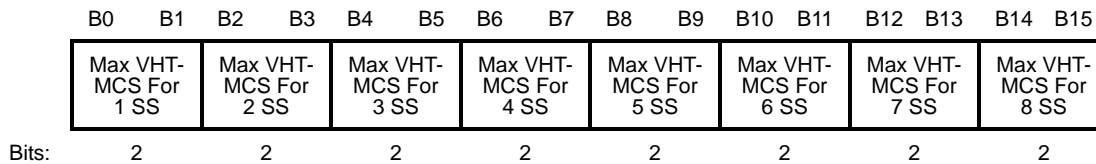

Figure 8-401bs—Rx VHT-MCS Map and Tx VHT-MCS Map subfields and Basic VHT-MCS and NSS Set field

The Max VHT-MCS For n SS subfield (where $n = 1, \dots, 8$) is encoded as follows:

- 0 indicates support for VHT-MCS 0-7 for n spatial streams
- 1 indicates support for VHT-MCS 0-8 for n spatial streams
- 2 indicates support for VHT-MCS 0-9 for n spatial streams
- 3 indicates that n spatial streams is not supported

NOTE—A VHT-MCS indicated as supported in the VHT-MCS Map fields for a particular number of spatial streams might not be valid at all bandwidths (see 22.5) and might be limited by the declaration of Tx Highest Supported Long GI Data Rates and Rx Highest Supported Long GI Data Rates and might be affected by 9.7.11.3.

8.4.2.161 VHT Operation element

The operation of VHT STAs in the BSS is controlled by the HT Operation element and the VHT Operation element. The format of the VHT Operation element is defined in Figure 8-401bt.

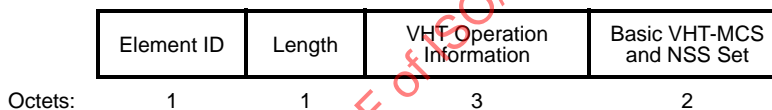

Figure 8-401bt—VHT Operation element format

The Element ID field is set to the value for VHT Operation element defined in Table 8-54.

The structure of the VHT Operation Information field is defined in Figure 8-401bu.

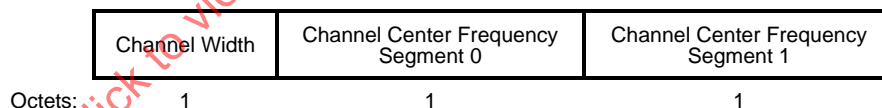

Figure 8-401bu—VHT Operation Information field

The VHT STA gets the primary channel information from the HT Operation element. The subfields of the VHT Operation Information field are defined in Table 8-183x.

The Basic VHT-MCS and NSS Set field indicates the VHT-MCSs for each number of spatial streams in VHT PPDU that are supported by all VHT STAs in the BSS (including IBSS and MBSS). The Basic VHT-MCS and NSS Set field is a bitmap of size 16 bits; each 2 bits indicates the supported VHT-MCS set for N_{SS} from 1 to 8. The Basic VHT-MCS and NSS Set field is defined in Figure 8-401bs.

Table 8-183x—VHT Operation Information subfields

Field	Definition	Encoding
Channel Width	This field, together with the HT Operation element STA Channel Width field, defines the BSS operating channel width (see 10.39.1).	Set to 0 for 20 MHz or 40 MHz operating channel width. Set to 1 for 80 MHz operating channel width. Set to 2 for 160 MHz operating channel width. Set to 3 for 80+80 MHz operating channel width. Values in the range 4 to 255 are reserved.
Channel Center Frequency Segment 0	Defines the channel center frequency for an 80 and 160 MHz VHT BSS and the frequency segment 0 channel center frequency for an 80+80 MHz VHT BSS. See 22.3.14.	For 80 MHz or 160 MHz operating channel width, indicates the channel center frequency index for the 80 MHz or 160 MHz channel on which the VHT BSS operates. For 80+80 MHz operating channel width, indicates the channel center frequency index for the 80 MHz channel of frequency segment 0 on which the VHT BSS operates. Reserved otherwise.
Channel Center Frequency Segment 1	Defines the frequency segment 1 channel center frequency for an 80+80 MHz VHT BSS. See 22.3.14.	For an 80+80 MHz operating channel width, indicates the channel center frequency index of the 80 MHz channel of frequency segment 1 on which the VHT BSS operates. Reserved otherwise.

8.4.2.162 Extended BSS Load element

The Extended BSS Load element reported by the AP contains information on MIMO spatial stream underutilization and bandwidth utilization. The element format is defined in Figure 8-401bv. A STA receiving the element might use the information it conveys in an implementation-specific AP selection algorithm.

Element ID	Length	MU-MIMO Capable STA Count	Spatial Stream Underutilization	Observable Secondary 20 MHz Utilization	Observable Secondary 40 MHz Utilization	Observable Secondary 80 MHz Utilization
Octets: 1	1	2	1	1	1	1

Figure 8-401bv—Extended BSS Load element format

The Element ID field is set to the value for the Extended BSS Load element in Table 8-54.

The Length field is set to 6.

The MU-MIMO Capable STA Count field indicates the total number of STAs currently associated with this BSS that have a 1 in the MU Beamformee Capable field of their VHT Capabilities element.

The Spatial Stream Underutilization field is defined as the percentage of time, linearly scaled with 255 representing 100%, that the AP has underutilized spatial domain resources for given busy time of the medium. The spatial stream underutilization is calculated only for the primary channel. This percentage is computed using the formula,

$$\text{Spatial Stream Underutilization} = \left\lceil \frac{N_{\text{max_SS}} \times T_{\text{busy}} - T_{\text{utilized}}}{N_{\text{max_SS}} \times T_{\text{busy}}} \times 255 \right\rceil$$

where

$N_{\text{max_SS}}$ is the maximum number of spatial streams supported by the AP.

T_{busy} is the number of microseconds during which CCA indicated the channel was busy during the measurement duration. The resolution of the CCA busy measurement is in microseconds.

T_{utilized} is $\sum_{i=1}^N N_{SS,i} T_i$, where T_i is the time interval, in units of microseconds, during which the primary 20 MHz channel is busy due to the transmission of one or more spatial streams by the AP to MU-capable STAs; $N_{SS,i}$ is the number of spatial streams transmitted during the time interval T_i ; and N is the number of busy events that occurred during the total measurement time which is less than or equal to `dot11ChannelUtilizationBeaconIntervals` consecutive beacon intervals.

If T_{busy} is 0, the Spatial Stream Underutilization field is reserved.

The measurement of the observable loading on each of the secondary 20 MHz channel, secondary 40 MHz channel, and secondary 80 MHz channel in conjunction with the measurement on the primary 20 MHz channel provides a STA with the loading on the 40 MHz, 80 MHz, 160 MHz, and 80+80 MHz channels.

The Observable Secondary 20 MHz Utilization, Observable Secondary 40 MHz Utilization, and Observable Secondary 80 MHz Utilization fields are defined using Equation (8-3).

$$\text{Observable Secondary } W1 \text{ Utilization} = \left[\frac{T_{\text{busy}, W1}}{\text{dot11ChannelUtilizationBeaconIntervals} \times \text{dot11BeaconPeriod} \times 1024} \times 255 \right] \quad (8-3)$$

where

`dot11ChannelUtilizationBeaconIntervals` represents the number of consecutive beacon intervals during which the secondary channel busy time is measured.

$T_{\text{busy}, W1}$ is computed as the sum of the times from `PHY-CCA.indication(BUSY, {W2})` to the next issue of a `PHY-CCA.indication` primitive and that overlap the measurement interval, for $W1 = 20, 40,$ or $80,$ and where $W2$ equals `secondary`, `secondary40`, or `secondary80` for $W1 = 20, 40,$ or $80,$ respectively.

If the AP indicates a channel width of 20 MHz, 40 MHz, or 80 MHz in the STA Channel Width field in the HT Operation element and in the Channel Width field in the VHT Operation element, then the Observable Secondary 80 MHz Utilization field is reserved. If the AP indicates a channel width of 20 MHz or 40 MHz in the STA Channel Width field in the HT Operation element, then the Observable Secondary 40 MHz Utilization field is reserved. If the AP indicates a channel width of 20 MHz in the STA Channel Width field in the HT Operation element, then the Observable Secondary 20 MHz Utilization field is reserved.

8.4.2.163 Wide Bandwidth Channel Switch element

The Wide Bandwidth Channel Switch element is included in Channel Switch Announcement frames, as described in 8.5.2.6 (Channel Switch Announcement frame format), Extended Channel Switch Announcement frames, as described in 8.5.8.7, and TDLS Channel Switch Request frames, as described in 8.5.13.7 (TDLS Channel Switch Request frame format). The format of the Wide Bandwidth Channel Switch element is shown in Figure 8-401bw.

Element ID	Length	New Channel Width	New Channel Center Frequency Segment 0	New Channel Center Frequency Segment 1
Octets: 1	1	1	1	1

Figure 8-401bw—Wide Bandwidth Channel Switch element format

The Element ID field is set to the value for the Wide Bandwidth Channel Switch element in Table 8-54.

The Length field is set to 3.

The subfields New Channel Width, New Channel Center Frequency Segment 0, and New Channel Center Frequency Segment 1 have the same definition, respectively, as Channel Width, Channel Center Frequency Segment 0, and Channel Center Frequency Segment 1 in the VHT Operation Information field, described in Table 8-183x.

8.4.2.164 VHT Transmit Power Envelope element

The VHT Transmit Power Envelope element conveys the local maximum transmit power for various transmission bandwidths. The format of the VHT Transmit Power Envelope element is shown in Figure 8-401bx.

Element ID	Length	Transmit Power Information	Local Maximum Transmit Power For 20 MHz	Local Maximum Transmit Power For 40 MHz	Local Maximum Transmit Power For 80 MHz	Local Maximum Transmit Power For 160/80+80 MHz
Octets: 1	1	1	1	0 or 1	0 or 1	0 or 1

Figure 8-401bx—VHT Transmit Power Envelope element format

The Element ID field is set to the value for the VHT Transmit Power Envelope element defined in Table 8-54.

The Length field specifies the number of octets in the element following the Length field.

The format of the Transmit Power Information field is defined in Figure 8-401by.

Bits:	B0	B2	B3	B5	B6	B7
	Local Maximum Transmit Power Count	Local Maximum Transmit Power Unit Interpretation		Reserved		

Figure 8-401by—Transmit Power Information field

The Local Maximum Transmit Power Count subfield indicates the number of Local Maximum Transmit Power For X MHz fields (where X = 20, 40, 80, or 160/80+80) minus 1 in the VHT Transmit Power Envelope element, as shown in Table 8-183y.

The Local Maximum Transmit Power Unit Interpretation subfield provides additional interpretation for the units of the Local Maximum Transmit Power For X MHz fields (where X = 20, 40, 80, or 160/80+80) and is defined in Table 8-183z. Allowed values are further constrained as defined in Annex E.

Table 8-183y—Meaning of Local Maximum Transmit Power Count subfield

Value	Field(s) present
0	Local Maximum Transmit Power For 20 MHz.
1	Local Maximum Transmit Power For 20 MHz and Local Maximum Transmit Power For 40 MHz.
2	Local Maximum Transmit Power For 20 MHz, Local Maximum Transmit Power For 40 MHz, and Local Maximum Transmit Power For 80 MHz.
3	Local Maximum Transmit Power For 20 MHz, Local Maximum Transmit Power For 40 MHz, Local Maximum Transmit Power For 80 MHz, and Local Maximum Transmit Power For 160/80+80 MHz.
4–7	Reserved

Table 8-183z—Definition of Local Maximum Transmit Power Unit Interpretation subfield

Value	Unit interpretation of the Local Maximum Transmit Power For X MHz fields
0	EIRP
1–7	Reserved

NOTE—This table is expected to be updated only if regulatory domains mandate the use of transmit power control with limits that cannot be converted into an EIRP value per PDU bandwidth.

Local Maximum Transmit Power For X MHz fields (where X = 20, 40, 80, or 160/80+80) define the local maximum transmit power limit of the transmission bandwidth X MHz. Each Local Maximum Transmit Power For X MHz field is encoded as an 8-bit two's complement signed integer in the range of –64 dBm to 63 dBm with a 0.5 dB step. The value of 63.5 dBm indicates 63.5 dBm or higher (i.e., no local maximum transmit power constraint).

8.4.2.165 Channel Switch Wrapper element

The Channel Switch Wrapper element contains subelements that indicate characteristics of the BSS after a channel switch. The format of the Channel Switch Wrapper element is defined in Figure 8-401bz.

Element ID	Length	New Country subelement (optional)	Wide Bandwidth Channel Switch subelement (optional)	New VHT Transmit Power Envelope subelement (optional)
Octets: 1	1	variable	variable	variable

Figure 8-401bz—Channel Switch Wrapper element format

The Element ID field is set to the value for the Channel Switch Wrapper element in Table 8-54.

The Length field specifies the number of octets in the element following the Length field.

The New Country subelement is present when an AP or mesh STA performs extended channel switching to a new Country, new Operating Class Table, or a changed set of operating classes relative to the contents of the Country element sent in the Beacon; otherwise, this subelement is not present. The format of the New Country subelement is defined to be the same as the format of the Country element (see 8.4.2.10), except that no Subband Triplet fields are present in the New Country subelement. The Country String field in the New Country subelement indicates the Country and Operating Class Table of the BSS after extended channel switching, and Operating Triplet fields within the New Country subelement indicate the operating classes of the BSS after extended channel switching (see 10.39.1).

The Wide Bandwidth Channel Switch subelement is present under the following conditions:

- Channel switching to a BSS operating channel width of 40 MHz or wider
- Extended channel switching to a BSS operating channel width of 80 MHz or wider

The Wide Bandwidth Channel Switch subelement is optionally present if extended channel switching to a BSS operating channel width of 40 MHz. The Wide Bandwidth Channel Switch subelement is not present if channel switching to a 20 MHz BSS operating channel width.

The format of the Wide Bandwidth Channel Switch subelement is the same as the Wide Bandwidth Channel Switch element (see 8.4.2.163) except for the following:

- A value 0 in the New Channel Width field signifies only a 40 MHz BSS Operating Channel Width.
- When switching to a 40 MHz BSS operating channel width, the New Channel Center Frequency Segment 0 field indicates the channel center frequency index for the 40 MHz channel after the channel switch.

If present, the Wide Bandwidth Channel Switch subelement indicates the BSS operating channel width after channel switching (see 10.39.1). For example, when switching to a 40 MHz operating channel width on channel indices 36 and 40, the New Channel Width field is set to 0, and the New Channel Center Frequency Segment 0 field is set to 38.

Each New VHT Transmit Power Envelope subelement that is present is defined to have the same format as the VHT Transmit Power Envelope element (see 8.4.2.164) and includes a distinct value of the Local Maximum Transmit Power Unit Interpretation subfield. Each New VHT Transmit Power Envelope subelement indicates the local maximum transmit powers for the BSS for the indicated bandwidths with an indicated unit interpretation after channel switching (see 10.39.1).

8.4.2.166 AID element

The AID element includes the AID assigned by an AP during association that represents the 16-bit ID of a STA. The format of the AID element is shown in Figure 8-401ca.

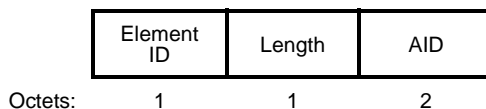

Figure 8-401ca—AID element format

The Element ID field is set to the value for the AID element in Table 8-54.

The Length field is set to 2.

The AID field is defined in 8.4.1.8.

8.4.2.167 Quiet Channel element

The Quiet Channel element is used to indicate that the secondary 80 MHz channel of a VHT BSS is to be quieted during a quiet interval indicated by either a Quiet element (see 8.4.2.25) or the Quiet Channel element if its AP Quiet Mode field is equal to 1. Furthermore, the Quiet Channel element indicates the conditions under which the primary 80 MHz channel of the VHT BSS may be used during the quiet interval.

The Quiet Channel element may be included in Beacon frames, as described in 8.3.3.2, and Probe Response frames, as described in 8.3.3.10. The use of Quiet Channel elements is described in 10.9.3.

The format of the Quiet Channel element is shown in Figure 8-401cb.

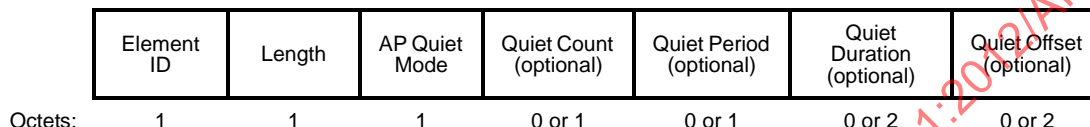

Figure 8-401cb—Quiet Channel element format

The Element ID field is defined in Table 8-54.

The Length field specifies the number of octets in the element following the Length field.

The AP Quiet Mode field specifies STA behavior during the quiet intervals. When communications to the AP are allowed within the primary 80 MHz channel of the BSS, then the AP Quiet Mode field is set to 1. Otherwise, the AP Quiet Mode field is set to 0.

If the AP Quiet Mode field is 1, then the Quiet Count field, Quiet Period field, Quiet Duration field, and Quiet Offset field are present in the Quiet Channel element; otherwise, these fields are not present in the Quiet Channel element.

The Quiet Count field, Quiet Period field, Quiet Duration field, and Quiet Offset field have the same definition as described in 8.4.2.25.

8.4.2.168 Operating Mode Notification element

The Operating Mode Notification element is used to notify STAs that the transmitting STA is changing its operating channel width, the maximum number of spatial streams it can receive, or both. The format of the Operating Mode Notification element is defined in Figure 8-401cc.

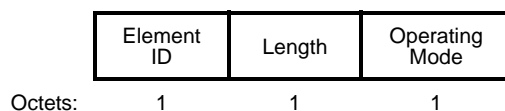

Figure 8-401cc—Operating Mode Notification element

The Element ID field is set to the value for the Operating Mode Notification element in Table 8-54.

The Length field is set to 1.

The Operating Mode field is defined in 8.4.1.50.

8.5 Action frame format details

8.5.2 Spectrum management Action frames

8.5.2.6 Channel Switch Announcement frame format

Change Figure 8-436 as follows:

					Optional	Zero or more	
	Category	Spectrum Management Action	Channel Switch Announcement element	Secondary Channel Offset element	Mesh Channel Switch Parameters element	Wide Bandwidth Channel Switch element	New VHT Transmit Power Envelope element
Octets:	1	1	5	3	6	0 or 5	variable

Figure 8-436—Channel Switch Announcement frame Action field format

Change the fifth and sixth paragraphs of 8.5.2.6, and insert new seventh and eighth paragraphs as follows:

The Secondary Channel Offset element is defined in 8.4.2.22. This element is present when switching to a 40 MHz or wider channel. It may be present when switching to a 20 MHz channel (in which case the ~~secondary channel offset~~ Secondary Channel Offset field is set to SCN).

The Mesh Channel Switch Parameters element is defined in 8.4.2.105. This element is present when a mesh STA performs an MBSS channel switch. ~~Otherwise, the Mesh Channel Switch Parameters element is not present included for channel switch other than MBSS.~~

The Wide Bandwidth Channel Switch element is defined in 8.4.2.163. This information element is present when switching to a channel width wider than 40 MHz.

Each New VHT Transmit Power Envelope element that is present is defined to have the same format as the VHT Transmit Power Envelope element (see 8.4.2.164) and includes a distinct value of the Local Maximum Transmit Power Unit Interpretation subfield. If present, the New VHT Transmit Power Envelope element indicates the local maximum transmit powers for the BSS for the indicated bandwidths with an indicated unit interpretation after channel switching (see 10.39.1).

8.5.4 DLS Action frame details

8.5.4.2 DLS Request frame format

Insert the following rows into Table 8-199 in numeric order:

Table 8-199—DLS Request frame Action field format

Order	Information	Notes
10	AID	The AID element containing the AID of the STA sending the frame is present if dot11VHTOptionImplemented is true.
11	VHT Capabilities	The VHT Capabilities element is present if the dot11VHTOptionImplemented is true.

8.5.4.3 DLS Response frame format

Insert the following rows into Table 8-200 in numeric order:

Table 8-200—DLS Response frame Action field format

Order	Information	Notes
10	AID	The AID element containing the AID of the STA sending the frame is present if dot11VHTOptionImplemented is true.
11	VHT Capabilities	The VHT Capabilities element is present if the dot11VHTOptionImplemented is true.

8.5.8 Public Action details

8.5.8.3 Measurement Pilot frame format

Change the eighth and ninth paragraphs of 8.5.8.3 (including combining them into one paragraph), and insert a new ninth paragraph as follows:

If the Wide Bandwidth Channel Switch element is not included, the Operating Class field indicates the operating class value for the operating channel. The Country, Operating Class, and Channel Number fields together specify the channel frequency and spacing for the operating channel. Valid values of Operating Class operating classes are shown listed in Annex E, excluding Operating Classes that encompass a primary channel but do not identify the location of the primary channel. The Channel Number field indicates the operating channel. Channel Number is defined within an Operating Class operating class as shown in Annex E.

If the Wide Bandwidth Channel Switch subelement is included, the fields in the Wide Bandwidth Channel Switch subelement indicate the operating channel, and the Operating Class and Channel Number together specify the primary channel and primary 40 MHz channel within the channel identified by the Wide Bandwidth Channel Switch subelement.

8.5.8.7 Extended Channel Switch Announcement frame format

Change Figure 8-449 as shown:

							<u>Zero or one</u>	<u>Zero or one</u>	<u>Zero or more</u>
Category	Public Action	Channel Switch Mode	New Operating Class	New Channel Number	Channel Switch Count	Mesh Channel Switch Parameters element	<u>New Country element</u>	<u>Wide Bandwidth Channel Switch element</u>	<u>New VHT Transmit Power Envelope element</u>
Octets:	1	1	1	1	1	6	variable	variable	variable

Figure 8-449—Extended Channel Switch Announcement frame Action field format

Insert the following paragraphs at the end of 8.5.8.7:

The New Country element is present when an AP or mesh STA performs extended channel switching to a new Country, new Operating Class Table, or a changed set of operating classes relative to the contents of the Country element sent in the Beacon; otherwise, this element is not present. The format of the New Country element is defined to be the same as the format of the Country element (see 8.4.2.10), except that no Subband Triplet fields are present in the New Country element. The Country String field in the New Country element indicates the Country and Operating Class Table of the BSS after extended channel switching and Operating Triplet fields within the New Country element indicate the operating classes of the BSS after extended channel switching (see 10.39.1).

This Wide Bandwidth Channel Switch element is present when extended channel switching to a channel width wider than 40 MHz; otherwise, this element is not present. The Wide Bandwidth Channel Switch element is defined in 8.4.2.163. The Wide Bandwidth Channel Switch element indicates the BSS operating channel width after extended channel switching (see 10.39.1).

Each New VHT Transmit Power Envelope element that is present is defined to have the same format as the VHT Transmit Power Envelope element (see 8.4.2.164) and includes a distinct value of the Local Maximum Transmit Power Unit Interpretation subfield. If present, the New VHT Transmit Power Envelope element indicates the maximum transmit powers for the BSS for the indicated bandwidths with an indicated unit interpretation after extended channel switching (see 10.39.1).

8.5.8.16 TDLS Discovery Response frame format

Insert the following row into Table 8-220 in numeric order:

Table 8-220—Information for TDLS Discovery Response frame

Order	Information	Notes
17	VHT Capabilities	VHT Capabilities element (optional). The VHT Capabilities element is present if the dot11VHTOptionImplemented is true. The VHT Capabilities element is defined in 8.4.2.160.

8.5.13 TDLS Action frame details**8.5.13.2 TDLS Setup Request Action field format**

Insert the following rows into Table 8-239 in numeric order:

Table 8-239—Information for TDLS Setup Request frame

Order	Information	Notes
19	AID	The AID element containing the AID of the STA sending the frame is present if dot11VHTOptionImplemented is true.
20	VHT Capabilities	The VHT Capabilities element is present if the dot11VHTOptionImplemented is true.

8.5.13.3 TDLS Setup Response Action field format

Insert the following rows into Table 8-240 in numeric order:

Table 8-240—Information for TDLS Setup Response frame

Order	Information	Notes
20	AID	The AID element containing the AID of the STA sending the frame is present if dot11VHTOptionImplemented is true.
21	VHT Capabilities	The VHT Capabilities element is present if the dot11VHTOptionImplemented is true.
22	Operating Mode Notification	The Operating Mode Notification element is optionally present if the TDLS Setup Request frame contained an Extended Capabilities element with the Operating Mode Notification field is equal to 1.

8.5.13.4 TDLS Setup Confirm Action field format

Insert the following rows into Table 8-241 in numeric order:

Table 8-241—Information for TDLS Setup Confirm frame

Order	Information	Notes
11	VHT Operation	VHT Operation element (optional). The VHT Operation element is present if the dot11VHTOptionImplemented is true, the TDLS Setup Response frame contained a VHT Capabilities element, the status code is 0 (Successful), and the TDLS direct link is not established in 2.4 GHz band. The VHT Operation element is defined in 8.4.2.160.
12	Operating Mode Notification	The Operating Mode Notification element is optionally present if the TDLS Setup Request frame contained an Extended Capabilities element with the Operating Mode Notification field is equal to 1.

8.5.13.7 TDLS Channel Switch Request Action field format

Insert the following rows into Table 8-244 in numeric order:

Table 8-244—Information for TDLS Channel Switch Request frame

Order	Information	Notes
8	Wide Bandwidth Channel Switch	Wide Bandwidth Channel Switch element (optional). The Wide Bandwidth Channel Switch element is included when a switch to an 80 MHz, 160 MHz, or 80+80 MHz direct link is indicated. See 8.4.2.163.
9	Country	Country element (optional). The Country element is included to change operating classes when a switch to a direct link is indicated. The Country element indicates the same country as the BSS and includes zero Subband Triplet fields.
10	VHT Transmit Power Envelope	VHT Transmit Power Envelope element (zero or more). Each VHT Transmit Power Envelope element that is present includes a distinct value of the Local Maximum Transmit Power Unit Interpretation subfield. If present, the New VHT Transmit Power Envelope element indicates the maximum transmit powers for the direct link for the indicated bandwidths with an indicated unit interpretation after a switch to a direct link (see 10.22.6.4.1).

8.5.14 WNM Action fields**8.5.14.24 Channel Usage Response frame format**

Change Figure 8-495 as shown:

	Category	Action	Dialog Token	Channel Usage Elements	Country String	Power Constraint Element (optional)	EDCA Parameter Set Element (optional)	VHT Transmit Power Envelope element (optional)
Octets:	1	1	1	variable	3	0 or 3	0 or 20	variable

Figure 8-495—Channel Usage Response frame format

Insert the following paragraph at the end of 8.5.14.24:

The VHT Transmit Power Envelope element conveys the local maximum transmit power for various transmission bandwidths. The format of the VHT Transmit Power Envelope element is shown in Figure 8-401bx.

8.5.16 Self-protected Action frame details**8.5.16.2 Mesh Peering Open frame format****8.5.16.2.2 Mesh Peering Open frame details**

Insert the following rows into Table 8-262 in numeric order:

Table 8-262—Mesh Peering Open frame Action field format

Order	Information	Notes
19	VHT Capabilities	The VHT Capabilities element is present when dot11VHTOptionImplemented is true.
20	VHT Operation	The VHT Operation element is present when dot11VHTOptionImplemented is true.
21	Operating Mode Notification	The Operating Mode Notification element is optionally present if dot11OperatingModeNotificationImplemented is true.

8.5.16.3 Mesh Peering Confirm frame format**8.5.16.3.2 Mesh Peering Confirm frame details**

Insert the following rows into Table 8-263 in numeric order:

Table 8-263—Mesh Peering Confirm frame Action field format

Order	Information	Notes
15	VHT Capabilities	The VHT Capabilities element is present when dot11VHTOptionImplemented is true.
16	VHT Operation	The VHT Operation element is present when dot11VHTOptionImplemented is true.
17	Operating Mode Notification	The Operating Mode Notification element is optionally present if dot11OperatingModeNotificationImplemented is true.

Insert the following subclauses, 8.5.23 to 8.5.23.4 (including Table 8-281ah to Table 8-281ak), after 8.5.22.3:

8.5.23 VHT Action frame details**8.5.23.1 VHT Action field**

Several Action frame formats are defined to support VHT functionality. A VHT Action field, in the octet immediately after the Category field, differentiates the VHT Action frame formats. The VHT Action field values associated with each frame format within the VHT category are defined in Table 8-281ah.

Table 8-281ah—VHT Action field values

Value	Meaning	Time Priority
0	VHT Compressed Beamforming	Yes
1	Group ID Management	No
2	Operating Mode Notification	No
3–255	Reserved	

8.5.23.2 VHT Compressed Beamforming frame format

The VHT Compressed Beamforming frame is an Action No Ack frame of category VHT. The Action field of a VHT Compressed Beamforming frame contains the information shown in Table 8-281ai.

Table 8-281ai—VHT Compressed Beamforming frame Action field format

Order	Information
1	Category
2	VHT Action
3	VHT MIMO Control (see 8.4.1.47)
4	VHT Compressed Beamforming Report (see 8.4.1.48)
5	MU Exclusive Beamforming Report (see 8.4.1.49)

The Category field is set to the value for VHT, specified in Table 8-38.

The VHT Action field is set to the value for VHT Compressed Beamforming, specified in Table 8-281ah.

The VHT MIMO Control field is always present in the frame. The presence and contents of the VHT Compressed Beamforming Report field and the MU Exclusive Beamforming Report field are dependent on the values of the Feedback Type, Remaining Feedback Segments, and First Feedback Segment subfields of the VHT MIMO Control field (see 8.4.1.47, 8.4.1.48, 8.4.1.49, and 9.31.5).

No vendor-specific elements are present in a VHT Compressed Beamforming frame.

8.5.23.3 Group ID Management frame format

The Group ID Management frame is an Action frame of category VHT. It is transmitted by the AP to assign or change the user position of a STA for one or more group IDs. The Action field of a Group ID Management frame contains the information shown in Table 8-281aj.

Table 8-281aj—Group ID Management frame Action field format

Order	Information
1	Category
2	VHT Action
3	Membership Status Array (see 8.4.1.51)
4	User Position Array (see 8.4.1.52)

The Category field is set to the value for VHT, specified in Table 8-38.

The VHT Action field is set to the value for Group ID Management, specified in Table 8-281ah.

8.5.23.4 Operating Mode Notification frame format

The Operating Mode Notification frame is an Action frame of category VHT. It is used to notify STAs that the transmitting STA is changing its operating channel width, the maximum number of spatial streams it can receive, or both.

The Action field of the Operating Mode Notification frame contains the information shown in Table 8-281ak.

Table 8-281ak—Operating Mode Notification frame Action field format

Order	Information
1	Category
2	VHT Action
3	Operating Mode (see 8.4.1.50)

The Category field is set to the value for VHT, specified in Table 8-38.

The VHT Action field is set to the value for Operating Mode Notification, specified in Table 8-281ah.

8.6 Aggregate MPDU (A-MPDU)

8.6.1 A-MPDU format

Change 8.6.1 as follows:

An A-MPDU consists of a sequence of one or more A-MPDU subframes and 0 to 3 octets of EOF pad, as shown in Figure 8-503.

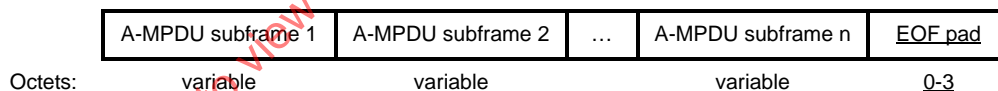

Figure 8-503—A-MPDU format

The structure of the A-MPDU subframe is shown in Figure 8-504. Each A-MPDU subframe consists of an MPDU delimiter optionally followed by an MPDU. Each nonfinal A-MPDU subframe in an A-MPDU has Except when an A-MPDU subframe is the last one in an A-MPDU, padding pad octets are appended to make each A-MPDU the subframe a multiple of 4 octets in length. In a VHT PPDU, the final A-MPDU subframe is padded to the last octet of the PSDU or to a multiple of 4 octets in length, whichever comes first (see 9.12.6). In an HT PPDU, the final A-MPDU subframe is not padded. In a VHT PPDU, the number of EOF pad octets is determined as described in 9.12.6. In an HT PPDU, the EOF Pad field is not present.

An A-MPDU pre-EOF padding is

- The portion of the A-MPDU up to but excluding the first A-MPDU subframe with 0 in the MPDU Length field and 1 in the EOF field and also excluding any subframe padding in the last subframe, or
- The portion of the A-MPDU up to and including the last A-MPDU subframe if no A-MPDU subframes with 0 in the MPDU Length field and 1 in the EOF field are present, but excluding any subframe padding in the last subframe.

NOTE—A-MPDU pre-EOF padding includes any A-MPDU subframes with 0 in the MPDU Length field and 0 in the EOF field inserted in order to meet the minimum MPDU start spacing requirement.

The A-MPDU maximum length for a non-DMG STA of an A-MPDU in an HT PPDU is 65 535 octets. The A-MPDU maximum length for a DMG STA of an A-MPDU in a DMG PPDU is 262 143 octets. The maximum length of an A-MPDU pre-EOF padding in a VHT PPDU is 1 048 575 octets. The length of an A-MPDU addressed to a particular STA may be further constrained as described in 9.12.2.

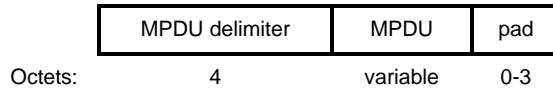

Figure 8-504—A-MPDU subframe format

The MPDU delimiter is 4 octets in length. The structure of the MPDU delimiter when transmitted by a non-DMG STA is defined in Figure 8-505. The structure of the MPDU Delimiter field when transmitted by a DMG STA is shown in Figure 8-505a.

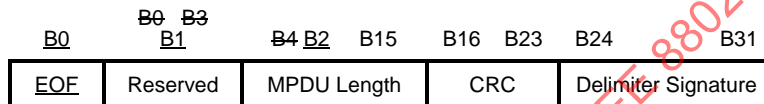

Figure 8-505—MPDU delimiter (non-DMG)

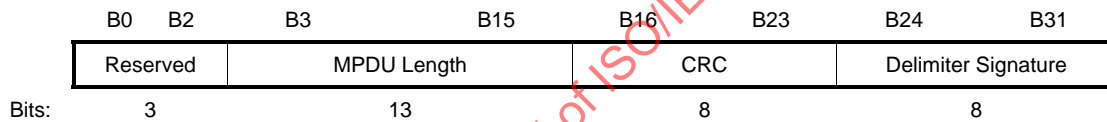

Figure 8-505a—MPDU delimiter (DMG)

The fields of the MPDU delimiter when transmitted by a non-DMG STA are defined in Table 8-282. The fields of the MPDU delimiter when transmitted by a DMG STA are defined in Table 8-282a.

Table 8-282—MPDU delimiter fields

Field	Size (bits)	Description
EOF	1	End of frame indication. Set to 1 in an A-MPDU subframe that has 0 in the MPDU Length field and that is used to pad the A-MPDU in a VHT PPDU as described in 9.12.6. Set to 1 in the MPDU delimiter of a VHT single MPDU as described in 9.12.7. Set to 0 otherwise.
Reserved	41	
MPDU Length	4214	Length of the MPDU in octets. Set to 0 if no MPDU is present. An A-MPDU subframe with 0 in the MPDU Length field is used as defined in 9.12.3 to meet the minimum MPDU start spacing requirement and also to pad the A-MPDU to fill the available octets in a VHT PPDU as defined in 9.12.6.
CRC	8	8-bit CRC of the preceding 16 bits
Delimiter Signature	8	Pattern that may be used to detect an MPDU delimiter when scanning for an MPDU delimiter. The unique pattern is set to the value 0x4E (see NOTE below). NOTE—As the Delimiter Signature field was created by the IEEE 802.11 Task Group n, it chose the ASCII value for the character 'N' as the unique pattern.
NOTE—The ASCII value of the character 'N' was chosen as the unique pattern for the value in the Delimiter Signature field.		

Table 8-282a—MPDU delimiter fields (DMG)

MPDU Delimiter field	Size (bits)	Description
Reserved	3	
MPDU length	13	Length of MPDU in octets
CRC	8	8-bit CRC on preceding 16 bits
Delimiter Signature	8	Pattern that can be used to detect an MPDU delimiter when scanning for a delimiter. The unique pattern is set to the value 0x4E.

The format of the MPDU Length field is shown in Figure 8-505a1. The MPDU Length Low subfield contains the 12 low order bits of the MPDU length. In a VHT PPDU, the MPDU Length High subfield contains the two high order bits of the MPDU length. In an HT PPDU, the MPDU Length High subfield is reserved.

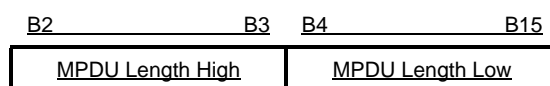
**Figure 8-505a1—MPDU Length field**

The MPDU length value is derived from the MPDU Length field subfields as follows:

$$L_{MPDU} = \begin{cases} L_{low} + L_{high} \times 4096, & \text{VHT PPDU} \\ L_{low}, & \text{HT PPDU} \end{cases} \quad (8-4)$$

where

L_{low} is the value of the MPDU Length Low subfield

L_{high} is the value of the MPDU Length High subfield

NOTE—The format of the MPDU Length field maintains a common encoding structure for both VHT and HT PPDU. For HT PPDU, only the MPDU Length Low subfield is used, while for VHT PPDU, both subfields are used.

The purpose of the MPDU delimiter is to locate the MPDUs within the A-MPDU so that the structure of the A-MPDU can usually be recovered when one or more MPDU delimiters are received with errors. See S.2 for a description of a deaggregation algorithm.

~~A delimiter with MPDU length of 0 is valid. This value is used as defined in 9.12.3 to meet the minimum MPDU start spacing requirement.~~

8.6.3 A-MPDU contents

Change 8.6.3 as follows:

In a non-DMG PPDU, an A-MPDU is a sequence of A-MPDU subframes carried in a single PPDU with one of the following combinations of RXVECTOR or TXVECTOR parameter values:

- The FORMAT parameter set to VHT
- The FORMAT parameter set to HT MF or HT GF and the AGGREGATION parameter set to 1

In a DMG PPDU, an A-MPDU is a sequence of MPDUs carried in a single PPDU with the TXVECTOR/RXVECTOR AGGREGATION parameter set to 1.

All the MPDUs within an A-MPDU are addressed to the same RA. All QoS data frames within an A-MPDU that have a TID for which an HT-immediate Block Ack agreement exists have the same value for the Ack Policy subfield of the QoS Control field.

All protected MPDUs within an A-MPDU have the same Key ID.

The Duration/ID fields in the MAC headers of all MPDUs in an A-MPDU carry the same value.

An A-MPDU is transmitted in one of the contexts specified in Table 8-283 as defined by the description in the “Definition of context” column, independently of whether the A-MPDU is contained in a VHT MU PPDU or an SU PPDU. Ordering of MPDUs within an A-MPDU is not constrained, except where noted in these tables. See 9.12.1.

A VHT MU PPDU does not carry more than one A-MPDU that contains one or more MPDUs soliciting an immediate response.

NOTE 1—The TIDs present in a data enabled A-MPDU context are also constrained by the channel access rules (for a TXOP holder, see 9.19.2 and 9.19.3) and the RD response rules (for an RD responder, see 9.24.4). This is not shown in these tables.

NOTE 2—~~MPDUs carried in an A-MPDU are limited to a maximum length of 4095 octets.~~ If a STA supports A-MSDUs of 7935 octets (indicated by the Maximum A-MSDU Length field in the HT Capabilities element), A-MSDUs transmitted by that STA within an A-MPDU carried in a PPDU with FORMAT HT MF or HT GF are constrained so that the length of the QoS data MPDU carrying the A-MSDU is no more than 4095 octets. The 4095-octet MPDU length limit does not apply to A-MPDUs carried in VHT or DMG PPDUs. The use of A-MSDU within A-MPDU might be further constrained as described in 8.4.1.14 through the operation of the A-MSDU Supported field.

Table 8-283—A-MPDU Contexts

Name of Context	Definition of Context	Table defining permitted contents
Data Enabled Immediate Response	The A-MPDU is transmitted outside a PSMP sequence by a TXOP holder or an RD responder including potential immediate responses.	Table 8-284
Data Enabled No Immediate Response	The A-MPDU is transmitted outside a PSMP sequence by a TXOP holder that does not include or solicit an immediate response. See NOTE.	Table 8-285
PSMP	The A-MPDU is transmitted within a PSMP sequence.	Table 8-286
Control Response	The A-MPDU is transmitted by a STA that is neither a TXOP holder nor an RD responder that also needs to transmit one of the following immediate response frames: Ack BlockAck with a TID for which an HT-immediate Block Ack agreement exists	Table 8-287
<u>VHT single MPDU context</u>	<u>The A-MPDU is transmitted within a VHT PPDU and contains a VHT single MPDU.</u>	<u>Table 8-288</u>
NOTE—This context includes cases when no response is generated or when a response is generated later by the operation of the delayed Block Ack rules.		

Table 8-284, Table 8-285, Table 8-286, and Table 8-287 remain unchanged.

Table 8-288—A-MPDU contents in the VHT single MPDU context

<u>MPDU</u>	<u>Conditions</u>
<u>Any MPDU</u>	<u>A VHT single MPDU.</u>

9. MAC sublayer functional description

9.2 MAC architecture

9.2.1 General

Change the first paragraph of 9.2.1 as follows:

The MAC architecture is shown in Figure 9-1. When operating with any of the Clause 14 through Clause 20 PHYs or the Clause 22 PHY, the MAC provides the HCF, including the PCF, through the services of the DCF. In a non-DMG QoS STA implementation, both DCF and HCF are present. In a non-DMG non-QoS STA implementation, only DCF is present. PCF is optional in all non-DMG STAs.

Replace Figure 9-1 with the following:

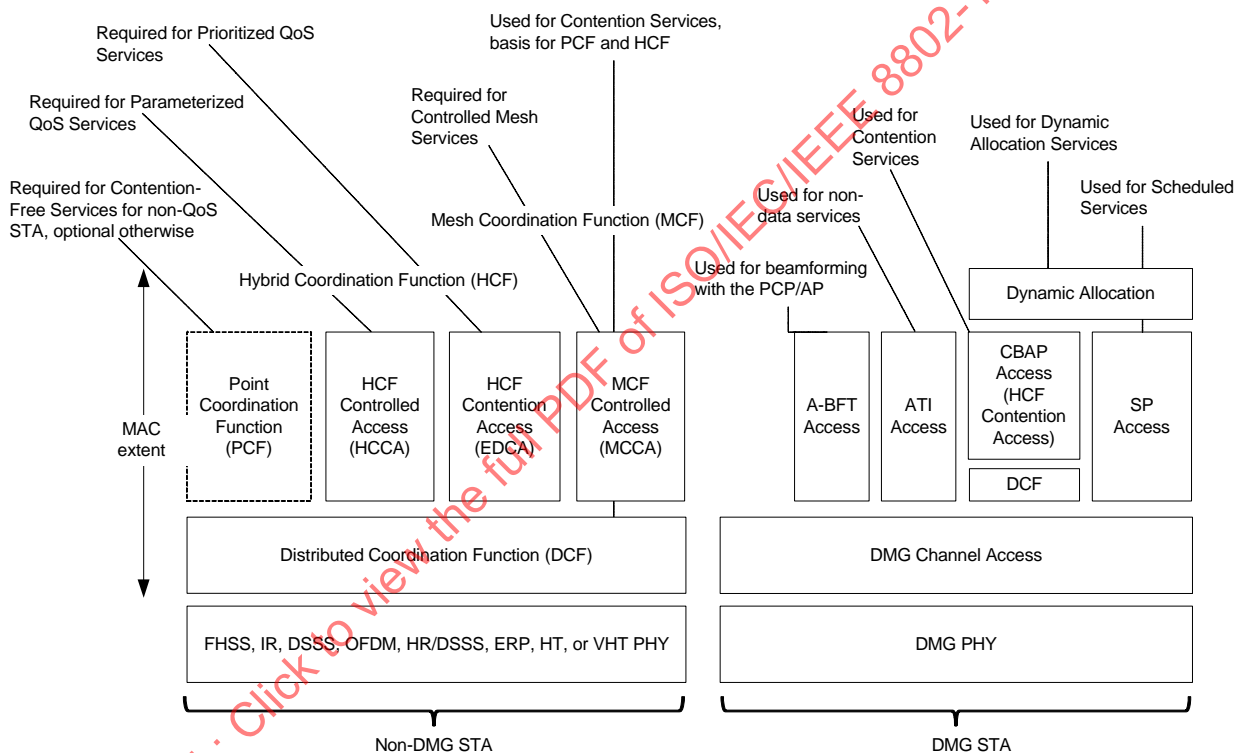

Figure 9-1—MAC architecture

9.2.4 Hybrid coordination function (HCF)

9.2.4.1 General

Change the last paragraph of 9.2.4.1 as follows:

Time priority management frames are transmitted outside of the normal MAC queuing process as per individually described transmission rules. Frames listed in Table 8-229 and Table 8-281ah with a value of “Yes” in the “Time priority” column are time priority management frames. No other frames are time priority management frames.

9.2.4.2 HCF contention-based channel access (EDCA)

Change the seventh paragraph of 9.2.4.2 as follows:

If dot11QMFActivated is false or not present for a QoS STA, a QoS STA should send individually addressed Management frames that are addressed to a non-QoS STA using the access category AC_BE and shall send all other management frames using the access category AC_VO, whether or not it is associated with a BSS or there is a QoS facility in the BSS. If dot11QMFActivated is false or not present for a QoS STA, a QoS STA that does not send individually addressed Management frames that are addressed to a non-QoS STA using the access category AC_BE shall send them using the access category AC_VO. Management frames are exempted from any and all restrictions on transmissions arising from admission control procedures. If dot11QMFActivated is true for a STA, the STA shall send management frames as described in 10.25 (Quality-of-Service management frame). BlockAckReq and BlockAck frames shall be sent using the same access category as the corresponding QoS data frames. PS-Poll frames shall be sent using the access category AC_BE (to reduce the likelihood of collision following a Beacon frame) and are exempted from any and all restrictions on transmissions arising from admission control procedures. When the first frame in a frame exchange sequence is an RTS or CTS frame, the RTS or CTS frame shall be transmitted using the access category of the corresponding QoS Data/QoS Null frame(s) or AC_VO for management frames. Control Wrapper frames shall be sent using the access category that would apply to the carried control frame. A beamformer may send a VHT NDP Announcement frame or Beamforming Report Poll frame using any access category and without being restricted by admission control procedures.

9.2.7 Fragmentation/defragmentation overview

Change the second paragraph of 9.2.7 as follows:

An MSDU transmitted under HT-immediate or HT-delayed Block Ack agreement shall not be fragmented even if its length exceeds dot11FragmentationThreshold. An MSDU or MMPDU transmitted within an A-MPDU that does not contain a VHT single MPDU (see 9.12.7) shall not be fragmented even if its length exceeds dot11FragmentationThreshold. Group addressed MSDUs or MMPDUs shall not be fragmented even if their length exceeds dot11FragmentationThreshold.

Change the third and fourth paragraphs of 9.2.7 (including combining them into one paragraph) as follows:

Except as described below, when an individually addressed MSDU is received from the LLC or an individually addressed MMPDU is received from the MLME that would result in an MPDU of length greater than dot11FragmentationThreshold, the MSDU or MMPDU shall be fragmented. ~~Except as described below, when an individually addressed MMPDU received from the MLME would result in an MPDU of length greater than dot11FragmentationThreshold, the MMPDU shall be fragmented.~~ The exception applies when an MSDU is transmitted using an HT-immediate or HT-delayed Block Ack agreement or when the MSDU or MMPDU is carried in an A-MPDU that does not contain a VHT single MPDU, in which case the MSDU or MMPDU is transmitted without fragmentation. Each fragment is a frame no longer than dot11FragmentationThreshold, if security encapsulation is not invoked for the MPDU. If security encapsulation is active for the MPDU, then the fragments shall be expanded by the encapsulation overhead and this may result in a fragment larger than dot11FragmentationThreshold. It is possible that any fragment may be a frame smaller than dot11FragmentationThreshold. An illustration of fragmentation is shown in Figure 9-2.

9.3 DCF

9.3.1 General

Change the eighth paragraph of 9.3.1 as follows:

The RTS/CTS exchange also performs both a type of fast collision inference and a transmission path check. If the return CTS is not detected by the STA originating the RTS, the originating STA may repeat the process (after observing the other medium-use rules) more quickly than if the long data frame had been transmitted and a return ACK frame had not been detected. An RTS/CTS exchange by VHT STAs also performs fast collision inference on the secondary 20 MHz channel, secondary 40 MHz channel, and secondary 80 MHz channel and helps the VHT STA transmitting the RTS to determine the available bandwidth at the responder.

Change the 12th paragraph of 9.3.1 as follows:

All STAs that are members of a BSS are able to receive and transmit at all the data rates in the BSSBasicRateSet parameter of the MLME-START.request primitive or BSSBasicRateSet parameter of the BSSDescription representing the SelectedBSS parameter of the MLME-JOIN.request primitive; see 6.3.4.2.4 and 6.3.11.2.4. All HT STAs and DMG STAs that are members of a BSS are able to receive and transmit using all the MCSs in the BSSBasicMCSSet parameter of the MLME-START.request primitive or BSSBasicMCSSet parameter of the BSSDescription representing the SelectedBSS parameter of the MLME-JOIN.request primitive; see 6.3.4.2.4 and 6.3.11.2.4. All VHT STAs that are members of a BSS are able to receive and transmit using all the <VHT-MCS, NSS> tuples in the BSS basic VHT-MCS and NSS set (see 10.39.7) except as constrained by the rules of 9.7.11. To support the proper operation of the RTS/CTS by non-DMG STAs, RTS/DMG CTS by DMG STAs, and the virtual CS mechanism, all non-DMG STAs shall be able to interpret control frames with the Subtype field set equal to RTS or CTS, and all DMG STAs shall be able to interpret control frames with the Subtype field set equal to RTS or DMG CTS.

9.3.2 Procedures common to both DCF and EDCAF

9.3.2.3 IFS

9.3.2.3.2 RIFS

Insert the following paragraph at the beginning of 9.3.2.3.2:

The use of RIFS by non-DMG STAs is obsolete, and support for such use might be subject to removal in a future revision of the standard. A VHT STA shall not transmit frames separated by a RIFS.

9.3.2.3.4 PIFS

Change the second paragraph of 9.3.2.3.4 as follows:

The PIFS may be used as described in the following list and shall not be used otherwise:

- A STA operating under the PCF as described in 9.4
- A STA transmitting a Channel Switch Announcement frame as described in 10.9
- A STA transmitting a TIM frame as described in 10.2.1.17
- An HC starting a CFP or a TXOP as described in 9.19.3.2.3
- An HC or a non-AP QoS STA that is a polled TXOP holder recovering from the absence of an expected reception in a CAP as described in 9.19.3.2.4

- An HT STA using dual CTS protection before transmission of the CTS2 as described in 9.3.2.7
- A TXOP holder continuing to transmit after a transmission failure as described in 9.19.2.4
- A TXOP holder transmitting an RTS with a bandwidth signaling TA within a multiple frame transmission sequence as specified in 9.19.2.4
- An RD initiator continuing to transmit using error recovery as described in 9.25.3
- An HT AP during a PSMP sequence transmitting a PSMP recovery frame as described in 9.26.1.3
- An HT STA performing clear channel assessment (CCA) in the secondary channel before transmitting a 40 MHz mask PPDU using EDCA channel access as described in 10.15.9
- An AP continuing to transmit in a GCR-Block-Ack TXOP after the failure to receive a BlockAck as described in 9.21.10
- A VHT STA performing CCA in the secondary 20 MHz, 40 MHz, and 80 MHz channels before transmitting a 40 MHz, 80 MHz, 160 MHz, or 80+80 MHz mask PPDU using EDCA channel access as described in 9.19.2.8
- A PCP/AP continuing to transmit in the AT after a transmission failure during the AT (9.33.3)
- A source DMG STA of an SP continuing to transmit after a transmission failure as described in 9.33.6.2
- An DMG STA performing EDCA access during an allocated CBAP as described in 9.33.5

Insert the following subclause, 9.3.2.5a, after 9.3.2.5:

9.3.2.5a VHT RTS procedure

A VHT STA transmitting an RTS frame carried in non-HT or non-HT duplicate format and addressed to a VHT STA shall set the TA field to a bandwidth signaling TA and shall set the TXVECTOR parameters CH_BANDWIDTH_IN_NON_HT and CH_BANDWIDTH to the same value. If the STA sending the RTS frame is capable of dynamic bandwidth operation (see 9.3.2.6), the STA shall set the TXVECTOR parameter DYN_BANDWIDTH_IN_NON_HT to Dynamic. Otherwise, the STA shall set the TXVECTOR parameter DYN_BANDWIDTH_IN_NON_HT to Static.

A VHT STA that initiates a TXOP by transmitting an RTS frame with the TA field set to a bandwidth signaling TA shall not send an RTS frame to a non-VHT STA for the duration of the TXOP.

NOTE—A non-VHT STA considers the bandwidth signaling TA as the address of the TXOP holder. If an RTS frame is sent to a non-VHT STA during a TXOP that is initiated by an RTS frame with a bandwidth signaling TA, the non-VHT STA does not recognize the RTS sender as the TXOP holder.

9.3.2.6 CTS and DMG CTS procedure

Insert the following paragraphs at the beginning of 9.3.2.6:

A STA that receives an RTS frame addressed to it considers the NAV in determining whether to respond with CTS, unless the NAV was set by a frame originating from the STA sending the RTS frame (see 9.19.2.2). In this subclause, “NAV indicates idle” means that the NAV count is 0 or that the NAV count is nonzero but the non-bandwidth signaling TA obtained from the TA field of the RTS frame matches the saved TXOP holder address.

A VHT STA that is addressed by an RTS frame in a non-HT or non-HT duplicate PPDU that has a bandwidth signaling TA and that has the RXVECTOR parameter DYN_BANDWIDTH_IN_NON_HT equal to Static behaves as follows:

- If the NAV indicates idle and CCA has been idle for all secondary channels (secondary 20 MHz channel, secondary 40 MHz channel, and secondary 80 MHz channel) in the channel width indicated

by the RTS frame's RXVECTOR parameter CH_BANDWIDTH_IN_NON_HT for a PIFS period prior to the start of the RTS frame, then the STA shall respond with a CTS frame carried in a non-HT or non-HT duplicate PDU after a SIFS period. The CTS frame's TXVECTOR parameters CH_BANDWIDTH and CH_BANDWIDTH_IN_NON_HT shall be set to the same value as the RTS frame's RXVECTOR parameter CH_BANDWIDTH_IN_NON_HT.

- Otherwise, the STA shall not respond with a CTS frame.

A VHT STA that is addressed by an RTS frame in a non-HT or non-HT duplicate PDU that has a bandwidth signaling TA and that has the RXVECTOR parameter DYN_BANDWIDTH_IN_NON_HT equal to Dynamic behaves as follows:

- If the NAV indicates idle, then the STA shall respond with a CTS frame in a non-HT or non-HT duplicate PDU after a SIFS period. The CTS frame's TXVECTOR parameters CH_BANDWIDTH and CH_BANDWIDTH_IN_NON_HT may be set to any channel width for which CCA on all secondary channels has been idle for a PIFS prior to the start of the RTS frame and that is equal to or less than the channel width indicated in the RTS frame's RXVECTOR parameter CH_BANDWIDTH_IN_NON_HT.
- Otherwise, the STA shall not respond with a CTS frame.

A non-VHT STA that is addressed by an RTS frame or a VHT STA that is addressed by an RTS frame carried in a non-HT or non-HT duplicate PDU that has a non-bandwidth signaling TA or a VHT STA that is addressed by an RTS frame in a format other than non-HT or non-HT duplicate behaves as follows:

- If the NAV indicates idle, the STA shall respond with a CTS frame after a SIFS period.
- Otherwise, the STA shall not respond with a CTS frame.

Change the now fifth paragraph of 9.3.2.6 as follows:

~~A STA that is addressed by an RTS frame shall transmit a CTS frame after a SIFS period if the NAV at the STA receiving the RTS frame indicates that the medium is idle. If the NAV at the STA receiving the RTS indicates the medium is not idle, that STA shall not respond to the RTS frame. The RA field of the CTS frame shall be set to the value non-bandwidth signaling TA obtained from the TA field of the RTS frame to which this CTS frame is a response. The Duration field in the CTS frame shall be the duration field from the received RTS frame, adjusted by subtraction of aSIFSTime and the number of microseconds required to transmit the CTS frame at a data rate determined by the rules in 9.7.~~

9.3.2.7 Dual CTS protection

9.3.2.7.1 Dual CTS protection procedure

Insert the following paragraphs at the beginning of 9.3.2.7.1:

A VHT STA shall not transmit VHT PDUs in a TXOP protected by dual CTS protection.

A VHT AP shall not transmit an HT Operation element with the Dual CTS Protection field set to 1.

Insert the following subclause, 9.3.2.9a (including Figure 9-9a and Figure 9-9b), after 9.3.2.9:

9.3.2.9a MU acknowledgment procedure

The acknowledgment procedure performed by a STA that receives MPDUs that were transmitted within a VHT MU PDU is the same as the acknowledgment procedure for MPDUs that were not transmitted within a VHT MU PDU.

NOTE—All MPDUs transmitted within a VHT MU PPDU are contained within A-MPDUs, and the rules specified in 8.6.3 prevent an immediate response to more than one of the A-MPDUs.

Responses to A-MPDUs within a VHT MU PPDU that are not immediate responses to the VHT MU PPDU are transmitted in response to explicit BlockAckRequest frames by the AP. Examples of VHT MU PPDU frame exchange sequences are shown in Figure 9-9a and Figure 9-9b.

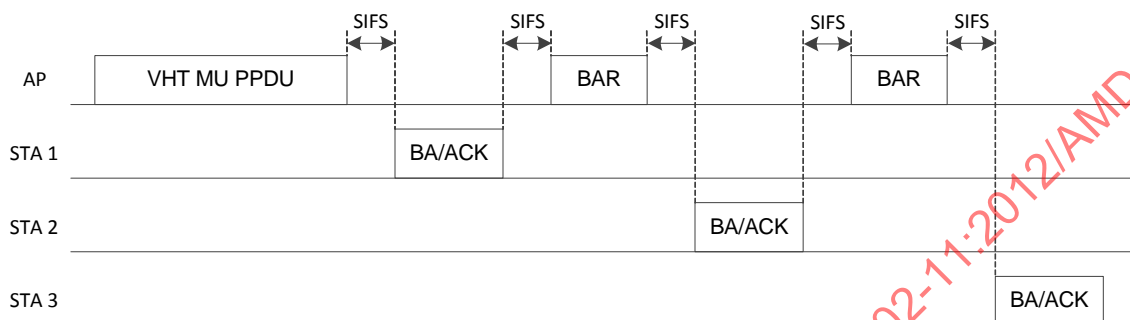

Figure 9-9a—An example of a TXOP containing a VHT MU PPDU transmission with an immediate acknowledgment to the VHT MU PPDU

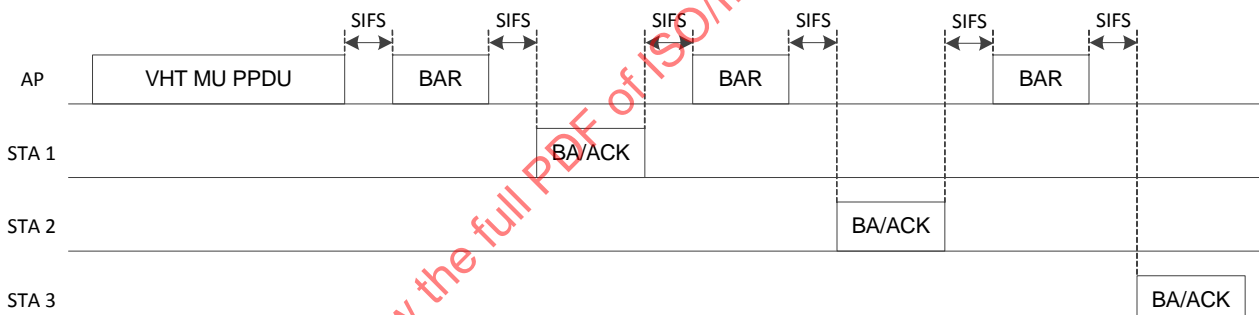

Figure 9-9b—An example of a TXOP containing a VHT MU PPDU transmission with no immediate acknowledgment to the VHT MU PPDU

Recovery within the TXOP that contains a VHT MU PPDU can be performed according to the rules of 9.19.2.4. BlockAckRequest frames related to A-MPDUs within a VHT MU PPDU can be transmitted in a TXOP separate from the one that contained the VHT MU PPDU.

NOTE 1—A BlockAck frame or an ACK frame is sent in immediate response to the BlockAckReq frame for HT-immediate or HT-delayed Block Ack, respectively. An ACK frame might be sent in immediate response to a VHT single MPDU in the VHT MU PPDU.

NOTE 2—A BlockAckRequest frame would typically not be sent to a STA in the case where the A-MPDU to the STA contained no MPDUs requiring acknowledgment. It could be sent if MPDUs in a previous A-MPDU remain unacknowledged.

9.3.4 DCF access procedure

9.3.4.4 Recovery procedures and retransmit limits

Insert the following paragraph at the end of 9.3.4.4:

An AP that fails to receive an acknowledgment after the AP transmits a frame with the More Data field set to 0 to a non-AP VHT STA that is in VHT TXOP power save mode retransmits the frame within the current TXOP under certain conditions as described in 10.2.1.19.

9.3.7 DCF timing relations

Insert the following note after the first paragraph (“The relationships between...”) of 9.3.7:

NOTE—In Figure 9-14, when transmitting a VHT PPDU, $D1$ is equal to $aRxPHYDelay$ and referenced from the end of the last symbol of a PPDU on the medium.

Change the third paragraph of 9.3.7 as follows:

$aSIFSTime$ and $aSlotTime$ are determined per PHY, $aSIFSTime$ is fixed, and $aSlotTime$ can change dynamically as $aAirPropagationTime$ changes (see 9.18.6).

When transmitting a non-VHT PPDU,

$aSIFSTime$ is: $aRxRFDelay + aRxPLCPDelay + aMACProcessingDelay + aRxTxTurnaroundTime$.

When transmitting a VHT PPDU,

$aSIFSTime$ is: $aRxPHYDelay + aMACProcessingDelay + aRxTxTurnaroundTime$.

$aSlotTime$ is: $aCCATime + aRxTxTurnaroundTime + aAirPropagationTime + aMACProcessingDelay$.

9.5 Fragmentation

Change the third paragraph of 9.5, including breaking it into three paragraphs, as follows:

A fragment is an MPDU, the payload of which carries all or a portion of an MSDU or MMPDU. When data are to be transmitted, the number of octets in the fragment (before processing by the security mechanism) shall be determined by $dot11FragmentationThreshold$ and the number of octets in the MPDU that have yet to be assigned to a fragment at the instant the fragment is constructed for the first time. Once a fragment is transmitted for the first time, its frame body content and length shall be fixed until it is successfully delivered to the immediate receiving STA.

A STA shall be capable of receiving fragments, containing all or part of an MSDU, of arbitrary length that is less than or equal to the maximum allowed MSDU size as defined in 8.2.3, plus any security encapsulation headers overhead, plus MAC header and FCS.

A STA shall be capable of receiving fragments, containing all or part of an MMPDU, of arbitrary length that is less than or equal to the minimum of

- The maximum MMPDU size as defined in 8.3.3.1, plus any security encapsulation overhead, plus MAC header and FCS
- Any maximum MPDU length advertised by the STA

9.7 Multirate support

9.7.1 Overview

Change the last paragraph of 9.7.1 as follows:

For the Clause 18, Clause 17, Clause 19, Clause 20, ~~and Clause 21,~~ and Clause 22 PHYs, the time required to transmit a frame for use in calculating the value for the Duration/ID field is determined using the PLME-TXTIME.request primitive (see 6.5.7) and the PLME-TXTIME.confirm primitive (see 6.5.8), both defined in 18.4.3, 17.3.4, 19.8.3.2, 19.8.3.3, 19.8.3.4, 20.4.3, ~~or 21.12.3,~~ or 22.4.3 depending on the PHY options. In QoS STAs, the Duration/ID field may cover multiple frames and may involve using the PLME-TXTIME.request primitive several times.

9.7.4 Basic Rate Set and Basic MCS Set for mesh STA

Change the last two paragraphs of 9.7.4 as follows:

Mesh STAs should adopt the mandatory PHY rates as the default BSSBasicRateSet to reduce the risk that a candidate peer mesh STA utilizes a different BSSBasicRateSet. If the mesh STA is also an HT STA, it should adopt the ~~MCSs of mandatory HT MCSs~~ as the default BSSBasicMCSSet. If the mesh STA is also a VHT STA, it should adopt <VHT-MCS, NSS> tuples formed from the mandatory VHT-MCSs and NSS = 1 as the default BSS basic VHT-MCS and NSS set (see 10.39.7).

Once the mesh STA establishes a mesh peering with a mesh STA, it shall not change neither the BSSBasicRateSet, nor the BSSBasicMCSSet, or BSS basic VHT-MCS and NSS set.

9.7.5 Rate selection for data and management frames

9.7.5.3 Rate selection for other group addressed data and management frames

Insert the following paragraph before the last paragraph of 9.7.5.3:

If the BSSBasicRateSet parameter is empty and the BSSBasicMCSSet parameter is empty and the BSS basic VHT-MCS and NSS set is not empty, the frame shall be transmitted in a VHT PPDU using one of the <VHT-MCS, NSS> tuples included in the BSS basic VHT-MCS and NSS set.

Change the last paragraph of 9.7.5.3 as follows:

If ~~both the BSSBasicRateSet parameter, and the BSSBasicMCSSet parameter,~~ and the BSS basic VHT-MCS and NSS set are empty (e.g., a scanning STA that is not yet associated with a BSS), the frame shall be transmitted in a non-HT PPDU using one of the mandatory PHY rates.

Insert the following subclause, 9.7.5.5a, after 9.7.5.5:

9.7.5.5a Rate selection for data frames sent within an FMS stream

Data frames sent within an FMS stream are sent at a rate negotiated during the establishment of the FMS stream. See 10.23.7.

Change 9.7.5.6 (including the subclause title) as follows:

9.7.5.6 Rate selection for other individually addressed data and management frames

A data or management frame not identified in 9.7.5.1 through ~~9.7.5.5~~ 9.7.5.5a shall be sent using any data rate, ~~or MCS, or <VHT-MCS, NSS> tuple~~ subject to the following constraints:

- A STA shall not transmit a frame using a rate or MCS that is not supported by the receiver STA or STAs, as reported in any Supported Rates element, Extended Supported Rates element, or Supported MCS Set field in management frames transmitted by the receiver STA.
- A STA shall not transmit a frame using a <VHT-MCS, NSS> tuple that is not supported by the receiver STA, as reported in any Supported VHT-MCS and NSS Set field in management frames transmitted by the receiver STA.
- If at least one Operating Mode field with the Rx NSS Type subfield equal to 0 was received from the receiver STA:
 - A STA shall not transmit a frame with the number of spatial streams greater than that indicated in the Rx NSS subfield in the most recently received Operating Mode field with the Rx NSS Type subfield equal to 0 from the receiver STA.
- If at least one Operating Mode field with the Rx NSS Type subfield equal to 1 was received from the receiver STA:
 - A STA shall not transmit an SU PPDU frame using a beamforming steering matrix with the number of spatial streams greater than that indicated in the Rx NSS subfield in the most recently received Operating Mode field with the Rx NSS Type subfield equal to 1 from the receiver STA if the beamforming steering matrix was derived from a VHT Compressed Beamforming report with Feedback Type subfield indicating MU in the VHT Compressed Beamforming frame(s).
- A STA shall not transmit a frame using a value for the CH_BANDWIDTH parameter of the TXVECTOR that is not supported by the receiver STA, ~~as reported in any HT Capabilities element or VHT Capabilities element received from the intended receiver.~~
- An HT STA that is a member of a BSS and that is not a VHT STA shall not transmit a frame using a value for the CH BANDWIDTH parameter of the TXVECTOR that is not permitted for use in the BSS, as reported in the most recently received HT Operation element with the exception transmissions on a TDLS off-channel link, which follow the rules described in 10.22.6.1 and 10.22.6.2.
- A VHT STA that is a member of a BSS shall not transmit a frame using a value for the CH BANDWIDTH parameter of the TXVECTOR that is not permitted for use in the BSS, as reported in the most recently received VHT Operation element with the following exceptions:
 - Transmissions on a TDLS off-channel link follow the rules described in 10.22.6.1 and 10.22.6.2.
 - Transmissions by a VHT STA on a TDLS link follow the rules described in 10.22.1 and 10.22.6.4.
- If at least one Operating Mode field with the Rx NSS Type subfield equal to 0 was received from the receiver STA:
 - A STA shall not transmit a frame using a value for the TXVECTOR parameter CH BANDWIDTH that is not supported by the receiver STA as reported in the most recently received Operating Mode field with the Rx NSS Type subfield equal to 0 from the receiver STA.
- A STA shall not initiate transmission of a frame at a data rate higher than the greatest rate in the OperationalRateSet, ~~or using an MCS that is not in the HTOperationalMCSSet, or using a <VHT-MCS, NSS> tuple that is not in the OperationalVHTMCS_NSSSet,~~ which are parameters of the MLME-JOIN.request primitive.

When the supported rate set of the receiving STA is not known, the transmitting STA shall transmit using a rate in the BSSBasicRateSet parameter, or an MCS in the BSSBasicMCSSet parameter, ~~or a <VHT-MCS,~~

NSS> tuple in the BSS basic VHT-MCS and NSS set, or a rate from the mandatory rate set of the attached PHY if both the BSSBasicRateSet, and the BSSBasicMCSSet, and the BSS basic VHT-MCS and NSS set are empty.

The rules in this subclause also apply to A-MPDUs that aggregate MPDUs of type Data or Management with any other types of MPDU.

9.7.6 Rate selection for control frames

9.7.6.1 General rules for rate selection for control frames

Change 9.7.6.1 as follows:

Control frames carried in an A-MPDU that does not contain a VHT single MPDU shall be sent at a rate selected from the rules defined in 9.7.5.6.

NOTE—The rules defined in 9.7.6.2 through 9.7.6.5 apply only to control frames not carried in an A-MPDU that does not contain a VHT single MPDU.

The following rules determine whether a control frame is carried in an ~~HT PPDU~~ or non-HT, HT, or VHT PPDU:

- a) A control frame shall be carried in an HT PPDU when the control frame meets any of the following conditions:
 - 1) The control frame contains an L-SIG duration value (see 9.23.5), or
 - 2) The control frame is sent using an STBC frame.
- b) A control response frame shall be carried in an HT PPDU when the control frame is a response to a frame that meets any of the following conditions:
 - 1) The frame eliciting the response included an HT variant HT Control field with the TRQ field equal to 1 and the HT NDP Announcement subfield equal to 0, and this responder set the Implicit Transmit Beamforming Receiving Capable field to 1 in its last transmitted HT Capabilities element; or
 - 2) The frame eliciting the response was an RTS frame carried in an HT PPDU; or
 - 3) The frame eliciting the response was an STBC frame, and the Dual CTS Protection field was equal to 1 in the last HT Operation element received from its AP or transmitted by the STA (see 9.3.2.7).
- c) A control frame may be carried in an HT PPDU when the control frame meets any of the following conditions:
 - 1) The control frame contains an HT variant HT Control field with the MRQ subfield equal to 1, or
 - 2) The control frame contains an HT variant HT Control field with the TRQ field equal to 1.

NOTE—~~In these cases, requirements specified in 9.27, 9.28.2, and 9.29 further constrain the choice of non-HT or HT PPDU.~~
- d) A control frame may be carried in a VHT PPDU when the control frame contains an HT Control field or is an STBC frame.
- e) A control response frame shall be carried in a VHT PPDU if the eliciting frame was an RTS frame carried in a VHT PPDU that contains an HT Control field with MRQ subfield equal to 1.
- f) Otherwise, the control frame shall be carried in a non-HT PPDU.

NOTE—In these cases, the requirements specified in 9.27, 9.28.2, and 9.29 further constrain the choice of non-HT, HT, or VHT PPDU.

If an Operating Mode field has been received from the intended receiver STA, the following constraints also apply:

- If at least one Operating Mode field with the Rx NSS Type subfield equal to 0 was received from the receiver STA:
 - A STA shall not transmit a frame with the number of spatial streams greater than that indicated in the Rx NSS subfield in the most recently received Operating Mode field with the Rx NSS Type subfield equal to 0 from the receiver STA.
- If at least one Operating Mode field with the Rx NSS Type subfield equal to 1 was received from the receiver STA:
 - A STA shall not transmit an SU PPDU frame using a beamforming steering matrix with the number of spatial streams greater than that indicated in the Rx NSS subfield in the most recently received Operating Mode field with the Rx NSS Type subfield equal to 1 from the receiver STA if the beamforming steering matrix was derived from a VHT Compressed Beamforming report with Feedback Type subfield indicating MU in the VHT Compressed Beamforming frame(s).

Selection of channel width is defined in 9.7.6.6.

A control response frame is a control frame that is transmitted as a response to the reception of a frame a SIFS time after the PPDU containing the frame that elicited the response, e.g. a CTS in response to an RTS reception, an ACK in response to a DATA reception, a BlockAck in response to a BlockAckReq reception. In some situations, the transmission of a control frame is not a control response transmission, such as when a CTS is used to initiate a TXOP.

9.7.6.2 Rate selection for control frames that initiate a TXOP

Change the first paragraph of 9.7.6.2 as follows:

This subclause describes the rate selection rules for control frames that initiate a TXOP and that are either a VHT single MPDU or not carried in an A-MPDU.

Insert the following paragraph at the end of 9.7.6.2:

When transmitting a VHT PPDU, a STA shall select a <VHT-MCS, NSS> tuple from the BSS basic VHT-MCS and NSS set when protection is required (as defined in 9.23) and shall select a <VHT-MCS, NSS> tuple from the SupportedVHTMCS_NSSSet parameter of the intended receiver when protection is not required.

9.7.6.4 Rate selection for control frames that are not control response frames

Change the first paragraph of 9.7.6.4 as follows:

This subclause describes the rate selection rules for control frames that are not control response frames, are not the frame that initiates a TXOP, are not the frame that terminates a TXOP, and are either a VHT single MPDU or not carried in an A-MPDU.

Change the fourth paragraph of 9.7.6.4 as follows:

A frame that is carried in an HT PPDU shall be transmitted by the STA using an MCS supported by the receiver STA, as reported in the Supported MCS Set field in the HT Capabilities element ~~in management frames transmitted by~~ received from that STA. When the supported ~~rate-MCS~~ set of the receiving STA or STAs is not known, the transmitting STA shall transmit using an MCS in the BSSBasicMCSSet parameter.

Insert the following paragraph at the end of 9.7.6.4:

A frame that is carried in a VHT PPDU shall be transmitted by the STA using a <VHT-MCS, NSS> tuple supported by the receiver STA. A <VHT-MCS, NSS> tuple is supported if reported as such in the Supported VHT-MCS and NSS Set field in the VHT Capabilities element received from that STA. When the Supported VHT-MCS and NSS set of the receiving STA or STAs is not known, the transmitting STA shall transmit using a <VHT-MCS, NSS> tuple in the BSS basic VHT-MCS and NSS set.

9.7.6.5 Rate selection for control response frames

9.7.6.5.1 Introduction

Change 9.7.6.5.1 as follows:

Subclauses 9.7.6.5.2 through 9.7.6.5.5 describe the rate selection rules for control response frames that are either a VHT single MPDU or not carried in an A-MPDU.

9.7.6.5.2 Selection of a rate or MCS

Change the second bullet in the dashed list of the first paragraph of 9.7.6.5.2 as follows:

- If a BlockAck frame is sent as an immediate response to either an implicit BlockAck request or to a BlockAckReq frame that was carried in an HT or VHT PPDU and the BlockAck frame is carried in a non-HT PPDU, the primary rate is defined to be the highest rate in the BSSBasicRateSet parameter that is less than or equal to the rate (or non-HT reference rate; see 9.7.9) of the previous frame. If no rate in the BSSBasicRateSet parameter meets these conditions, the primary rate is defined to be the highest mandatory rate of the attached PHY that is less than or equal to the rate (or non-HT reference rate; see 9.7.9) of the previous frame. The STA may select an alternate rate according to the rules in 9.7.6.5.4. The STA shall transmit the non-HT PPDU BlockAck control response frame at either the primary rate or the alternate rate, if one exists.

Change the fifth bullet in the dashed list of the first paragraph of 9.7.6.5.2 as follows:

- If the control response frame is carried in an HT or VHT PPDU, then it is transmitted ~~at~~ using an MCS or <VHT-MCS, NSS> tuple as determined by the procedure defined in 9.7.6.5.3.

Change the second paragraph of 9.7.6.5.2 as follows:

The modulation class of the control response frame shall be selected according to the following rules:

- If the received frame is of a modulation class other than HT or VHT and the control response frame is carried in a non-HT PPDU, the control response frame shall be transmitted using the same modulation class as the received frame. In addition, the control response frame shall be sent using the same value for the TXVECTOR parameter PREAMBLE_TYPE as the received frame.
- If the received frame is of the modulation class HT or VHT and the control response frame is carried in a non-HT PPDU, the control response frame shall be transmitted using one of the ERP-OFDM or OFDM modulation classes.
- If the control response frame is carried in an HT PPDU, the modulation class shall be HT.
- If the control response frame is carried in a VHT PPDU, the modulation class shall be VHT.

9.7.6.5.3 Control response frame MCS computation

Change 9.7.6.5.3 as follows:

If a control response frame is to be transmitted within an HT or VHT PDU, the channel width (CH_BANDWIDTH parameter of the TXVECTOR) shall be selected first according to 9.7.6.6, and then the MCS or <VHT-MCS, NSS> tuple shall be selected from a set of MCSs and <VHT-MCS, NSS> tuples called the *CandidateMCSSet* as described in this subclause.

If the frame eliciting the response was transmitted by an HT STA that is not a VHT STA, the Rx Supported MCS Set of the STA that transmitted the frame eliciting the response is determined from the its-Supported MCS Set field in the HT Capabilities element received from the STA, as follows:

- If a bit in the Rx MCS Bitmask subfield is equal to 0, the corresponding MCS is not supported.
- If a bit in the Rx MCS Bitmask subfield is equal to 1 and the integer part of the data rate (expressed in megabits per second) of the corresponding MCS is less than or equal to the rate represented by the Rx Highest Supported Data Rate subfield, then the MCS is supported by the STA on receive. If the Rx Highest Supported Data Rate subfield is equal to 0 and a bit in the Rx MCS Bitmask is equal to 1, then the corresponding MCS is supported by the STA on receive.

If the frame eliciting the response was transmitted by a VHT STA, the Rx Supported MCS Set is determined for VHT PDUs as described in 9.7.11 and for HT PDUs from the Supported MCS Set field in the HT Capabilities element received from the STA as follows:

- If a bit in the Rx MCS Bitmask subfield is equal to 0, the corresponding MCS is not supported.
- If a bit in the Rx MCS Bitmask subfield is equal to 1 and the integer part of the data rate (expressed in megabits per second) of the corresponding MCS is less than or equal to the rate represented by the Rx Highest Supported Data Rate subfield, then the MCS is supported by the STA on receive. If the Rx Highest Supported Data Rate subfield is equal to 0 and a bit in the Rx MCS Bitmask is equal to 1, then the corresponding MCS is supported by the STA on receive.

The *CandidateMCSSet* is determined using the following rules:

- If the frame eliciting the response was an STBC frame and the Dual CTS Protection bit is equal to 1, the *CandidateMCSSet* shall contain only the basic STBC MCS.
- If the frame eliciting the response had an L-SIG duration value (see 9.23.5) and initiates a TXOP, the *CandidateMCSSet* is the MCS Set consisting of the intersection of the Rx Supported MCS Set of the STA that sent the frame that is eliciting the response and the set of MCSs that the responding STA is capable of transmitting.
- If none of the above conditions is true, the *CandidateMCSSet* is the union of the BSSBasicMCSSet and the BSS basic VHT-MCS and NSS set parameter. If the frame eliciting the response was an RTS frame carried in a VHT PDU, then the *CandidateMCSSet* may additionally include the <VHT-MCS, NSS> tuple with the same MCS and number of spatial streams as the VHT PDU. If the combined BSSBasicMCSSet parameter is empty, the *CandidateMCSSet* shall consist of
 - ‡The set of mandatory HT PHY MCSs if the STA eliciting the response is an HT STA that is not a VHT STA
 - The set of mandatory HT MCSs plus the set of <VHT MCS, NSS> tuples corresponding to the mandatory VHT PHY MCSs with NSS = 1 if the STA eliciting the response is a VHT STA-

MCS values from the *CandidateMCSSet* that cannot be transmitted with the selected CH_BANDWIDTH parameter value shall be eliminated from the *CandidateMCSSet*.

The choice of a response MCS is made as follows:

- a) If the frame eliciting the response is within a non-HT PDU,

- 1) Eliminate from the CandidateMCSSet all $\langle \text{VHT-MCS}, \text{NSS} \rangle$ tuples. Moreover, eliminate all MCSs that have a data rate greater than the data rate of the received PPDU (the mapping of MCS to data rate is defined in 20.6).
 - 2) Find the highest indexed MCS from the CandidateMCSSet. The index of this MCS is the index of the MCS that is the primary MCS for the response transmission.
 - 3) If the CandidateMCSSet is empty, the primary MCS is the lowest indexed MCS of the mandatory MCSs.
- b) If the frame eliciting the response is within an HT PPDU,
- 1) Eliminate from the CandidateMCSSet all $\langle \text{VHT-MCS}, \text{NSS} \rangle$ tuples. Moreover, eliminate all MCSs that have an index that is higher than the index of the MCS of the received frame. Also eliminate all MCSs that have a number of spatial streams greater than that indicated in the Rx NSS subfield in the most recent Operating Mode field with the Rx NSS Type subfield equal to 0 from the intended receiver STA, if at least one Operating Mode field with the Rx NSS Type subfield equal to 0 was received from the intended receiver STA.
 - 2) Determine the highest number of spatial streams (N_{SS}) value of the MCSs in the CandidateMCSSet that is less than or equal to the N_{SS} value of the MCS of the received frame. Eliminate all MCSs from the CandidateMCSSet that have an N_{SS} value that is not equal to this N_{SS} value. The mapping from MCS to N_{SS} is dependent on the attached PHY. For the HT PHY, see 20.6.
 - 3) Find the highest indexed MCS of the CandidateMCSSet for which the modulation value of each stream is less than or equal to the modulation value of each stream of the MCS of the received frame and for which the coding rate value is less than or equal to the coding rate value of the MCS from the received frame. The index of this MCS is the index of the MCS that is the primary MCS for the response transmission. The mapping from MCS to modulation and coding rate is dependent on the attached PHY. For the HT PHY, see 20.6. For the purpose of comparing modulation values, the following sequence shows increasing modulation values: BPSK, QPSK, 16-QAM, 64-QAM.
 - 4) If no MCS meets the condition in step 3), remove each MCS from the CandidateMCSSet that has the highest value of N_{SS} in the CandidateMCSSet. If the resulting CandidateMCSSet is empty, then set the CandidateMCSSet to the HT PHY mandatory MCSs. Repeat step 3) using the modified CandidateMCSSet.
- c) If the frame eliciting the response is within a VHT PPDU,
- 1) Eliminate from the CandidateMCSSet all MCSs and all $\langle \text{VHT-MCS}, \text{NSS} \rangle$ tuples that meet any of the following conditions:
 - i) Have a data rate that is higher than the data rate of the $\langle \text{VHT-MCS}, \text{NSS} \rangle$ tuple of the received frame using the largest possible value of CH BANDWIDTH that is no larger than the value of CH BANDWIDTH of the received frame
 - ii) Have a number of spatial streams greater than that indicated in the Rx NSS subfield in the most recent Operating Mode field with the Rx NSS Type subfield equal to 0 from the intended receiver STA, if at least one Operating Mode field with the Rx NSS Type subfield equal to 0 was received from the intended receiver STA
 - iii) Have a number of spatial streams greater than that indicated in the Rx NSS subfield in the most recent Operating Mode field with the Rx NSS Type subfield equal to 1 from the intended receiver STA if at least one Operating Mode field with the Rx NSS Type subfield equal to 1 was received from the receiver STA and the control response frame is an SU PPDU frame with a beamforming steering matrix and the beamforming steering matrix was derived from a VHT Compressed Beamforming report with Feedback Type subfield indicating MU in the VHT Compressed Beamforming frame(s)
 - 2) Determine the highest number of spatial streams (N_{SS}) value of the MCSs and $\langle \text{VHT-MCS}, \text{NSS} \rangle$ tuples in the CandidateMCSSet that is less than or equal to the N_{SS} value of the received

- frame. Eliminate all MCSs from the CandidateMCSSet that have an N_{SS} value that is not equal to this N_{SS} value. The mapping from MCS to N_{SS} is dependent on the attached PHY. For the HT PHY, see 20.6.
- 3) Find the highest rate MCS or <VHT-MCS, NSS> tuple of the CandidateMCSSet for which the modulation value of each stream is less than or equal to the modulation value of each stream of the MCS of the received frame and for which the coding rate is less than or equal to the coding rate of the MCS from the received frame. This MCS or <VHT-MCS, NSS> tuple is the primary MCS for the response transmission. The mapping from MCS or <VHT-MCS, NSS> tuple to modulation and coding rate is dependent on the attached PHY. For the HT PHY, see 20.6; for the VHT PHY, see 22.5. For the purpose of comparing modulation values, the following sequence shows increasing modulation values: BPSK, QPSK, 16-QAM, 64-QAM, 256-QAM.
 - 4) If no MCS meets the condition in step 3), remove each MCS or <VHT-MCS, NSS> tuple from the CandidateMCSSet that has the highest value of N_{SS} in the CandidateMCSSet. If the resulting CandidateMCSSet is empty, then set the CandidateMCSSet to the VHT PHY mandatory MCSs. Repeat step 3) using the modified CandidateMCSSet.

Once the primary MCS or <VHT-MCS, NSS> tuple has been selected, the STA may select an alternate MCS according to 9.7.6.5.4. The STA shall transmit the HT-PPDU control response frame using either the primary MCS or the alternate MCS, if one exists.

9.7.6.6 Channel Width selection for control frames

Change 9.7.6.6 as follows:

An HT STA that receives a frame that elicits a control frame transmission shall send the control frame response using a value for the CH_BANDWIDTH parameter that is based on the CH_BANDWIDTH parameter value of the received frame according to Table 9-3.

Table 9-3—CH_BANDWIDTH control frame response mapping

CH_BANDWIDTH RXVECTOR value	CH_BANDWIDTH TXVECTOR value
HT_CBW20	HT_CBW20 or NON_HT_CBW20
HT_CBW40	HT_CBW40 or NON_HT_CBW40
NON_HT_CBW20	HT_CBW20 or NON_HT_CBW20
NON_HT_CBW40	HT_CBW40 or NON_HT_CBW40

NOTE—This rule. The rules in this subclause, combined with the rules in 9.7.5.1 (General rules for rate selection for control frames), determines the format of control response frames.

If a VHT STA transmits to another VHT STA a control frame that is not an RTS frame or a CF-End frame, if that control frame elicits a control response frame or a VHT Compressed Beamforming frame, and

- If the control frame is transmitted in a non-HT duplicate PPDU (channel width 40 MHz or wider), the transmitting VHT STA shall set the TA field to a bandwidth signaling TA.
- If the control frame is transmitted in a non-HT PPDU (channel width 20 MHz), the transmitting VHT STA may set the TA field to a bandwidth signaling TA.

If the TA is a bandwidth signaling TA, the transmitting VHT STA shall set the TXVECTOR parameters CH_BANDWIDTH IN NON_HT and CH_BANDWIDTH to the same value.

NOTE 1—Such control frames are BlockAckReq frames, BlockAck frames in the context of HT-delayed Block Ack, PS-Poll frames, VHT NDP Announcement frames, and Beamforming Report Poll frames.

NOTE 2—Control Wrapper frames follow the rules pertaining to the carried control frame (see 9.10).

Channel width selection rules for RTS frames are described in 9.3.2.5a.

A VHT STA that transmits a CF-End frame in a non-HT duplicate PPDU (channel width 40 MHz or wider) addressed to a VHT AP shall set the Individual/Group bit in the BSSID(TA) field to 1.

A VHT STA that transmits a CF-End frame in a non-HT PPDU (channel width 20 MHz) addressed to a VHT AP may set the Individual/Group bit in the BSSID(TA) field to 1.

If the Individual/Group bit in the BSSID(TA) field of the CF-End frame is set to 1, the transmitting VHT STA shall set the TXVECTOR parameters CH BANDWIDTH IN NON HT and CH BANDWIDTH to the same value.

A STA that sends a control frame in response to a frame carried in an HT PPDU or a VHT PPDU shall set the TXVECTOR parameter CH BANDWIDTH to indicate a channel width that is the same as the channel width indicated by the RXVECTOR parameter CH BANDWIDTH of the frame eliciting the response.

A STA that sends a control frame in response to a frame carried in a non-HT or non-HT duplicate PPDU with a non-bandwidth signaling TA

- Should set the TXVECTOR parameter CH BANDWIDTH to the same value as the RXVECTOR parameter CH BANDWIDTH for the frame eliciting the response.
- Shall not set the TXVECTOR parameter CH BANDWIDTH to a value greater than the RXVECTOR parameter CH BANDWIDTH for the frame eliciting the response.

NOTE—According to this rule, a STA can respond with a 20 MHz PPDU if it receives a non-HT duplicate frame but is not able to detect the channel width occupied by the frame (whether by design or because the frame was received over a channel that is narrower than the channel on which it was transmitted).

A VHT STA that sends a control frame that is in response to a non-HT or non-HT duplicate format frame with a bandwidth signaling TA and that is not a CTS shall set the channel width indicated by the TXVECTOR parameter CH BANDWIDTH to the same value as the channel width indicated by the RXVECTOR parameter CH BANDWIDTH IN NON HT for the frame eliciting the response. The RA field of a control frame that is not a CF-End frame and that is sent in response to a control frame with a bandwidth signaling TA shall be set to a non-bandwidth signaling TA obtained from the TA field of the immediate previous control frame. For the channel width selection rules for CTS sent in response to an RTS with a bandwidth signaling TA, see 9.3.2.6.

A frame that is intended to provide protection is transmitted using a channel width selected by the rules defined in 9.23.

An HT STA that uses a non-HT duplicate frame to establish protection of its TXOP shall send any CF-End frame using a non-HT duplicate frame except during the 40 MHz phase of PCO operation. During the 40 MHz phase of PCO operation, the rules in 10.16 apply.

The TXOP holder should set the TXVECTOR parameter CH BANDWIDTH of a CF-End frame to the maximum bandwidth allowed by the rules in 9.19.2.4.

NOTE—A CF-End frame transmitted by an AP a SIFS duration after receiving a CF-End frame is considered a control response frame.

9.7.8 Modulation classes

Change 9.7.8 as follows:

In order to determine the rules for response frames given in 9.7, the following modulation classes are defined in Table 9-4. Each row defines a modulation class. Modulations described within the same row have the same modulation class, while modulations described in different rows have different modulation classes. For Clause 20 PHY transmissions, the modulation class is determined by the FORMAT and NON_HT_MODULATION parameters of the TXVECTOR/RXVECTOR. Otherwise, the modulation class is determined by the clause or subclause number defining that modulation.

Table 9-4 defines modulation classes for the rules for response frames in 9.7.

Table 9-4—Modulation classes

Modulation class	Description of modulation	Condition that selects this modulation class		
		Clause 14 to Clause 19 PHYs and Clause 21 PHY	Clause 20 PHY	Clause 22 PHY
1	Infrared (IR)	Clause 15 transmission	N/A	<u>N/A</u>
2	Frequency-hopping spread spectrum (FHSS)	Clause 14 transmission	N/A	<u>N/A</u>
3	DSSS and HR/DSSS	Clause 16 or Clause 17 transmission	FORMAT is NON_HT. NON_HT_MODULATION is ERP-DSSS or ERP-CCK.	<u>N/A</u>
4	ERP-PBCC	19.6 transmission	FORMAT is NON_HT. NON_HT_MODULATION is ERP-PBCC.	<u>N/A</u>
5	DSSS-OFDM The use of the DSSS-OFDM option is deprecated, and this option may be removed in a later revision of the standard.	19.7 transmission	FORMAT is NON_HT. NON_HT_MODULATION is DSSS-OFDM.	<u>N/A</u>
6	ERP-OFDM	19.5 transmission	FORMAT is NON_HT. NON_HT_MODULATION is ERP-OFDM.	<u>N/A</u>
7	OFDM	Clause 18 transmission	FORMAT is NON_HT. NON_HT_MODULATION is OFDM or NON_HT_DUP_OFDM.	<u>FORMAT is NON_HT. NON_HT_MODULATION is OFDM</u> or <u>NON_HT_DUP_OFDM.</u>

Table 9-4—Modulation classes (continued)

Modulation class	Description of modulation	Condition that selects this modulation class		
		Clause 14 to Clause 19 PHYs and Clause 21 PHY	Clause 20 PHY	<u>Clause 22 PHY</u>
8	HT	N/A	FORMAT is HT_MF or HT_GF.	<u>FORMAT is HT_MF or HT_GF.</u>
9	DMG Control	21.4 transmission	N/A	<u>N/A</u>
10	DMG SC	21.6 transmission	N/A	<u>N/A</u>
11	DMG OFDM	21.5 transmission	N/A	<u>N/A</u>
12	DMG low power SC	21.7 transmission	N/A	<u>N/A</u>
<u>13</u>	<u>VHT</u>	<u>N/A</u>	<u>N/A</u>	<u>FORMAT is VHT.</u>

9.7.9 Non-HT basic rate calculation

Change the first paragraph of 9.7.9 as follows (note that footnote 27 remains unchanged):

This subclause defines how to convert ~~an~~ HT-MCSs and VHT-MCSs to a non-HT basic rate for the purpose of determining the rate of the a response frame. It consists of two steps as follows:

- Use the modulation and coding rate determined from the HT MCS (defined in 20.6) or VHT-MCS (defined in 22.5) to locate a non-HT reference rate by lookup into Table 9-5.²⁷ In the case of an MCS with UEQM, the modulation of stream 1 is used.
- The non-HT basic rate is the highest rate in the BSSBasicRateSet that is less than or equal to this non-HT reference rate.

Insert the following rows at the end of Table 9-5:

Table 9-5—Non-HT reference rate

Modulation	Coding rate (R)	Non-HT reference (Mb/s)
256-QAM	3/4	54
256-QAM	5/6	54

Insert the following subclauses, 9.7.10 to 9.7.11.3 (including Table 9-5a), after 9.7.9:

9.7.10 Channel Width in non-HT and non-HT duplicate PPDUs

A non-VHT STA shall include neither the CH_BANDWIDTH_IN_NON_HT parameter nor the DYN_BANDWIDTH_IN_NON_HT parameter in either of the Clause 18 TXVECTOR or RXVECTOR. A non-VHT STA shall not set the TA field to a bandwidth signaling TA. A VHT STA shall include neither the CH_BANDWIDTH_IN_NON_HT parameter nor the DYN_BANDWIDTH_IN_NON_HT parameter in the

Clause 22 TXVECTOR of a non-HT PPDU addressed to a non-VHT STA. A VHT STA shall not set the TA field to a bandwidth signaling TA in a frame addressed to a non-VHT STA. A VHT STA that includes the DYN_BANDWIDTH_IN_NON_HT parameter in the TXVECTOR shall also include the CH_BANDWIDTH_IN_NON_HT parameter in the TXVECTOR. A VHT STA shall not include the DYN_BANDWIDTH_IN_NON_HT parameter in the TXVECTOR for transmitted frames other than RTS frames with bandwidth signaling TA and that are sent in a non-HT PPDU. A STA that transmits an RTS frame with a bandwidth signaling TA shall include the DYN_BANDWIDTH_IN_NON_HT parameter in the TXVECTOR. A VHT STA shall include both the CH_BANDWIDTH_IN_NON_HT and DYN_BANDWIDTH_IN_NON_HT parameters in the Clause 18 RXVECTOR.

A bandwidth signaling TA may be included only in non-HT and non-HT duplicate PPDUs and shall not be included otherwise. If the TXVECTOR parameter CH_BANDWIDTH_IN_NON_HT is present and a control MPDU other than a CTS is being transmitted, then the TA field shall be set to a bandwidth signaling TA; otherwise, the TA field shall be set to an individual address.

NOTE—A CTS frame, even though it does not have a TA field, can also be transmitted with the TXVECTOR parameter CH_BANDWIDTH_IN_NON_HT present.

The TXVECTOR parameter CH_BANDWIDTH_IN_NON_HT shall not be present in PPDUs carrying management or data frames.

9.7.11 Rate selection constraints for VHT STAs

9.7.11.1 Rx Supported VHT-MCS and NSS Set

The Rx Supported VHT-MCS and NSS Set of a VHT STA is determined for each <VHT-MCS, NSS> tuple $NSS = 1, \dots, 8$ and bandwidth (20 MHz, 40 MHz, 80 MHz, and 160 MHz or 80+80 MHz) from its Supported VHT-MCS and NSS Set field as follows:

- If support for the VHT-MCS for NSS spatial streams at that bandwidth is mandatory (see 22.5), then the <VHT-MCS, NSS> tuple at that bandwidth is supported by the STA on receive.
- Otherwise, if the Max VHT-MCS For n SS subfield ($n = NSS$) in the Rx VHT-MCS Map subfield indicates support and the Rx Highest Supported Long GI Data Rate subfield is equal to 0, then the <VHT-MCS, NSS> tuple at that bandwidth is supported by the STA on receive.
- Otherwise, if the Max VHT-MCS For n SS subfield ($n = NSS$) in the Rx VHT-MCS Map subfield indicates support and the data rate for long GI of the MCS for NSS spatial streams at that bandwidth (expressed as the largest integer in Mb/s that is less than or equal to the data rate) is less than or equal to the rate represented by the Rx Highest Supported Long GI Data Rate subfield, then the <VHT-MCS, NSS> tuple at that bandwidth is supported by the STA on receive.
- Otherwise, the <VHT-MCS, NSS> tuple at that bandwidth is not supported by the STA on receive.

The <VHT-MCS, NSS> tuples excluded by 9.7.11.3 are also eliminated from the Rx Supported VHT-MCS and NSS Set.

A VHT STA shall not, unless explicitly stated otherwise, transmit a VHT PPDU unless the <VHT-MCS, NSS> tuple and bandwidth used are in the Rx Supported VHT-MCS and NSS Set of the receiving STA(s).

NOTE—Support for a <VHT-MCS, NSS> tuple at a given bandwidth implies support for both long GI and short GI on receive, if short GI is supported at that bandwidth.

9.7.11.2 Tx Supported VHT-MCS and NSS Set

The Tx Supported VHT-MCS and NSS Set of a VHT STA is determined for each <VHT-MCS, NSS> tuple $NSS = 1, \dots, 8$ and bandwidth (20 MHz, 40 MHz, 80 MHz, and 160 MHz or 80+80 MHz) from its Supported VHT-MCS and NSS Set field as follows:

- If support for the <VHT-MCS, NSS> tuple at that bandwidth is mandatory (see 22.5), then the <VHT-MCS, NSS> tuple at that bandwidth is supported by the STA on transmit.
- Otherwise, if the Max VHT-MCS for n SS subfield ($n = \text{NSS}$) in the Tx VHT-MCS Map subfield indicates support and the Tx Highest Supported Long GI Data Rate subfield is equal to 0, then the <VHT-MCS, NSS> tuple at that bandwidth is supported by the STA on transmit.
- Otherwise, if the Max VHT-MCS for n SS subfield ($n = \text{NSS}$) in the Tx VHT-MCS Map subfield indicates support and the data rate for long GI of the <VHT-MCS, NSS> tuple at that bandwidth (expressed as the largest integer in Mb/s that is less than or equal to the data rate) is less than or equal to the rate represented by the Tx Highest Supported Long GI Data Rate subfield, then the <VHT-MCS, NSS> tuple at that bandwidth is supported by the STA on transmit.
- Otherwise, the <VHT-MCS, NSS> tuple at that bandwidth is not supported by the STA on transmit.

NOTE—Support for short GI on transmit cannot be determined.

9.7.11.3 Additional rate selection constraints for VHT PPDUs

The following apply for a STA that transmits a VHT PDU with a number of spatial streams (NSS) less than or equal to 4:

- If the channel width of the PDU is equal to CBW20 or CBW40, then the STA should not use a <VHT-MCS, NSS> tuple if the VHT-MCS is equal to 0, 1, 2, or 3 and the HT MCS with value $\text{VHT-MCS} + 8 \times (\text{NSS} - 1)$ is marked as unsupported in the Rx MCS bitmask of the HT capabilities element of the receiver STA.
- If the channel width of the PDU is equal to CBW80, CBW160, or CBW80+80, then the STA should not use a <VHT-MCS, NSS> tuple if the VHT-MCS is equal to 0 or 1 and both the HT MCS values $2 \times \text{VHT-MCS} + 8 \times (\text{NSS} - 1)$ and $2 \times (\text{VHT-MCS} + 1) + 8 \times (\text{NSS} - 1)$ are marked as unsupported in the Rx MCS bitmask of the HT capabilities element of the receiver STA.

An example tabulation of this behavior is given in Table 9-5a.

Table 9-5a—Example of rate selection for VHT PPDUs

HT MCSs that are marked as unsupported	<VHT-MCS, NSS> tuples that are not used for CBW20 and CBW40	<VHT-MCS, NSS> tuples that are not used for CBW80, CBW160, and CBW80+80
0, 8, 16	<0, 1>, <0, 2>, <0, 3>	—
1, 9	<1, 1>, <1, 2>	—
10	<2, 2>	—
3	<3, 1>	—
0, 1	<0, 1>, <1, 1>	<0, 1>
2, 3	<2, 1>, <3, 1>	<1, 1>
0, 1, 8, 9	<0, 1>, <1, 1>, <0, 2>, <1, 2>	<0, 1>, <0, 2>

9.9 HT Control field operation

Change 9.9 as follows:

If the value of `dot11HTControlFieldSupported` is true, a STA shall set the `+HTC-HT` Support subfield of the HT Extended Capabilities field of the HT Capabilities element to 1 in HT Capabilities elements that it transmits. If the value of `dot11VHTControlFieldOptionImplemented` is true, a STA shall set the `+HTC-VHT` Support subfield of the VHT Capabilities Info field of the VHT Capabilities element to 1 in VHT Capabilities elements that it transmits.

A STA that has a value of true for at least one of `dot11RDResponderOptionImplemented`, `dot11MCSFeedbackOptionImplemented`, and `dot11AlternateEDCAImplemented` shall set `dot11HTControlFieldSupported` or `dot11VHTControlFieldOptionImplemented` or both to true.

An HT variant HT Control field shall not be present in a frame addressed to a STA unless that STA declares support for `+HTC-HT` in the HT Extended Capabilities field of its HT Capabilities element (see 8.4.2.58).

A VHT variant HT Control field shall not be present in a frame addressed to a STA unless that STA declares support for `+HTC-VHT` in the VHT Capabilities Info field of its VHT Capabilities element.

NOTE—An HT STA that does not support `+HTC (HT or VHT variant)` that receives a `+HTC` frame addressed to another STA still performs the CRC on the actual length of the MPDU and uses the Duration/ID field to update the NAV, as described in 9.3.2.4.

If the HT Control field is present in an MPDU aggregated in an A-MPDU, then all MPDUs of the same frame type (i.e., having the same value for the Type subfield of the Frame Control field) aggregated in the same A-MPDU shall contain an HT Control field. The HT Control field of all MPDUs containing the HT Control field aggregated in the same A-MPDU shall be set to the same value.

9.11 A-MSDU operation

Change the 11th paragraph of 9.11 as follows:

Support for the reception of an A-MSDU, where the A-MSDU is carried in a QoS data MPDU with Ack Policy equal to Normal Ack and the A-MSDU is not aggregated within an A-MPDU, is mandatory for an HT STA is mandatory in the following cases:

- For an HT STA if the A-MSDU is not aggregated within an A-MPDU
- For a VHT STA if the A-MSDU is sent as a VHT single MPDU.

Change the 13th paragraph of 9.11, and insert the subsequent paragraphs and note as follows:

A STA shall not transmit an A-MSDU in an HT PPDU to a STA that exceeds its maximum A-MSDU length capability if the A-MSDU length exceeds the value indicated by the Maximum A-MSDU Length field of the HT Capabilities element received from the recipient STA.

A VHT STA that sets the Maximum MPDU Length in the VHT Capabilities element to indicate 3895 octets shall set the Maximum A-MSDU Length in the HT Capabilities element to indicate 3839 octets. A VHT STA that sets the Maximum MPDU Length in the VHT Capabilities element to indicate 7991 octets or 11 454 octets shall set the Maximum A-MSDU Length in the HT Capabilities element to indicate 7935 octets.

The length of an A-MSDU transmitted in a VHT PPDU is limited by the maximum MPDU size supported by the recipient STA (see 9.12.5).

NOTE 1—An A-MSDU that meets the A-MSDU length limit for transmission in a VHT PPDU might exceed the A-MSDU length limit for an HT PPDU, in which case it cannot be retransmitted in an HT PPDU.

NOTE 2—Support for A-MSDU aggregation does not affect the maximum size of MSDU transported by the MA-UNITDATA primitives.

A VHT STA shall not transmit to a recipient VHT STA an A-MSDU that includes a number of MSDUs greater than the value indicated by the Max Number of MSDUs in A-MSDU field in the Extended Capabilities element received from the recipient STA.

9.12 A-MPDU operation

9.12.2 A-MPDU length limit rules

Change 9.12.2 as follows:

An HT STA and a DMG STA indicates a value in the Maximum A-MPDU Length Exponent field in its HT Capabilities element or DMG Capabilities element, respectively, that defines the maximum A-MPDU length that it can receive in an HT PPDU. A STA indicates in the Maximum A-MPDU Length Exponent field in its VHT Capabilities element the maximum length of the A-MPDU pre-EOF padding that it can receive in a VHT PPDU. A DMG STA indicates in the Maximum A-MPDU Length Exponent field in its DMG Capabilities element the maximum A-MPDU length that it can receive. The encoding of this field—these fields is defined in Table 8-125 for an HT STA HT PPDU, in Table 8-183v for a VHT PPDU, and in Table 8-183f for a DMG STA.

A VHT STA that sets the Maximum A-MPDU Length Exponent field in its VHT Capabilities element to a value in the range 0 to 3 shall set the Maximum A-MPDU Length Exponent in its HT Capabilities to the same value. A VHT STA that sets the Maximum A-MPDU Length Exponent field in the VHT Capabilities element to a value larger than 3 shall set the Maximum A-MPDU Length Exponent in its HT Capabilities element to 3.

Using this field—the Maximum A-MPDU Length Exponent fields in the HT Capabilities and VHT Capabilities elements, the STA establishes at association the maximum length of A-MPDU and A-MPDU pre-EOF padding that can be sent to it. The An HT STA shall be capable of receiving A-MPDUs of length up to the value indicated by this field—the Maximum A-MPDU Length Exponent field in its HT Capabilities element. A VHT STA shall be capable of receiving A-MPDUs where the A-MPDU pre-EOF padding length is up to the value indicated by the Maximum A-MPDU Length Exponent field in its VHT Capabilities element.

An HT STA and a DMG STA shall not transmit an A-MPDU in an HT PPDU that is longer than the value indicated by the Maximum A-MPDU Length Exponent field in the HT Capabilities element received from declared by the intended receiver. A STA shall not transmit an A-MPDU in a VHT PPDU where the A-MPDU pre-EOF padding length is longer than the value indicated by the Maximum A-MPDU Length Exponent field in the VHT Capabilities element received from the intended receiver. A DMG STA shall not transmit an A-MPDU that is longer than the value indicated by the Maximum A-MPDU Length Exponent field in the DMG Capabilities element received from the intended receiver.

A STA shall not transmit a VHT PPDU if the PPDU duration exceeds aPPDUMaxTime defined in Table 22-29.

NOTE—This restriction limits the maximum value in the LENGTH field in the L-SIG field of a VHT PPDU to 4095.

NOTE—The A-MPDU length limit applies to the maximum length of the PSDU that might be received. If the A-MPDU includes any padding delimiters (i.e., delimiters with the Length field equal to 0) in order to meet the MPDU start spacing requirement, this padding is included in this length limit.

9.12.3 Minimum MPDU Start Spacing field

Change the first paragraph of 9.12.3 as follows:

~~An HT STA and a DMG STA shall not start the transmission of more than one MPDU within the time limit described in the Minimum MPDU Start Spacing field declared by the intended receiver. To satisfy this requirement, the number of octets between the start of two consecutive MPDUs in an A-MPDU, measured at the PHY SAP, shall be equal to or greater than~~

$$t_{MMSS} \times r / 8$$

where

t_{MMSS} is the time (in microseconds) defined in the “Encoding” column of Table 8-125 for an HT STA and of Table 8-183f for a DMG STA for the value of the Minimum MPDU Start Spacing field

r is the value of the PHY Data Rate (in megabits per second) defined in Clause 21 for a DMG STA, ~~and defined in 20.6 for an HT STA HT PPDU, and in 22.5 for VHT PPDU based on the TXVECTOR parameters: MCS, GI_TYPE, and CH_BANDWIDTH.~~

9.12.4 A-MPDU aggregation of group addressed data frames

Change 9.12.4 as follows:

~~An HT STA that is neither an AP nor a mesh STA shall not transmit an A-MPDU containing an MPDU with a group addressed RA.~~

NOTE 1—An HT AP and an HT mesh STA can transmit an A-MPDU containing MPDUs with a group addressed RA.

NOTE 2—As a VHT STA is an HT STA, NOTE 1 also applies to VHT APs and VHT mesh STAs.

~~A STA that is an An HT-AP and an HT or a mesh STA shall not transmit an A-MPDU containing group addressed MPDUs if the HT Protection field is equal to non-HT mixed mode.~~

A DMG STA may transmit an A-MPDU containing MPDUs with a group addressed RA.

When a STA transmits a PPDU containing at least one A-MPDU that contains MPDUs with a group addressed RA, the following rules shall apply:

- If the PPDU is an HT PPDU, the value of maximum A-MPDU length exponent that applies is the minimum value in the Maximum A-MPDU Length Exponent subfields of the A-MPDU Parameters fields of the HT Capabilities elements across all HT STAs associated with the transmitting AP or across all peer HT mesh STAs of the transmitting mesh STA.
- If the PPDU is an HT PPDU, the value of minimum MPDU start spacing that applies is the maximum value in the Minimum MPDU Start Spacing subfields of the A-MPDU Parameters fields of the HT Capabilities elements across all HT STAs associated with the transmitting AP or across all peer HT mesh STAs of the transmitting mesh STA.
- If the PPDU is a VHT PPDU, the value of maximum A-MPDU length exponent that applies is the minimum value in the Maximum A-MPDU Length Exponent subfields of the A-MPDU Parameters fields of the VHT Capabilities elements across all VHT STAs associated with the transmitting AP or across all peer VHT mesh STAs.
- If the PPDU is a VHT PPDU, the value of minimum MPDU start spacing that applies is the maximum value in the Minimum MPDU Start Spacing subfields of the A-MPDU Parameters fields of the HT Capabilities elements across all VHT STAs associated with the transmitting AP or across all peer VHT mesh STAs of the transmitting mesh STA.

- If the PPDU is a DMG PPDU, the value of maximum A-MPDU length exponent that applies is the minimum value in the Maximum A-MPDU Length Exponent subfields of the A-MPDU Parameters fields of the DMG Capabilities elements across all DMG STAs associated with the PCP/AP.
- If the PPDU is a DMG PPDU, the value of minimum MPDU start spacing that applies is the maximum value in the Minimum MPDU Start Spacing subfields of the A-MPDU Parameters fields of the DMG Capabilities elements across all DMG STAs associated with the PCP/AP.

9.12.5 Transport of A-MPDU by the PHY data service

Change 9.12.5 as follows:

An A-MPDU shall be transmitted in a PSDU associated with a PHY-TXSTART.request primitive with the TXVECTOR parameter AGGREGATION parameter set to 1 or the TXVECTOR parameter FORMAT set to VHT. A received PSDU is determined to be an A-MPDU when the associated PHY-RXSTART.indication primitive RXVECTOR parameter AGGREGATION parameter is equal to 1 or the RXVECTOR parameter FORMAT is equal to VHT.

MPDUs in an A-MPDU carried in an HT PPDU shall be limited to a maximum length of 4095 octets.

A STA shall not transmit an MPDU in a VHT PPDU to a STA that exceeds the maximum MPDU length capability indicated in the VHT Capabilities element received from the recipient STA.

Insert the following subclauses, 9.12.6 to 9.12.8, after 9.12.5:

9.12.6 A-MPDU padding for VHT PPDU

A VHT STA that transmits a VHT PPDU, which contains one or more PSDUs, each of which contains an A-MPDU, shall construct the A-MPDU(s) as described in this subclause.

An A-MPDU pre-EOF padding (see 9.12.2) is constructed for each user from any of the following:

- A-MPDU subframes constructed from the MPDUs available for transmission that have a TID value that maps to the primary AC
- A-MPDU subframes with 0 in the MPDU Length field and 0 in the EOF field

provided that each added subframe and the A-MPDU pre-EOF padding meet all the following:

- A-MPDU content constraints (see 9.12.1) for the intended recipient
- Format and length limit constraints (see 8.6.1 and 9.12.2) for the intended recipient
- Minimum MPDU start spacing constraints (see 9.12.3) for the intended recipient
- TXOP duration limits (see 9.19.2.2) for the primary AC

The A-MPDU_Length[n] for user n is initialized as the length of the resulting A-MPDU pre-EOF padding.

This initial value of A-MPDU_Length[n] for user n is used as the APEP_LENGTH[n] parameter value for the PLME-TXTIME.request primitive (see 6.5.7). The PLME-TXTIME.request primitive is then invoked once for the VHT PPDU. The PLME-TXTIME.confirm primitive (see 6.5.8) provides the TXTIME parameter and PSDU_LENGTH[] parameters for all the users for the transmission.

Subsequently, for each user n , as permitted by the rules for EDCA TXOP Sharing (see 9.19.2.3a), a VHT STA may add A-MPDU subframes to the A-MPDU for that user that meets either of the following conditions:

- Have a TID that maps to an AC that is not the primary AC

- Have 0 in the MPDU Length field and 0 in the EOF field

provided that each added subframe and the resulting A-MPDU meet all of the following:

- A-MPDU content constraints (see 9.12.1) for the intended recipient
- Length limit constraints (see 8.6.1 and 9.12.2) for the intended recipient
- MPDU start spacing constraints (see 9.12.3) for the intended recipient

and provided that, after incrementing the A-MPDU_Length[n] with the length of each such added A-MPDU subframe, the relationship A-MPDU_Length[n] \leq PSDU_LENGTH[n] is true.

NOTE—An A-MPDU is prohibited by the rules in 9.12.1 from carrying MPDUs of more than one TID.

Subsequently, for each user n , a VHT STA may add A-MPDU subframes to the A-MPDU for that user that meet the following condition:

- Have 0 in the MPDU Length field

provided that each added subframe and the resulting A-MPDU meet the following condition:

- Length limit constraints (see 8.6.1 and 9.12.2) for the intended recipient

and provided that, after incrementing the A-MPDU_Length[n] with the length of each such added A-MPDU subframe, the relationship A-MPDU_Length[n] \leq PSDU_LENGTH[n] is true.

An implementation may reduce the A-MPDU_Length[n] by the amount of padding for user n which was added subsequent to the addition of a subframe for user n that contains 1 in the EOF field.

The final value of A-MPDU_Length[] shall be used as APEP_LENGTH[] in the PHY-TXSTART.request primitive for the VHT PPDU.

Padding is then added for each user such that the resulting A-MPDU contains exactly PSDU_LENGTH octets for that user as follows:

- First, while A-MPDU_Length[n] $<$ PSDU_LENGTH[n] and A-MPDU_Length[n] mod 4 \neq 0, add a subframe pad octet and increment A-MPDU_Length[n] by 1.
- Then, while A-MPDU_Length[n] + 4 \leq PSDU_LENGTH[n], add an A-MPDU subframe with 0 in the MPDU Length field and 1 in the EOF field and increment A-MPDU_Length[n] by 4.
- Finally, while A-MPDU_Length[n] $<$ PSDU_LENGTH[n], add an EOF pad octet and increment A-MPDU_Length[n] by 1.

An A-MPDU subframe with EOF set to 1 and with MPDU Length field set to 0 shall not be added before any A-MPDU subframe with EOF set to 0.

An A-MPDU subframe with EOF set to 1 and with MPDU Length field set to 0 shall not be added before an A-MPDU subframe that contains a VHT single MPDU (see 9.12.7).

An EOF pad octet shall not be added before any A-MPDU subframe.

The values of the subframe pad octets and EOF pad octets are unspecified.

9.12.7 Setting the EOF field of the MPDU delimiter

The EOF field of an A-MPDU subframe with an MPDU Length field with a nonzero value that is the only A-MPDU subframe with an MPDU Length field with a nonzero value in an A-MPDU carried in a VHT PPDU may be set to 1. The EOF field of each A-MPDU subframe with an MPDU Length field with a

nonzero value that is not the only A-MPDU subframe with MPDU Length field with a nonzero value in the A-MPDU carried in a VHT PPDU shall be set to 0. The EOF field shall be set to 0 in all A-MPDU subframes that are carried in an HT PPDU.

An MPDU that is the only MPDU in an A-MPDU and that is carried in an A-MPDU subframe with 1 in the EOF field is called a VHT single MPDU.

9.12.8 Transport of VHT single MPDUs

The rules for VHT single MPDU operation are the same as the rules for non-A-MPDU frame operation with other types of non-A-MPDU.

NOTE—This affects the following behavior:

- The MPDU could carry a fragment of an MSDU or MMPDU (see 9.2.7).
- Rate selection of control responses (see 9.7).
- A data MPDU cannot indicate an Ack Policy of “Implicit Block Ack”, and does not generate a Block Ack response (see 8.2.4.5.4).
- A data MPDU could indicate an Ack Policy of “Normal Ack”, which solicits an ACK immediate response. No Block Ack agreement is needed in this case (see 8.2.4.5.4).
- The MPDU could be a management frame that solicits an ACK response (see 8.6.3).

9.15 STBC operation

Change 9.15 as follows:

Only a STA that has not sets the Tx STBC subfield to 1 in the HT Capabilities element may shall not transmit frames HT PPDUs with a TXVECTOR parameter STBC set to a nonzero value to a STA from which the most recently received value of the Rx STBC field of the HT Capabilities element is nonzero. A STA that has not set the Tx STBC subfield to 1 in the VHT Capabilities element shall not transmit VHT SU PPDUs with a TXVECTOR parameter STBC set to a nonzero value.

A STA shall not send a HT PPDU with the TXVECTOR parameter STBC set to a nonzero value to a recipient STA unless the recipient STA has indicated in the Rx STBC field of its HT Capabilities element that it supports the reception of PPDUs using STBC with a number of spatial streams equal to or greater than the number of spatial streams in the HT PPDU. A STA shall not send a VHT PPDU with the TXVECTOR parameter STBC set to a nonzero value to a recipient STA unless the recipient STA has indicated in the Rx STBC field of its VHT Capabilities element that it supports the reception of PPDUs using STBC with a number of spatial streams equal to or greater than the number of spatial streams in the VHT PPDU.

9.16 Short GI operation

Change 9.16 as follows:

A STA may transmit a frame with TXVECTOR parameters CH_BANDWIDTH set to HT_CBW20 and GI_TYPE set to SHORT_GI only if all of the following conditions are met:

- The STA is an HT STA.
- The TXVECTOR parameter FORMAT is equal to HT_MF, ~~or~~ HT_GF, or VHT.
- The RA of the frame corresponds to a STA for which the Short GI for 20 MHz subfield of the ~~most recently received~~ HT Capabilities element contained a value of 1.
- dot11ShortGIOptionInTwentyActivated is present and is true.

A STA may transmit a frame with TXVECTOR parameters CH_BANDWIDTH set to HT_CBW40 and GI_TYPE set to SHORT_GI only if all of the following conditions are met:

- The STA is an HT STA.
- The TXVECTOR parameter FORMAT is equal to HT_MF, ~~or~~ HT_GF, or VHT.
- The RA of the frame corresponds to a STA for which the Short GI for 40 MHz subfield of the ~~most recently received~~ HT Capabilities element contained a value of 1.
- dot11ShortGIOptionInFortyActivated is present and is true.

A STA shall not transmit a frame with TXVECTOR parameters CH BANDWIDTH set to CBW80 and GI TYPE set to SHORT GI unless all of the following conditions are met:

- The STA is a VHT STA.
- The TXVECTOR parameter FORMAT is equal to VHT.
- The RA of the frame corresponds to a STA for which the Short GI for 80 MHz subfield of the VHT Capabilities element contained a value of 1.
- dot11VHTShortGIOptionIn80Activated is present and is true.

A STA may transmit a frame with TXVECTOR parameters CH BANDWIDTH set to CBW160 or CBW80+80 and GI TYPE set to SHORT GI only if all of the following conditions are met:

- The STA is a VHT STA.
- The TXVECTOR parameter FORMAT is equal to VHT.
- The RA of the frame corresponds to a STA for which the Short GI for 160 and 80+80 MHz subfield of the VHT Capabilities element contained a value of 1.
- dot11VHTShortGIOptionIn160and80p80Activated is present and is true.

A STA may transmit a frame with TXVECTOR parameters FORMAT set to VHT, NUM USERS set to greater than 1, and GI TYPE set to SHORT GI only if all of the following conditions are met:

- The STA is a VHT STA.
- The TXVECTOR parameter FORMAT is equal to VHT.
- The RAs of all MPDUs in the VHT MU PPDU correspond to STAs for which the Short GI subfield of the following conditions are satisfied:
 - If the TXVECTOR parameter CH BANDWIDTH is set to CBW20, the Short GI for 20 MHz subfields of the HT Capabilities element contained a value of 1, and dot11ShortGIOptionInTwentyActivated is present and is true.
 - If the TXVECTOR parameter CH BANDWIDTH is set to CBW40, the Short GI for 40 MHz subfields of the HT Capabilities element contained a value of 1, and dot11ShortGIOptionInFortyActivated is present and is true.
 - If the TXVECTOR parameter CH BANDWIDTH is set to CBW80, the Short GI for 80 MHz subfields of the VHT Capabilities element contained a value of 1, and dot11ShortGIOptionIn80Activated is present and is true.
 - If the TXVECTOR parameter CH BANDWIDTH is set to CBW160 or CBW80+80, the Short GI for 160 MHz and 80+80 MHz subfields of the VHT Capabilities element contained a value of 1, and dot11VHTShortGIOptionIn160and80p80Activated is present and is true.

An HT STA shall not transmit a frame with the TXVECTOR parameter FORMAT set to HT_GF and the GI_TYPE parameter set to SHORT_GI when the MCS parameter indicates a single spatial stream.

Further restrictions on TXVECTOR parameter values may apply due to rules found in 9.22 and 9.7.

Insert the following subclause, 9.17a (including Table 9-5b), after 9.17:

9.17a Group ID and partial AID in VHT PPDUs

The partial AID is a non-unique STA identifier defined in Table 9-5b. The partial AID is carried in the TXVECTOR parameter PARTIAL_AID of a VHT SU PDU and is limited to 9 bits.

A STA transmitting a VHT SU PDU carrying one or more group addressed MPDUs or transmitting a VHT NDP intended for multiple recipients shall set the TXVECTOR parameters GROUP_ID to 63 and PARTIAL_AID to 0. The intended recipient of a VHT NDP is defined in 9.31.6.

A STA transmitting a VHT SU PDU carrying one or more individually addressed MPDUs or a VHT NDP intended for a single recipient shall set the TXVECTOR parameters GROUP_ID and PARTIAL_AID as shown in Table 9-5b.

Table 9-5b—Settings for the TXVECTOR parameters GROUP_ID and PARTIAL_AID

Condition	GROUP_ID	PARTIAL_AID
Addressed to AP	0	BSSID[39:47]
Addressed to Mesh STA	0	RA[39:47]
Sent by an AP and addressed to a STA associated with that AP or sent by a DLS or TDLS STA in a direct path to a DLS or TDLS peer STA	63	$(dec(AID[0:8]) + dec(BSSID[44:47] \oplus BSSID[40:43]) \times 2^5) \bmod 2^9$ (9-8a) where \oplus is a bitwise exclusive OR operation $\bmod X$ indicates the X-modulo operation $dec(A[b:c])$ is the cast to decimal operator where b is scaled by 2^0 and c by 2^{c-b}
Otherwise (see NOTE)	63	0
NOTE—The last row covers the following cases: — A PDU sent to an IBSS STA — A PDU sent by an AP to a non associated STA — Any other condition not explicitly listed elsewhere in the table		

In Table 9-5b:

- AID[$b:c$] represents bits b to c inclusive of the AID of the recipient STA with bit 0 being the first transmitted.
- BSSID[$b:c$] represents bits b to c inclusive of the BSSID, with bit 0 being the Individual/Group bit. In this representation, the Individual/Group bit is BSSID[0] and BSSID[47] is the last transmitted bit.
- RA[$b:c$] represents bits b to c inclusive of the RA field, with bit 0 being the Individual/Group bit. In this representation, the Individual/Group bit is RA[0] and RA[47] is the last transmitted bit.

A STA shall include the values computed in Table 9-5b in the PHYCONFIG_VECTOR parameters PARTIAL_AID_LIST_GID00 and PARTIAL_AID_LIST_GID63.

A STA that transmits a VHT PPDU to a DLS or TDLS peer STA obtains the AID for the peer STA from the DLS Setup Request, DLS Setup Response, TDLS Setup Request or TDLS Setup Response frame.

An AP should not assign an AID to a STA that results in a 0 value PARTIAL_AID (as computed using Equation (9-8a)).

A STA transmitting a VHT MU PPDU sets the TXVECTOR parameter GROUP_ID as described in 22.3.11.4.

As an example of the GROUP_ID and PARTIAL_AID setting, consider the case of a BSS with BSSID 00-21-6A-AC-53-52² that has as a member a non-AP STA assigned AID 5. In VHT PDUs sent to an AP, the GROUP_ID is set to 0 and the PARTIAL_AID is set to 164. In VHT PDUs sent by the AP to the non-AP STA associated with that AP, the GROUP_ID is set to 63 and PARTIAL_AID is set to 229.

9.18 Operation across regulatory domains

Change 9.18.5 (including the subclause title) as follows:

9.18.5 Operation with operating classes and the VHT Transmit Power Envelope element

When dot11OperatingClassesImplemented is true, the following statements apply:

- When dot11OperatingClassesRequired is false, or where operating classes domain information is not present in a STA, that STA is not required to change its operation in response to an element or element-specific Information field that contains an operating class.
- When dot11OperatingClassesRequired is true, or where operating classes domain information is present in a STA, the STA shall indicate current operating class information in the Country element and Supported Operating Classes element, except that a VHT STA may omit, from the Country element, any Operating Triplet field for an Operating Class for which the Channel spacing (MHz) column indicates 80 MHz or wider and for which the Behavior limits set column in the applicable table in Annex E contains only a blank entry or either or both of “80+” and “UseEirpForVHTTxPowEnv.”
- When dot11OperatingClassesRequired and dot11ExtendedChannelSwitchActivated are true and a STA is capable of operating as specified in more than one operating class, the STA shall include the Supported Operating Classes element in Association frames and Reassociation frames.
- When dot11OperatingClassesRequired is true, or where operating classes domain information is present and the STA parsing a Country element finds an invalid First Channel Number field or Operating Class field with a value that is reserved, the STA shall ignore the remainder of the Country element and shall parse any remaining management frame body for additional elements.

A VHT STA that has dot11SpectrumManagementRequired or dot11RadioMeasurementActivated equal to true shall determine a local maximum transmit power from a VHT Transmit Power Envelope element for which the Local Maximum Transmit Power Unit Interpretation subfield indicates EIRP.

A STA that sends two or more VHT Transmit Power Envelope elements in a frame shall order the elements by increasing values of their Local Maximum Transmit Power Unit Interpretation subfields.

When a VHT STA finds an unknown value in the Local Maximum Transmit Power Unit Interpretation subfield in a VHT Transmit Power Envelope element, then the STA shall ignore that and subsequent VHT Transmit Power Envelope elements.

²As described in IEEE Std 802-2001, the use of hyphens for the BSSID indicates hexadecimal representation rather than bit-reversed representation.

A STA that receives two or more VHT Transmit Power Envelope elements in the same frame with known values in their Local Maximum Transmit Power Unit Interpretation subfields shall process all the elements according to the local regulations known at the STA.

NOTE—If a STA receives two VHT Transmit Power Envelope elements, each with a known value in the Local Maximum Transmit Power Unit Interpretation subfield, then the expected possibilities are as follows:

- The STA complies with either element (shared spectrum).
- The STA complies with both elements (tightened regulations), or
- The STA complies with the second element (changed regulations).

9.19 HCF

9.19.2 HCF contention-based channel access (EDCA)

9.19.2.2 EDCA TXOPs

Change the first paragraph of 9.19.2.2 as follows:

There are ~~two~~ three modes of EDCA TXOP defined, the initiation of the EDCA TXOP, the sharing of the EDCA TXOP, and the multiple frame transmission within an EDCA TXOP. An initiation of the TXOP occurs when the EDCA rules permit access to the medium. The sharing of the EDCA TXOP occurs when an EDCAF has obtained access to the medium, making the corresponding AC the primary AC, and includes traffic from queues associated with other ACs in VHT MU PPDU transmitted during the TXOP. A multiple frame transmission within the TXOP occurs when an EDCAF retains the right to access the medium following the completion of a frame exchange sequence, such as on receipt of an ACK ~~frame~~.

Change the third paragraph of 9.19.2.2 as follows:

A TXOP limit value of 0 indicates that the TXOP holder may transmit or cause to be transmitted (as responses) the following within the current TXOP:

- a) A single MSDU, MMPDU, A-MSDU, or A-MPDU One of the following at any rate, subject to the rules in 9.7:
 - 1) SU PPDU carrying fragments of a single MSDU or MMPDU
 - 2) An SU PPDU or a VHT MU PPDU carrying a single MSDU, a single MMPDU, a single A-MSDU, or a single A-MPDU
 - 3) A VHT MU PPDU carrying A-MPDUs to different users
- b) Any required acknowledgments
- c) Any frames required for protection, including one of the following:
 - 1) An RTS/CTS exchange
 - 2) CTS to itself
 - 3) Dual CTS as specified in 9.3.2.8 (Dual CTS protection)
- d) Any frames required for beamforming as specified in 9.27 and in 9.31.5
- e) Any frames required for link adaptation as specified in 9.28
- f) Any number of BlockAckReq and BlockAck frames

NOTE 1—This is a rule for the TXOP holder. A TXOP responder need not be aware of the TXOP limit nor of when the TXOP was started.

NOTE 2—This rule prevents the use of RD when the TXOP limit is 0.

Change the sixth paragraph of 9.19.2.2 as follows:

When the TXOP limit is nonzero, a STA shall fragment an individually addressed MSDU so that the transmission of the first MPDU of the TXOP does not cause the TXOP limit to be exceeded at the PHY rate selected for the initial transmission attempt of that MPDU. The TXOP limit may be exceeded, when using a lower PHY rate than selected for the initial transmission attempt of the first MPDU, for a retransmission of an MPDU, for the initial transmission of an MPDU if any previous MPDU in the current MSDU has been retransmitted, or for group addressed MSDUs. The TXOP limit may also be exceeded by transmitting a VHT NDP Announcement frame and NDP or by transmitting a Beamforming Report Poll frame that fit within the TXOP limit but the response and the immediately preceding SIFS cause the TXOP limit to be exceeded. When the TXOP limit is exceeded due to the retransmission of an MPDU at a reduced PHY rate, the STA shall not transmit more than one MPDU in the TXOP.

Change the last paragraph of 9.19.2.2 as follows:

A STA shall save the TXOP holder address for the BSS in which it is associated, which is the MAC address from the Address 2 field of the frame that initiated a frame exchange sequence except when this is a CTS frame, in which case the TXOP holder address is the Address 1 field. If the TXOP holder address is obtained from a control frame, a VHT STA shall save the non-bandwidth signaling TA value obtained from the Address 2 field. If a non-VHT STA receives an RTS frame is received with the RA address matching the MAC address of the STA and the MAC address in the TA field in the RTS frame matches the saved TXOP holder address, then the STA shall send the CTS frame after SIFS, without regard for, and without resetting, its NAV. If a VHT STA receives an RTS frame with the RA address matching the MAC address of the STA and the non-bandwidth signaling TA value obtained from the Address 2 field in the RTS frame matches the saved TXOP holder address, then the STA shall send the CTS frame after SIFS, without regard for, and without resetting, its NAV. When a STA receives a frame addressed to it that requires an immediate response, except ~~in the case of an~~ for RTS, it shall transmit the response independent of its NAV. The saved TXOP holder address shall be cleared when the NAV is reset or when the NAV counts down to 0.

9.19.2.3 Obtaining an EDCA TXOP***Insert the following paragraph at the beginning of 9.19.2.3:***

When a STA and the BSS, of which the STA is a member, both support multiple channel widths, an EDCA TXOP is obtained based solely on activity of the primary channel. “Idle medium” in this subclause means “idle primary channel.” Likewise “busy medium” means “busy primary channel.” Once an EDCA TXOP has been obtained according to this subclause, further constraints defined in 10.15.9 and 9.19.2.8 might limit the width of transmission during the TXOP or deny the channel access, based on the state of CCA on secondary channel, secondary 40 MHz channel, or secondary 80 MHz channel.

Change the now fifth paragraph of 9.19.2.3 (including inserting a note) as follows:

On specific slot boundaries as determined on the primary channel, each EDCAF shall make a determination to perform one and only one of the following functions:

- Initiate the transmission of a frame exchange sequence for that access function.
- Decrement the backoff timer for that access function.
- Invoke the backoff procedure due to an internal collision.
- Do nothing for that access function.

NOTE—In the case that an EDCAF gains access to the channel and transmits MSDUs, A-MSDUs, or MMPDUs from a secondary AC, the EDCAF of the secondary AC is not affected by this operation. If the EDCAF of a secondary AC experiences an internal collision with the EDCAF that gained access to the channel, it performs the backoff procedure regardless of the transmission of any of its MSDUs, A-MSDUs, or MMPDUs.

Insert the following subclause, 9.19.2.3a (including Figure 9-20a), after 9.19.2.3:

9.19.2.3a Sharing an EDCA TXOP

This mode applies only to an AP that supports DL-MU-MIMO. The AC associated with the EDCAF that gains an EDCA TXOP becomes the primary AC. TXOP sharing is allowed when primary AC traffic is transmitted in a VHT MU PPDU and resources permit traffic from secondary ACs to be included, targeting up to four STAs. The inclusion of secondary AC traffic in a VHT MU PPDU shall not increase the duration of the VHT MU PPDU beyond that required to transport the primary AC traffic. If a destination is targeted by frames in the queues of both the primary AC and at least one secondary AC, the frames in the primary AC queue shall be transmitted to the destination first, among a series of downlink transmissions within a TXOP. The decision of which secondary ACs and destinations are selected for TXOP sharing, as well as the order of transmissions, are implementation specific and out of scope for this specification.

When sharing, the TXOP duration that applies is the TXOP limit of the primary AC.

NOTE—An AP can protect the immediate response by preceding the VHT MU PPDU (which might have TXVECTOR parameter NUM_USERS > 1) with an RTS/CTS exchange or a CTS-to-self transmission.

An illustration of TXOP sharing is shown in Figure 9-20a. In this figure, the AP has frames in queues of three of its ACs. It is assumed that the TXOP was obtained by AC_VI and is shared by AC_VO and AC_BE. It is also assumed that these frames are targeting three STAs, STA-1 to STA-3.

9.19.2.4 Multiple frame transmission in an EDCA TXOP

Change 9.19.2.4 as follows:

Multiple frames may be transmitted in an EDCA TXOP that was acquired following the rules in 9.19.2.3 if there is more than one frame pending in the primary AC for which the channel has been acquired. However, those frames that are pending in other ACs shall not be transmitted in this EDCA TXOP except when sent in a VHT MU PPDU with TXVECTOR parameter NUM_USERS > 1 and if allowed by the rules in 9.19.2.3a. If a TXOP holder has in its transmit queue an additional frame of the same primary AC as the one just transmitted and the duration of transmission of that frame plus any expected acknowledgment for that frame is less than the remaining TXNAV timer value, then the STA-TXOP holder may commence transmission of that frame a SIFS (or RIFS, under if the conditions defined in 9.3.2.3.2 are met) after the completion of the immediately preceding frame exchange sequence, subject to the TXOP limit restriction as described in 9.19.2.2. A STA shall not commence the transmission of an RTS with a bandwidth signaling TA until at least PIFS time after the immediately preceding frame exchange sequence. An HT STA that is a TXOP holder may transmit multiple MPDUs of the same AC within an A-MPDU as long as the duration of transmission of the A-MPDU plus any expected BlockAck response is less than the remaining TXNAV timer value.

NOTE 1—PIFS is used by a VHT STA to perform CCA in the secondary 20 MHz, 40 MHz, and 80 MHz channels before receiving RTS.

NOTE 2—An RD responder can transmit multiple MPDUs as described in 9.24.4.

The TXNAV timer is a timer that is initialized with the duration from the Duration/ID field in the frame most recently successfully transmitted by the TXOP holder. The TXNAV timer begins counting down from the end of the transmission of the PPDU containing that frame. Following the BlockAck response, the HT STA may start transmission of another MPDU or A-MPDU a SIFS after the completion of the immediately preceding frame exchange sequence. The HT STA may retransmit unacknowledged MPDUs within the same TXOP or in a subsequent TXOP.

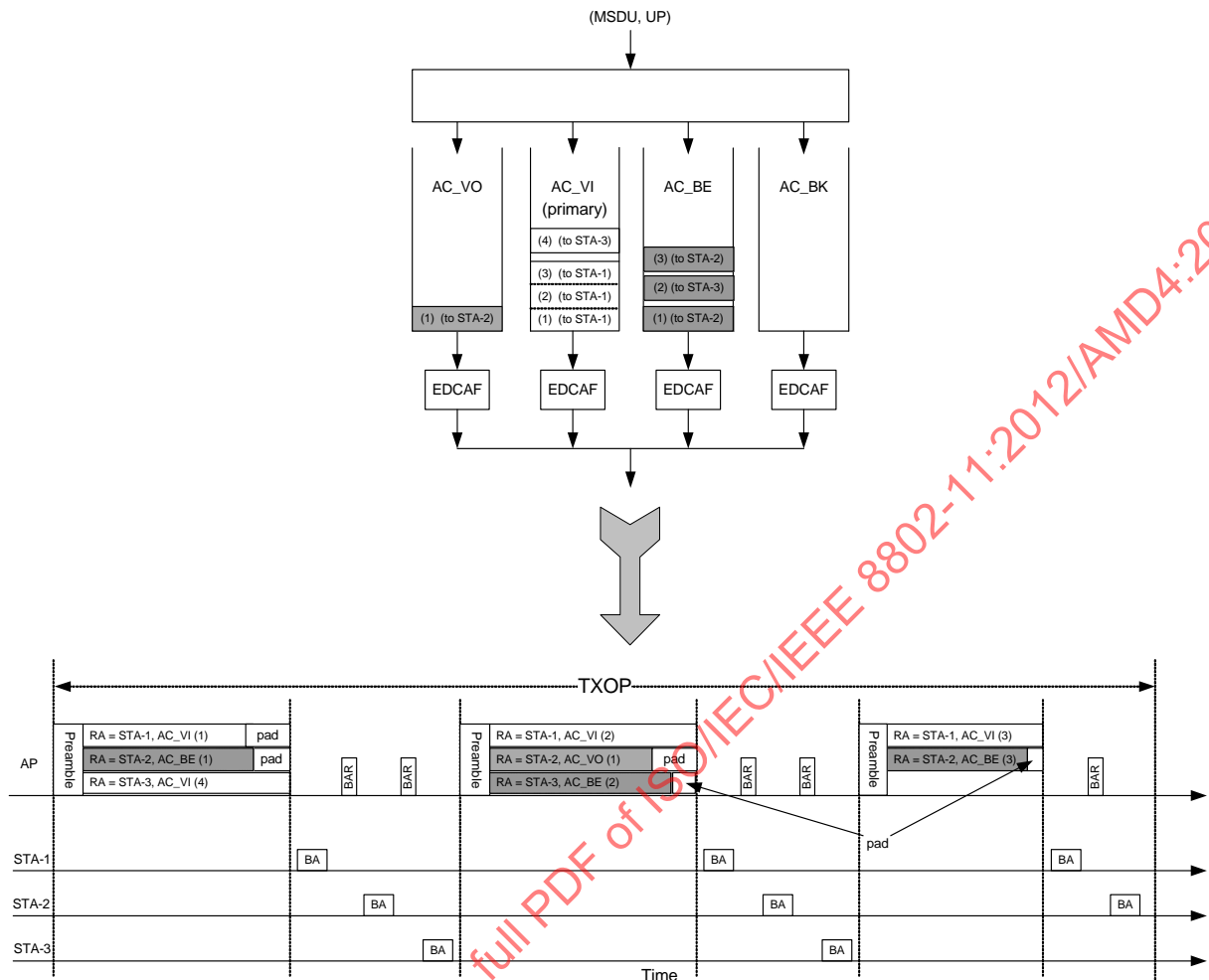

Figure 9-20a—Illustration of TXOP sharing and PDU construction

After a valid response to the initial frame of a TXOP, if the Duration/ID field is set for multiple frame transmission and there is a subsequent transmission failure, the corresponding channel access function may transmit after the CS mechanism (see 9.3.2.1) indicates that the medium is idle at the TxPIFS slot boundary (defined in 9.3.7) before the expiry of the TXNAV timer. At the expiry of the TXNAV timer, if the channel access function has not regained access to the medium, then the EDCAF shall invoke the backoff procedure that is described in 9.19.2.5. Transmission failure is defined in 9.19.2.5.

All other channel access functions at the STA shall treat the medium as busy until the expiry of the TXNAV timer.

A frame exchange may be a group addressed frame, a frame transmitted with No Ack policy (for which there is no expected acknowledgment), or an individually addressed frame followed by a correctly received ACK frame transmitted by a STA (either a non-AP STA or an AP).

A frame exchange may be one of the following:

- A frame not requiring immediate acknowledgment (such as a group addressed frame or a frame transmitted with No Ack policy or Block Ack policy) or an A-MPDU containing only such frames

- A frame requiring acknowledgment (such as an individually addressed frame transmitted with Normal Ack policy) or an A-MPDU containing at least one such frame, followed after SIFS by a corresponding acknowledgment frame
- Either
 - a VHT NDP Announcement frame followed after SIFS by a VHT NDP, or
 - a Beamforming Report Poll frame

followed after SIFS by a PPDU containing one or more VHT Compressed Beamforming frames

Note that, as for an EDCA TXOP, a multiple frame transmission is granted to an EDCAF, not to a STA, so that the multiple frame transmission is permitted only for the transmission of a frame of the same AC as the frame that was granted the EDCA TXOP, unless the EDCA TXOP obtained is used by an AP for a PSMP sequence or a VHT MU PPDU with TXVECTOR parameter NUM_USERS > 1.

In ~~such a~~ the case of PSMP, this AC transmission restriction does not apply to either the AP or the STAs participating in the PSMP sequence, but the specific restrictions on transmission during a PSMP sequence described in 9.26 do apply.

When permitted by the rules in 9.19.2.3a, traffic from secondary ACs may be transmitted in a VHT MU PPDU that has TXVECTOR parameter NUM_USERS > 1 and that carries traffic for the primary AC.

If a TXOP is protected by an RTS or CTS frame carried in a non-HT or a non-HT duplicate PPDU, the TXOP holder shall set the TXVECTOR parameter CH_BANDWIDTH of a PPDU as follows:

- To be the same or narrower than RXVECTOR parameter CH_BANDWIDTH_IN_NON_HT of the last received CTS frame in the same TXOP, if the RTS frame with a bandwidth signaling TA and TXVECTOR parameter DYN_BANDWIDTH_IN_NON_HT set to Dynamic has been sent by the TXOP holder in the last RTS/CTS exchange.
- Otherwise, to be the same or narrower than the TXVECTOR parameter CH_BANDWIDTH of the RTS frame that has been sent by the TXOP holder in the last RTS/CTS in the same TXOP.

If there is no RTS/CTS exchange in non-HT duplicate format in a TXOP and there is at least one non-HT duplicate frame exchange in a TXOP, the TXOP holder shall set the CH_BANDWIDTH parameter in TXVECTOR of a PPDU sent after the first non-HT duplicate frame to be the same or narrower than the CH_BANDWIDTH parameter in TXVECTOR of the initial frame in the first non-HT duplicate frame exchange in the same TXOP.

If there is no non-HT duplicate frame exchange in a TXOP, the TXOP holder shall set the TXVECTOR parameter CH_BANDWIDTH of a non-initial PPDU to be the same or narrower than the TXVECTOR parameter CH_BANDWIDTH of the preceding PPDU that it has transmitted in the same TXOP.

If a TXOP is protected by a CTS-to-self frame carried in a non-HT or non-HT duplicate PPDU, the TXOP holder shall set the TXVECTOR parameter CH_BANDWIDTH of a PPDU to be the same or narrower than the TXVECTOR parameter CH_BANDWIDTH of the CTS-to-self in the same TXOP.

NOTE—The bandwidth of a PS-Poll frame does not constrain the bandwidth of an immediate data response to that PS-Poll frame.

9.19.2.5 EDCA backoff procedure

Change 9.19.2.5 as follows:

Each EDCAF shall maintain a state variable CW[AC], which shall be initialized to the value of the parameter CWmin[AC].

For the purposes of this subclause, successful transmission and transmission failure of an MPDU are defined as follows:

- After transmitting an MPDU (~~regardless of whether even if it is carried in an A-MPDU or as part of a VHT MU PPDU that might have TXVECTOR parameter NUM_USERS > 1~~) that requires an immediate frame as a response, the STA shall wait for a timeout interval of duration of aSIFSTime + aSlotTime + aPHY-RX-START-Delay, starting at the PHY-TXEND.confirm primitive. If a PHYRXSTART.indication does not occur during the timeout interval, the STA concludes that the transmission of the MPDU has failed.
- If a PHY-RXSTART.indication primitive does occur during the timeout interval, the STA shall wait for the corresponding PHY-RXEND.indication primitive to determine whether the MPDU transmission was successful. The recognition of a valid response frame sent by the recipient of the MPDU requiring a response, corresponding to this PHY-RXEND.indication primitive, shall be interpreted as a successful response.
- The recognition of a valid data frame sent by the recipient of a PS-Poll frame shall also be accepted as successful acknowledgment of the PS-Poll frame.
- ~~A~~The transmission of an MPDU that does not require an immediate frame as a response is defined as a successful transmission, unless it is one of the nonfinal (re)transmissions of an MPDU that is delivered using the GCR unsolicited retry retransmission policy (9.19.2.6.2).
- The nonfinal (re)transmission of an MPDU that is delivered using the GCR unsolicited retry retransmission policy (9.19.2.6.2)) is defined to be a failure.
- The final (re)transmission of an MPDU that is delivered using the GCR unsolicited retry retransmission policy (9.19.2.6.2) is defined as a successful transmission.
- The recognition of anything else, including any other valid frame, shall be interpreted as failure of the MPDU transmission.

The backoff procedure shall be invoked for an EDCAF when any of the following events occurs:

- a) A frame with that AC is requested to be transmitted, the medium is busy on the primary channel as indicated by either physical or virtual CS, and the backoff timer has a value of 0 for that AC.
- b) The ~~final~~ transmission of the MPDU in the final PPDU transmitted by the TXOP holder initiated during the TXOP for that AC was successful as defined in this subclause and the TXNAV timer has expired, and the AC was a primary AC.
- c) The ~~transmission of expected immediate response to the initial frame of a TXOP of that AC fails~~ is not received, and the AC was a primary AC.
- d) ~~An internal collision is reported for that EDCAF (see 9.19.2.3). The transmission attempt collides internally with another EDCAF of an AC that has higher priority, that is, two or more EDCAFs in the same STA are granted a TXOP at the same time.~~
- e) The transmission attempt of a STA coordinated by an MM-SME collides internally with another STA coordinated by the same MM-SME (see 10.33), which is indicated to the first MAC entity with a PHY-TxBusy.indication (BUSY) as response to the PHY-TXSTART.request primitive.

NOTE—For the purpose of this subclause, reception of a valid immediate response to any of the MPDUs in this PPDU determines that transmission of all MPDUs in the PPDU was successful.

In addition, the backoff procedure may be invoked for an EDCAF when the transmission of the MPDUs in a non-initial frame-PPDU by the TXOP holder fails.

NOTE—A STA can perform a PIFS recovery as described in 9.19.2.4 or perform a backoff as described in the previous paragraph as a response to transmission failure within a TXOP. How it chooses between these two is implementation dependent.

A STA that performs a backoff within its existing TXOP shall not extend the TXNAV timer value.

NOTE—In other words, the backoff is a continuation of the TXOP, not the start of a new TXOP.

If the backoff procedure is invoked for reason a) above, the value of CW[AC] shall be left unchanged. If the backoff procedure is invoked because of reason b) above, the value of CW[AC] shall be reset to CW_{min}[AC].

NOTE—If condition b) or c) occurs for a secondary AC, the backoff for the associated EDCAF continues without change to the backoff counter or to the value of CW[AC].

QoS STAs shall maintain a short retry counter and a long retry counter for each MSDU, A-MSDU, or MMPDU that belongs to a TC that requires acknowledgment. The initial value for the short and long retry counters shall be 0. QoS STAs also maintain a short retry counter and a long retry counter for each AC. They are defined as QSRC[AC] and QLRC[AC], respectively, and each is initialized to a value of 0. When dot11RobustAVStreamingImplemented is true, QoS STAs shall maintain a short drop-eligible retry counter and a long drop-eligible retry counter for each AC. They are defined as QSDRC[AC] and QLDRC[AC], respectively, and each is initialized to a value of zero. APs with dot11RobustAVStreamingImplemented true and mesh STAs with dot11MeshGCRImplemented true, shall maintain an unsolicited retry counter.

If the backoff procedure is invoked because of a failure event [reason c) or d) or e) above or the transmission failure of a non-initial frame by the TXOP holder], the value of CW[AC] shall be updated as follows before invoking the backoff procedure:

- If the QSRC[AC] or the QLRC[AC] for the QoS STA has reached dot11ShortRetryLimit or dot11LongRetryLimit, respectively, CW[AC] shall be reset to CW_{min}[AC].
- If the QSDRC[AC] or the QLDRC[AC] for the QoS STA in which dot11RobustAVStreamingImplemented is true has reached dot11ShortDEIRetryLimit or dot11LongDEIRetryLimit, respectively, CW[AC] shall be reset to CW_{min}[AC].
- Otherwise,
 - If CW[AC] is less than CW_{max}[AC], CW[AC] shall be set to the value $(CW[AC] + 1) * 2 - 1$.
 - If CW[AC] is equal to CW_{max}[AC], CW[AC] shall remain unchanged for the remainder of any retries.

The backoff timer is set to an integer value chosen randomly with a uniform distribution taking values in the range [0, CW[AC]] inclusive.

All backoff slots occur following an AIFS[AC] period during which the medium is determined to be idle on the primary channel for the duration of the AIFS[AC] period, or following an EIFS – DIFS + AIFS[AC] period during which the medium is determined to be idle on the primary channel for the duration of the EIFS – DIFS + AIFS[AC] period, as appropriate (see 9.3.2.3), except as defined in 9.19.2.3, which allows the medium to be busy during the initial aSIFSTime of this period under certain conditions.

~~If the backoff procedure is invoked following the transmission of a 40 MHz mask PPDU, the backoff counter shall be decremented based on a medium busy indication that ignores activity in the secondary channel. Additional 40 MHz mask PPDU backoff rules are found in 10.15.9.~~

9.19.2.6 Retransmit procedures

9.19.2.6.1 General

Change the second paragraph of 9.19.2.6.1 as follows:

QSRC[AC] shall be incremented every time transmission of an A-MPDU or frame of length less than or equal to dot11RTSThreshold fails, regardless of the presence or value of the DEI field. When dot11RobustAVStreamingImplemented is true, QSDRC[AC] shall be incremented every time transmission of an A-MPDU or frame in which the HT variant HT Control field is present, the DEI field is equal to 1, and

the length of the frame is less than or equal to dot11RTSThreshold fails. This short retry count and the QoS STA QSRC[AC] shall be reset when an A-MPDU or frame of length less than or equal to dot11RTSThreshold succeeds. When dot11RobustAVStreamingImplemented is true, the QSDRC[AC] shall be reset when an A-MPDU or frame of length less than or equal to dot11RTSThreshold succeeds, regardless of the presence or value of the DEI field.

Change the fourth paragraph of 9.19.2.6.1 as follows:

QLRC[AC] shall be incremented every time transmission of an A-MPDU or frame of length greater than or equal to dot11RTSThreshold fails, regardless of the presence or value of the DEI field. This long retry count and the QLRC[AC] shall be reset when an A-MPDU or frame of length greater than dot11RTSThreshold succeeds. When dot11RobustAVStreamingImplemented is true, QLDRC[AC] shall be incremented every time transmission fails for an A-MPDU or frame of length greater than dot11RTSThreshold in which the HT variant HT Control field is present and the DEI field is equal to 1. The QLDRC[AC] shall be reset when an A-MPDU or frame of length greater than dot11RTSThreshold succeeds, regardless of the presence or value of the DEI field.

9.19.2.7 Truncation of a TXOP

Change the fourth paragraph of 9.19.2.7, insert a new note after the existing note after this paragraph, and number the existing note “1” as follows:

In a non-DMG network, a STA shall interpret the reception of a CF-End frame as a NAV reset, i.e., it resets its NAV timer to 0 at the end of the PPDU containing this frame. After receiving a CF-End frame with a matching BSSID(TA) without comparing Individual/Group bit, an AP may respond by transmitting a CF-End frame after SIFS.

NOTE 1—The transmission of a single CF-End frame by the TXOP holder resets the NAV of STAs hearing the TXOP holder. There may be STAs that could hear the TXOP responder that had set their NAV that do not hear this NAV reset. Those STAs are prevented from contending for the medium until the original NAV reservation expires.

NOTE 2—A CF-End sent by a non-AP VHT STA that is a member of a VHT BSS can include the TXVECTOR parameter CH_BANDWIDTH_IN_NON_HT as defined in 9.7.6.6 in case it elicits a CF-End response.

Insert the following subclause, 9.19.2.8 (including Table 9-8a), after 9.19.2.7:

9.19.2.8 EDCA channel access in a VHT BSS

If the MAC receives a PHY-CCA.indication primitive with the channel-list parameter present, the channels considered idle are defined in Table 9-8a.

Table 9-8a—Channels indicated idle by the channel-list parameter

PHY-CCA.indication channel-list element	Idle channels
primary	None
secondary	Primary 20 MHz channel
secondary40	Primary 20 MHz channel and secondary 20 MHz channel
secondary80	Primary 20 MHz channel, secondary 20 MHz channel, and secondary 40 MHz channel

In the following description, the CCA is sampled according to the timing relationships defined in 9.3.7. Slot boundaries are determined solely by activity on the primary channel. “Channel idle for an interval of PIFS” means that whenever CCA is sampled during the period of PIFS that ends at the start of transmission, the CCA for that channel was determined to be idle.

If a STA is permitted to begin a TXOP (as defined in 9.19.2.3) and the STA has at least one MSDU pending for transmission for the AC of the permitted TXOP, the STA shall perform exactly one of the following steps:

- a) Transmit a 160 MHz or 80+80 MHz mask PPDU if the secondary channel, the secondary 40 MHz channel, and the secondary 80 MHz channel were idle during an interval of PIFS immediately preceding the start of the TXOP.
- b) Transmit an 80 MHz mask PPDU on the primary 80 MHz channel if both the secondary channel and the secondary 40 MHz channel were idle during an interval of PIFS immediately preceding the start of the TXOP.
- c) Transmit a 40 MHz mask PPDU on the primary 40 MHz channel if the secondary channel was idle during an interval of PIFS immediately preceding the start of the TXOP.
- d) Transmit a 20 MHz mask PPDU on the primary 20 MHz channel.
- e) Restart the channel access attempt by invoking the backoff procedure as specified in 9.19.2 as though the medium is busy on the primary channel as indicated by either physical or virtual CS and the backoff timer has a value of 0.

NOTE 1—In the case of rule e), the STA selects a new random number using the current value of CW[AC], and the retry counters are not updated (as described in 9.19.2.5; backoff procedure invoked for event a)).

NOTE 2—For both an HT and a VHT STA, an EDCA TXOP is obtained based on activity on the primary channel (see 9.19.2.3). The width of transmission is determined by the CCA status of the non-primary channels during the PIFS interval before transmission (see 9.19.2.4).

9.19.3 HCCA

9.19.3.2 HCCA procedure

9.19.3.2.4 Recovery from the absence of an expected reception

Change the second paragraph of 9.19.3.2.4 as follows:

The beginning of reception of an expected response is detected by the occurrence of PHYCCA.indication(BUSY, channel-list) primitive at the STA that is expecting the response where the channel-list parameter is absent or, if present, includes “primary”.

- The channel-list parameter is absent, or
- The channel-list is equal to {primary} and the HT STA expected to transmit the expected response supports 20 MHz operation only, or
- The channel-list is equal to either {primary} or {primary, secondary} and the HT STA expected to transmit the expected response supports both 20 MHz and 40 MHz operation (see 10.15.2).

9.19.3.5 HCCA transfer rules

9.19.3.5.3 Use of RTS/CTS

Insert the following subclause, 9.19.3.5.4, after 9.19.3.5.3:

9.19.3.5.4 HCCA transfer rules for a VHT STA

A VHT STA in a BSS that supports multiple channel widths is granted a TXOP for a specified duration and for a channel width that is equal to the channel width of the frame containing the QoS CF-Poll.

9.21 Block Acknowledgment (Block Ack)

9.21.10 GCR Block Ack

9.21.10.3 GCR Block Ack BlockAckReq and BlockAck frame exchanges

Change the eighth paragraph of 9.21.10.3 as follows:

The beginning of reception of an expected response to a BlockAckRequest frame is detected by the occurrence of a PHY-CCA.indication(BUSY, channel-list) primitive at the STA that is expecting the response where the channel-list parameter is absent or, if present, includes “primary.” ~~one of the following conditions exists:~~

- ~~The channel list parameter is absent; or~~
- ~~The channel list is equal to {primary}, and the HT STA expected to transmit the expected response supports 20 MHz operation only; or~~
- ~~The channel list is equal to either {primary} or {primary, secondary}, and the HT STA expected to transmit the expected response supports both 20 MHz and 40 MHz operation (see 10.15.2).~~

9.23 Protection mechanisms

9.23.5 L-SIG TXOP protection

9.23.5.3 L-SIG TXOP protection rules at the TXOP responder

Insert the following paragraph at the end of 9.23.5.3:

A VHT STA shall set the HT Capabilities element HT Capabilities Info field L-SIG TXOP Protection Support subfield to 0 during association and reassociation. A VHT AP shall set the HT Operation element HT Operation Information field L-SIG TXOP Protection Full Support subfield to 0.

Insert the following subclause, 9.23.6, after 9.23.5.4:

9.23.6 Protection Rules for VHT STAs

A VHT STA is subject to all of the rules for HT STAs that apply to its operating band. This defines protection accorded to non-HT STAs.

9.25 Reverse Direction Protocol

9.25.1 Reverse direction (RD) exchange sequence

Insert the following note after the existing note after the first paragraph of 9.25.1, and number the existing note “1”:

NOTE 2—If the RD responder is a VHT AP, the RD response burst can contain VHT MU PPDU that might have TXVECTOR parameter NUM_USERS > 1.

9.25.3 Rules for RD initiator

Change the third paragraph of 9.25.3 as follows:

Transmission of a +HTC/DMG frame by an RD initiator with the RDG/More PPDU subfield equal to 1 (either transmitted as a non-A-MPDU frame or VHT single MPDU or within an A-MPDU) indicates that the duration indicated by the Duration/ID field is available for the RD response burst and RD initiator final PPDU (if present).

Change the last paragraph of 9.25.3 as follows:

A STA that transmits a QoS +CF-ACK data frame according to the rules in 9.19.3.5 may also include an RDG in that frame provided that

- It is a non-A-MPDU frame or VHT single MPDU, and
- The target of the +CF-ACK is equal to the Address 1 field of the frame.

9.25.4 Rules for responder

Change the third paragraph of 9.25.4 as follows:

An RD responder that is a non-DMG STA may transmit a +CF-ACK non-A-MPDU frame or VHT single MPDU in response to a ~~non-A-MPDU~~ QoS Data +HTC non-A-MPDU frame or VHT single MPDU that has the Ack Policy field equal to Normal Ack and the RDG/More PPDU subfield equal to 1.

Change the seventh paragraph of 9.25.4 as follows:

During an RDG, any PPDU transmitted by an RD responder shall contain at least one MPDU with an Address 1 field that matches the MAC address of the RD initiator, and the inclusion of traffic to STAs other than the RD initiator in a VHT MU PPDU shall not increase the duration of the VHT MU PPDU beyond that required to transport the traffic to the RD initiator. The RD responder shall not transmit any frames causing a response after SIFS with an Address 1 field that does not match the MAC address of the RD initiator. The RD responder shall not transmit any PPDUs with a CH BANDWIDTH that is wider than the CH BANDWIDTH of the PPDU containing the frame(s) that delivered the RD grant.

9.26 PSMP operation

9.26.1 Frame transmission mechanism during PSMP

9.26.1.2 PSMP downlink transmission (PSMP-DTT)

Change the third paragraph of 9.26.1.2 as follows:

The PSMP-DTT may contain one or more PPDUs, each of which may contain either an A-MPDU or a single ~~(non-A-MPDU)~~ MPDU. Data may be transmitted using either format, provided that the format is supported by both the transmitter and the receiver.

9.27 Sounding PPDU

Insert the following paragraph at the beginning of 9.27:

The behavior described in this subclause is specific to the use of the HT variant HT Control field.

Change the now third paragraph through the beginning of the fifth paragraph of 9.27 as follows:

A STA transmits sounding PPDU when it operates in the following roles:

- MFB requester (see 9.28.2)
- HT beamformee ~~Beamformee~~ responding to a training request, calibration initiator, or responder involved in implicit transmit beamforming (see 9.29.2.2, 9.29.2.3, and 9.29.2.4)
- HT beamformer ~~Beamformer~~ involved in explicit transmit beamforming (see 9.29.3)
- ASEL transmitter and ASEL sounding-capable transmitter involved in ASEL (see 9.30.2)

A STA receives sounding PPDU when it operates in the following roles:

- MFB responder (see 9.28.2)
- HT beamformer ~~Beamformer~~ sending a training request, calibration initiator, or responder involved in implicit transmit beamforming (see 9.29.2.2, 9.29.2.3, and 9.29.2.4)
- HT beamformee ~~Beamformee~~ involved in explicit transmit beamforming (see 9.29.3)
- Transmit ASEL responder and ASEL receiver involved in ASEL (see 9.30.2)

When transmitting a sounding PPDU, the transmitting STA follows the rules stated below to determine the maximum number of space-time streams for which channel coefficients can be simultaneously estimated:

- When transmitting a sounding PPDU that
 - Contains a +HTC frame with the MRQ subfield equal to 1, or
 - Is sent as a response to a +HTC frame with the TRQ field equal to 1, or
 - Is sent during a calibration sounding exchange, or
 - Is sent by an HT beamformer involved in explicit transmit beamforming, or
 - Is sent in transmit or receive ASEL exchanges,

9.28 Link adaptation

Change the title of 9.28.2 as follows:

9.28.2 Link adaptation using the HT variant HT Control field

Insert the following paragraph at the beginning of 9.28.2:

The behavior described in this subclause is specific to the HT variant HT Control field.

Change the now fifth paragraph of 9.28.2 as follows:

An MFB requester shall transmit +HTC frames with the MRQ subfield equal to 1 in one of the following ways:

- Within a sounding PPDU, or
- With the HT NDP Announcement subfield in the +HTC frame set to 1 and following the +HTC frame by an NDP transmission

Change the now seventh paragraph of 9.28.2 as follows:

An MFB-capable STA (identified by the MCS Feedback field in Extended HT Capabilities Info field equal to 3) shall support the following:

- MFB estimate computation and feedback on the receipt of MRQ (MRQ=1 in +HTC) in a sounding PPDU for which the RXVECTOR NUM_EXTEN_SS parameter contains 0 in the PHYRXSTART.indication primitive.
- MFB estimate computation and feedback on the receipt of MRQ (MRQ=1 in +HTC) in a staggered sounding PPDU if this STA declares support for receive staggered sounding by setting the Receive Staggered Sounding Capable subfield of the Transmit Beamforming Capabilities field to 1.
- MFB estimate computation and feedback on the receipt of NDP (see 9.31) if this STA declares support for receiving NDP sounding by setting the Receive NDP Capable subfield of the Transmit Beamforming Capabilities field to 1. The MFB requester shall set the MRQ subfield to 1 in the frame where the HT NDP Announcement subfield is equal to 1.

Change the last paragraph of 9.28.2 as follows:

If an HT beamformer transmits a PPDU with the TXVECTOR EXPANSION_MAT_TYPE set to either COMPRESSED_SV or NON_COMPRESSED_SV, it should use the recommended MCS associated with those matrices reported in a Noncompressed Beamforming frame or a Compressed Beamforming frame.

Insert the following subclause, 9.28.3, after 9.28.2:**9.28.3 Link adaptation using the VHT variant HT Control field**

The behavior described in this subclause is specific to the VHT variant HT Control field.

A STA that supports VHT link adaptation using the VHT variant HT Control field shall set the VHT Link Adaptation Capable subfield in the VHT Capabilities Info field in the VHT Capabilities element to Unsolicited or Both, depending on its specific link adaptation feedback capability. A STA shall not send an MRQ to STAs that have not set VHT Link Adaptation Capable subfield to Both in the VHT Capabilities Info field of the VHT Capabilities element. A STA whose VHT Link Adaptation Capable subfield of the VHT Capabilities Info field of the VHT Capabilities element is either set to Unsolicited or Both may transmit unsolicited MFB in any frame that contains a VHT variant HT Control field.

The MFB requester may set the MRQ field to 1 in the VHT variant HT Control field of a frame to request a STA to provide link adaptation feedback. In each request the MFB requester shall set the MSI/STBC field to a value in the ranges 0 to 6, 0 to 2, or 0 to 3, depending on the settings in the Unsolicited MFB and STBC fields (see 8.2.4.6.3). The choice of MSI value is implementation dependent.

The appearance of more than one instance of a VHT variant HT Control field with the MRQ field equal to 1 within a single PPDU shall be interpreted by the receiver as a single request for link adaptation feedback.

An MFB responder that has set the VHT Link Adaptation Capable subfield to Both in the VHT Capabilities Info field of the VHT Capabilities element shall support both of the following:

- Computation and feedback of the MFB estimate on the receipt of an MFB request (MRQ equal to 1 in the VHT variant HT Control field) in a PPDU that is not a VHT NDP Announcement frame
- Computation and feedback of the MFB estimate on the receipt of an MFB request (MRQ equal to 1 in VHT variant HT Control field) in a VHT NDP Announcement frame and the receipt of VHT NDPs (see 9.31) if this STA set the SU Beamformee Capable subfield of the VHT Capabilities Info field of the VHT Capabilities element to 1

On receipt of a VHT variant HT Control field with the MRQ field equal to 1, an MFB responder computes the VHT-MCS, NUM_STS, and SNR estimates based on the PPDU carrying the MRQ or, in the case of a VHT NDP Announcement frame carrying the MRQ, based on the subsequent VHT NDP. The MFB responder labels the result of this computation with the MSI value from the VHT variant HT Control field in the received frame carrying the MRQ. The MFB responder may include the received MSI value in the MFSI field of the corresponding response frame. In the case of a delayed response, this allows the MFB requester to associate the MFB with the soliciting MRQ.

An MFB responder that sends a solicited MFB shall set the Unsolicited MFB subfield in VHT variant HT Control field to 0.

The MFB responder may send a solicited response frame with any of the following combinations of VHT-MCS, NUM_STS, and MFSI:

- VHT-MCS = 15, NUM_STS = 7 in the MFB subfield, MFSI = 7: no information is provided for the immediately preceding request or for any other pending request. This combination is used when the responder is required to include a VHT variant HT Control field due to other protocols that use this field (e.g., the Reverse Direction Protocol) and when no MFB is available. It has no effect on the status of any pending MRQ.
- VHT-MCS = 15, NUM_STS = 7 in the MFB subfield, MFSI in the range 0 to 6: the responder is not now providing, and will never provide, feedback for the request that had the MSI value that matches the MFSI value.
- VHT-MCS = valid value, NUM_STS = valid value in the MFB subfield, MFSI in the range 0 to 6: the responder is providing feedback for the request that had the MSI value that matches the MFSI value.

An MFB responder that discards or abandons the MFB estimates computed in response to an MRQ may indicate that it has done so by setting the VHT-MCS to 15 and NUM_STS to 7 in the MFB subfield in the next frame addressed to the MFB requester that includes the VHT variant HT Control field. The value of the MFSI is set to the value of the MSI/STBC subfield of the frame that contains an MRQ for which the computation was abandoned, regardless of whether the MSI/STBC subfield contains an MSI or a Compressed MSI and STBC Indication subfields.

The STA receiving MFB may use the received MFB to compute the appropriate VHT-MCS, SNR, and NUM_STS.

A STA sending unsolicited MFB feedback using the VHT variant HT Control field shall set the Unsolicited MFB subfield to 1.

Unsolicited VHT-MCS, NUM_STS, BW, and SNR estimates reported in the MFB subfield of a VHT variant HT Control field sent by a STA are computed based on the most recent PPDU received by the STA that matches the description indicated by the GID-L, GID-H, Coding Type, STBC Indication, and FB Tx Type fields in the same VHT variant HT Control field.

In an unsolicited MFB response the GID-L, GID-H, Coding Type, STBC Indication, FB Tx Type, and BW fields are set according to the RXVECTOR parameters of the received PPDU from which the VHT-MCS, SNR, BW, and NUM_STS are estimated, as follows:

- If the VHT-MCS, SNR, BW, and NUM_STS are estimated from a VHT MU PPDU, then the GID-L field is set to the 3 least significant bits and the GID-H field to the 3 most significant bits of the parameter GROUP_ID.
- If the VHT-MCS, SNR, BW, and NUM_STS are estimated from an SU PPDU, then the GID-L field and GID-H field are set to all ones.

- The Coding Type field is set to 0 if the parameter FEC_CODING is equal to BCC_CODING and set to 1 if equal to LDPC_CODING.
- The STBC Indication field is set to 1 if the parameter STBC is equal to 1 and set to 0 if the STBC parameter is equal to 0.
- The FB TX Type field is set to 1 if the parameter BEAMFORMED is equal to 1 and set to 0 if equal to 0.
- The BW field shall indicate a bandwidth equal to or less than the bandwidth indicated by the parameter CH_BANDWIDTH.

In an MFB response solicited by an MRQ that was not carried in a VHT NDP Announcement frame, the MFB is computed based on RXVECTOR parameters CH_BANDWIDTH, GROUP_ID, NUM_STS, FEC_CODING, BEAMFORMED, and STBC of the received PPDU that carried the MRQ and might additionally be based on other factors that are not part of the RXVECTOR. The NUM_STS subfield of the MFB subfield of VHT variant HT Control field shall be set to an equal or smaller value than the RXVECTOR parameter NUM_STS of the received PPDU that triggered the MRQ.

If the MFB is in the same MPDU as a VHT Compressed Beamforming frame, the MFB responder shall estimate the recommended MFB under the assumption that the beamformer will use the steering matrices contained therein for performing an SU beamformed transmission. In this case the value of the NUM_STS field in the MFB subfield of the VHT variant HT Control field shall be the same as the value of the Nc Index field in the VHT MIMO Control field of the VHT Compressed Beamforming frame and, if the MFB is unsolicited, the Coding Type shall be set to BCC and the FB Tx Type shall be set to 0. Additionally, MFB estimate shall be based on the bandwidth indicated by the Channel Width subfield of the VHT MIMO Control field of the VHT Compressed Beamforming frame. In this case the SNR and BW subfields are reserved and set to 0.

If an unsolicited MFB is not in the same MPDU as a VHT Compressed Beamforming frame, the NUM_STS subfield of the MFB subfield of the VHT variant HT Control field shall be set to an equal or smaller value than the RXVECTOR parameter NUM_STS of the received PPDU from which the MFB parameters are estimated.

If the MFB requester sends the MRQ in a VHT NDP Announcement frame, then the MFB responder shall include the corresponding MFB in (all of) the VHT Compressed Beamforming frame(s) sent in response to the same VHT NDP Announcement frame and NDP sequence.

If the value of the NUM_STS subfield of the MFB field (solicited or unsolicited) is a smaller value than the RXVECTOR parameter NUM_STS of the received PPDU on which the MFB is based, the MFB responder shall estimate the recommended VHT-MCS under the assumption that the MFB requester will transmit the first N_{STS} space-time streams in the corresponding PPDU carrying MRQ. If the MFB is based on an SU PPDU the first N_{STS} space-time streams correspond to columns 1, ..., N_{STS} of the spatial mapping matrix Q . If the MFB is based on a VHT MU PPDU, then for the user u the first N_{STS} space-time streams correspond to columns M_u+1 , ..., $M_u+N_{STS,u}$ of the spatial mapping matrix Q (M_u is defined in 22.3.10.11.1).

A VHT NDP Announcement frame that contains multiple STA Info fields and that contains a VHT format of HT Control field with the MRQ subfield equal to 1 solicits an MFB response from all the STAs listed in the STA Info fields.

When the MFB requester sets the MRQ subfield to 1 and sets the MSI/STBC subfield to a value that matches the MSI/STBC subfield value of a previous request for which the responder has not yet provided feedback, the responder shall discard or abandon the computation for the MRQ that corresponds to the previous use of that MSI/STBC subfield value and start a new computation based on the new request.

A STA may respond immediately to a current request for MFB with a frame containing an MFSI field value and an MFB field value that correspond to a request that precedes the current request.

Bidirectional request/responses are supported. A STA may act as both the MFB requester for one direction of a duplex link and the MFB responder for the other direction and include both an MRQ and an MFB in the same VHT variant HT Control field.

9.29 Transmit beamforming

Change 9.29.1 (including the subclause title) as follows:

9.29.1 ~~General~~ HT steering matrix calculations

In order for an HT beamformer to calculate an appropriate steering matrix for transmit spatial processing when transmitting to a specific HT beamformee, the HT beamformer needs to have an accurate estimate of the channel over which it is transmitting. Two methods of calculation are defined as follows:

- *Implicit feedback:* When using implicit feedback, the beamformer receives long training symbols transmitted by the HT beamformee, which allow the MIMO channel between the HT beamformee and HT beamformer to be estimated. If the channel is reciprocal, the HT beamformer can use the training symbols that it receives from the HT beamformee to make a channel estimate suitable for computing the transmit steering matrix. Generally, calibrated radios in MIMO systems can improve reciprocity. See 9.29.2.
- *Explicit feedback:* When using explicit feedback, the HT beamformee makes a direct estimate of the channel from training symbols sent to the HT beamformee by the HT beamformer. The HT beamformee may prepare CSI or steering feedback based on an observation of these training symbols. The HT beamformee quantizes the feedback and sends it to the HT beamformer. The HT beamformer can use the feedback as the basis for determining transmit steering vectors. See 9.29.3.

An HT STA shall not transmit a PPDU with the TXVECTOR EXPANSION_MAT parameter present if dot11BeamFormingOptionActivated is false.

Change the title of 9.29.2 as follows:

9.29.2 HT transmit beamforming with implicit feedback

9.29.2.1 General

Change 9.29.2.1 as follows:

The procedures for HT transmit beamforming with implicit feedback use only HT and non-HT PPDUs, and the HT Control field, when present, is the HT variant HT Control field.

Transmit beamforming with implicit feedback can operate in a unidirectional or bidirectional manner. In unidirectional implicit transmit beamforming, only the HT beamformer sends beamformed transmissions. In bidirectional implicit transmit beamforming, both STAs send beamformed transmissions, i.e., a STA may act as both HT beamformer and HT beamformee.

Calibration of receive/transmit chains should be done to improve performance of transmit beamforming using implicit feedback. Over-the-air calibration is described in 9.29.2.4. For implicit transmit beamforming, only the HT beamformer, which is sending the beamformed transmissions, needs to be calibrated.

A STA that advertises itself as being capable of being an HT beamformer and/or HT beamformee using implicit feedback shall support the requirements in Table 9-11.

Table 9-11 remains unchanged.

A STA that performs one of the roles related to transmit beamforming with implicit feedback shall support the associated capabilities shown in Table 9-12.

Table 9-9—Transmit beamforming support required with implicit feedback

Role	Required support
<u>HT</u> beamformee: A receiver of transmit beamformed PPDU	Shall transmit sounding PPDU as a response to TRQ=1.
Beamformer: A transmitter of beamformed PPDU	Can receive sounding PPDU. Can compute steering matrices from MIMO channel estimates obtained from long training symbols in sounding PPDU received from the <u>HT</u> beamformee.
A responder in a calibration exchange	Can receive and transmit sounding PPDU. Can respond with a CSI frame that contains channel measurement information obtained during reception of a sounding PPDU.
An initiator in a calibration exchange	Can receive and transmit sounding PPDU. Can receive a CSI frame sent by a calibration responder.

When an HT beamformee transmits a sounding PPDU, the SOUNDING parameter in the TXVECTOR in the PHYTXSTART.request primitive shall be set to SOUNDING. If the HT beamformee is capable of implicit transmit beamforming and the HT beamformer is capable of receiving implicit transmit beamforming, the sounding PPDU from the HT beamformee may be steered.

A PPDU containing one or more +HTC MPDU in which the TRQ field is equal to 1 shall not be sent to a STA that sets the Implicit Transmit Beamforming Receiving Capable subfield of the Transmit Beamforming field of the HT Capabilities element to 0.

If a PPDU containing one or more +HTC MPDU in which the TRQ field is equal to 1 requires an immediate response, either the response from the HT beamformee shall be included in a sounding PPDU, or the HT NDP Announcement subfield of the HT Control field shall be set to 1 and the PPDU shall be followed by an NDP. If the PPDU in which the TRQ field is equal to 1 does not require an immediate response, either the HT beamformee shall transmit a sounding PPDU in the next TXOP obtained by the HT beamformee, or the HT beamformee shall transmit a PPDU in the next TXOP obtained by the HT beamformee in which the HT NDP Announcement subfield of the HT Control field is set to 1 and that PPDU shall be followed by an NDP. The use of NDP as a sounding PPDU is described in 9.31.

NOTE—A STA that acts as an HT beamformer using implicit feedback expects to receive a sounding PPDU in response to a training request. The STA can compute steering matrices from the channel estimates obtained from the received sounding PPDU.

At the end of the TXOP, the final PPDU from the HT beamformer shall not have the TRQ field set to 1 in a frame that requests an immediate response if there is not enough time left in the TXOP for the HT beamformee to transmit the longest valid sounding PPDU with its response.

9.29.2.3 Bidirectional implicit transmit beamforming

Change the first paragraph of 9.29.2.3 as follows:

Figure 9-36 shows an example of a PPDU exchange used in bidirectional implicit transmit beamforming, using the Clause 20 PHY. In this example, sounding PPDUs are used that carry MPDUs. STA A initiates the frame exchange, and STA A and STA B alternate in the roles of HT beamformer and HT beamformee.

9.29.2.4 Calibration

9.29.2.4.1 Introduction

Change the second paragraph of 9.29.2.4.1 as follows:

A STA acting as a HT beamformer should be calibrated to maximize performance. A STA acting only as a HT beamformee does not need to be calibrated. If calibration is desired, it is performed using the over-the-air calibration procedure described below.

9.29.2.4.3 Sounding exchange for calibration

Change “NDP Announcement” to “HT NDP Announcement” one instance each in Figure 9-38 and Figure 9-39.

Change the 13th paragraph of 9.29.2.4.3 as follows:

NDP transmission within a calibration procedure follows the rules defined in 9.31.1. STA A transmits a Calibration Start frame (i.e., with the Calibration Position subfield set to 1) with the HT NDP Announcement subfield set to 1 and CSI/Steering subfield of the HT Control field set to 1. Only the current TXOP holder may set both the Calibration Position and HT NDP Announcement subfields to 1. This frame initiates a calibration procedure.

9.29.2.4.4 CSI reporting for calibration

Change the fourth paragraph of 9.29.2.4.4 as follows:

STA B should finish transmission of the first CSI frame within aMaxCSIMatricesReportDelay (in milliseconds) after the reception of the frame containing the CSI feedback request or HT NDP announcement.

9.29.3 Explicit feedback beamforming

Insert the following paragraph at the beginning of 9.29.3:

The procedures for explicit feedback beamforming use only HT and non-HT PPDUs, and the HT Control field, when present, is the HT variant HT Control field.

Change all occurrences in 9.29.3 (except for the new paragraph below) of “beamformer” to “HT beamformer” (31 times) and “beamformee” to “HT beamformee” (43 times, including in Table 9-13 and Table 9-14).

Insert the following paragraph after the now 14th paragraph (“An HT beamformee that sets the Explicit Transmit Beamforming CSI Feedback field ...”) of 9.29.3:

The value of N_r within an explicit Beamforming feedback frame transmitted by a VHT beamformee will not exceed the value indicated in the Beamformee STS Capability subfield of the VHT Capabilities element.

Insert the following subclause, 9.29.4, after 9.29.3:

9.29.4 VHT MU beamforming

An MU beamformer may transmit a VHT MU PPDU with a single nonzero TXVECTOR parameter NUM_STS[p], where $0 \leq p \leq 3$.

An MU beamformer shall not transmit a VHT MU PPDU with a nonzero TXVECTOR parameter NUM_STS[p], where $0 \leq p \leq 3$, to a STA whose MU Beamformee Capable field is equal to 0.

When transmitting a VHT MU PPDU, an MU beamformer shall order the per-user arrays of TXVECTOR parameters so that the per-user USER_POSITION array is in ascending order.

9.30 Antenna selection (ASEL)

9.30.1 Introduction

Insert the following paragraph at the beginning of 9.30.1:

The procedures for antenna selection use only HT and non-HT PPDUs, and the HT Control field, when present, is the HT variant HT Control field.

9.31 Null data packet (NDP) sounding

Change 9.31.1 through 9.31.4 (including subclause titles) as follows:

9.31.1 NDP rules

Sounding may be accomplished using either staggered sounding PPDU or HT NDP, as described in 20.3.13 (HT Preamble format for sounding PPDUs). The MAC rules associated with sounding using HT NDP are described in 9.31.1 to 9.31.4.

An HT STA that has set the Receive NDP Capable field of its HT Capabilities element to 1 during association processes an HT NDP as a sounding packet if the destination of the sounding packet is determined to match itself as described in 9.31.3 and if the source of the sounding packet can be ascertained as described in 9.31.4.

An RXVECTOR LENGTH parameter equal to 0 indicates that the PPDU is an HT NDP.

A STA that is a TXOP holder or an RD responder shall not set both the HT NDP Announcement and RDG/More PPDU subfields to 1 simultaneously. The Calibration Position subfield shall not be set to any value except 0 and 1 in any +HTC frame in a PPDU that is also an HT NDP announcement. The Calibration Position subfield shall be set to 0 in any +HTC frame in a PPDU that is an HT NDP announcement that also contains any +HTC frame with the MAI subfield equal to ASEL1. The Calibration Position subfield shall be set to 0 in all +HTC frames in a PPDU that is an HT NDP announcement and that contains any +HTC frame with the MRQ subfield equal to 1. The TRQ field shall be set to 0 in all +HTC frames in a PPDU that is an HT NDP announcement.

An NDP sequence contains at least one non-NDP PPDU and at least one HT NDP PPDU. Only one PPDU in the NDP sequence may contain an HT NDP announcement. An NDP sequence begins with an HT NDP

announcement. The NDP sequence ends at the end of the transmission of the last HT NDP PPDU that is announced by the HT NDP announcement. A STA that transmits the first PPDU of an NDP sequence is the NDP sequence owner. In the NDP sequence, only PPDUs carrying HT NDP and PPDUs carrying ~~non-A-MPDU~~ single MPDU control frames may follow the NDP sequence's starting PPDU.

A STA shall transmit only one HT NDP per HT NDP announcement, unless the HT NDP announcement includes a value in the ASEL Data subfield of the ASEL Command subfield of the HTC Control field that is greater than one. Each PPDU in an NDP sequence shall start a SIFS interval after end of the previous PPDU.

A STA shall not transmit a VHT NDP in a NDP sequence that contains an HT NDP announcement.

~~The +HTC field of a~~ A CTS frame that is a +HTC frame shall not contain the HT NDP Announcement subfield set to 1.

NOTE—A CTS frame cannot be used for HT NDP announcement: if the CTS frame is a response to an RTS frame, the optional NAV reset timeout that starts at the end of the RTS frame does not include the additional HT NDP and SIFS duration (see 9.3.2.5). Also, if the CTS were the first frame of an NDP sequence, it would not be possible to determine the destination address of the HT NDP.

A STA shall transmit an HT NDP as follows:

- a) A SIFS interval after sending a PPDU that is an HT NDP announcement and that does not contain an MPDU that requires an immediate response.
- b) A SIFS interval after successfully receiving a correctly formed and addressed immediate response to a PPDU that is an HT NDP announcement and that contains an MPDU that requires an immediate response.
- c) A SIFS interval after transmitting an HT NDP if the HT NDP announcement contains an ASEL Command subfield equal to TXASSI, TXASSI-CSI, or RXASSI and the ASEL Data subfield is equal to value greater than 0 and if the number of HT NDPs sent before this one is less than the value in the ASEL Data subfield + 1.

NOTE—The total number of sent HT NDPs is equal to the value of in the ASEL Data subfield + 1.

- d) A SIFS interval after receiving an HT NDP from a STA whose HT NDP announcement contained one or more +HTC frames with the Calibration Position subfield equal to 1, when the receiving STA supports transmitting sounding PPDUs for which more than one channel dimension can be estimated (i.e., more than one column of the MIMO channel matrix).

This rule enables the NDP receiver to know that it will receive an HT NDP and can determine the source and destination of the HT NDP. It enables the receiver and transmitter to know when the immediate response and HT NDP will be transmitted relative to the frame containing the HT NDP announcement indication.

A STA that has transmitted an HT NDP announcement in a frame that requires an immediate response and that does not receive the expected response shall terminate the NDP sequence at that point (i.e., the STA does not transmit an HT NDP in the current NDP sequence).

A STA that has received an HT NDP announcement in a +HTC with the Calibration Position equal to 1 or 2, and that does not receive the HT NDP PPDU expected shall terminate the NDP sequence at that point (i.e., does not transmit an HT NDP in the current NDP sequence) and not transmit any further frames that are a part of this calibration sequence shown in Step 1 of Figure 9-37 (Calibration procedure with NDP).

Feedback information generated from the reception of an HT NDP is transmitted using any of the feedback rules and signaling as appropriate, e.g., immediate or delayed.

9.31.2 Transmission of an HT NDP

A STA that transmits an HT NDP shall set the LENGTH, SOUNDING, STBC, MCS, and NUM_EXTEN_SS parameters of the TXVECTOR as specified in this subclause.

- LENGTH shall be set to 0.
- SOUNDING shall be set to SOUNDING.
- STBC shall be set to 0.
- MCS shall indicate two or more spatial streams.

The number of spatial streams sounded is indicated by the MCS parameter of the TXVECTOR and shall not exceed the limit indicated by the Channel Estimation Capability field in the Transmit Beamforming Capabilities field transmitted by the STA that is the intended receiver of the HT NDP. The MCS parameter may be set to any value, subject to the constraint of the previous sentence, regardless of the value of the Supported MCS Set field of the HT Capabilities field at either the transmitter or recipient of the HT NDP. A STA shall set the NUM_EXTEN_SS parameter of the TXVECTOR to 0 in the PHY-TXSTART.request primitive corresponding to an HT NDP transmission.

A STA shall not transmit an HT NDP announcement with a RA corresponding to another STA unless it has received an HT Capabilities element from the destination STA in which the Receive NDP Capable field is equal to 1.

9.31.3 Determination of HT NDP destination

The destination of an HT NDP is determined at the NDP receiver by examining the HT NDP announcement as follows:

- The destination of the first HT NDP in the NDP sequence is equal to the RA of any MPDU within HT NDP announcement.
- If Calibration Position subfield is equal to 1 in the HT NDP announcement at the NDP receiver, the destination of the second HT NDP is equal to the TA of that frame. Otherwise, the destination of the second and any subsequent HT NDPs is equal to the destination of the previous HT NDP.

See S.4 for an illustration of these rules.

9.31.4 Determination of HT NDP source

The source of an HT NDP is determined at the NDP receiver by examining the NDP sequence's starting PPDU as follows:

- If any MPDU within the HT NDP announcement contains two or more addresses, the source of the first HT NDP is equal to the TA of that frame.
- Otherwise (i.e., the HT NDP announcement contains one address), the source of the first HT NDP is equal to the RA of the MPDU to which the HT NDP announcement is a response.

If the Calibration Position subfield is equal to 1 in an MPDU in the HT NDP announcement, the source of the second HT NDP is equal to the RA of that MPDU. Otherwise, the source of the second and any subsequent HT NDPs is equal to the source of the previous NDP.

See S.4 for an illustration of these rules.

Insert the following subclauses, 9.31.5 to 9.31.6 (including Figure 9-41a and Figure 9-41b), after 9.31.4:

9.31.5 VHT sounding protocol

9.31.5.1 General

Transmit beamforming and DL-MU-MIMO require knowledge of the channel state to compute a steering matrix that is applied to the transmitted signal to optimize reception at one or more receivers. The STA transmitting using the steering matrix is called the VHT beamformer and a STA for which reception is optimized is called a VHT beamformee. An explicit feedback mechanism is used where the VHT beamformee directly measures the channel from the training symbols transmitted by the VHT beamformer and sends back a transformed estimate of the channel state to the VHT beamformer. The VHT beamformer then uses this estimate, perhaps combining estimates from multiple VHT beamformees, to derive the steering matrix.

If dot11VHTSUBeamformerOptionImplemented is true, a STA shall set the SU Beamformer Capable field in the VHT Capabilities element to 1. If dot11VHTSUBeamformeeOptionImplemented is true, a STA shall set the SU Beamformee Capable field in the VHT Capabilities element to 1.

If dot11VHTMUBeamformerOptionImplemented is true, a STA shall set the MU Beamformer Capable field in the VHT Capabilities element to 1. If dot11VHTMUBeamformeeOptionImplemented is true, a STA shall set the MU Beamformee Capable field in the VHT Capabilities element to 1.

If dot11VHTMUBeamformerOptionImplemented is true, a STA shall set dot11VHTSUBeamformerOptionImplemented to true. If dot11VHTMUBeamformeeOptionImplemented is true, a STA shall set dot11VHTSUBeamformeeOptionImplemented to true.

A STA is a VHT SU-only beamformer if it sets the SU Beamformer Capable field to 1 but sets the MU Beamformer Capable field to 0 in transmitted VHT Capabilities elements. A STA is an SU-only beamformee if it sets the SU Beamformee Capable field to 1 but sets the MU Beamformee Capable field to 0 in transmitted VHT Capabilities elements.

If dot11VHTSUBeamformerOptionImplemented is false, a STA shall not act in the role of a VHT beamformer. If dot11VHTSUBeamformeeOptionImplemented is false, a STA shall not act in the role of a VHT beamformee.

9.31.5.2 Rules for VHT sounding protocol sequences

A VHT beamformer shall initiate a sounding feedback sequence by transmitting a VHT NDP Announcement frame followed by a VHT NDP after a SIFS. The VHT beamformer shall include in the VHT NDP Announcement frame one STA Info field for each VHT beamformee that is expected to prepare VHT Compressed Beamforming feedback and shall identify the VHT beamformee by including the VHT beamformee's AID in the AID subfield of the STA Info field. The VHT NDP Announcement frame shall include at least one STA Info field.

NOTE—A STA that transmits a VHT NDP Announcement frame to a DLS or TDLS peer STA obtains the AID for the peer STA from the DLS Setup Request, DLS Setup Response, TDLS Setup Request, or TDLS Setup Response frame.

A VHT beamformer shall not transmit either a VHT NDP Announcement+HTC frame or a Beamforming Report Poll+HTC frame that contains an HT variant HT Control field.

A VHT NDP shall be transmitted only following a SIFS after a VHT NDP Announcement frame. A VHT NDP Announcement frame shall be followed by a VHT NDP after SIFS.

A VHT beamformer that has not received from a STA a VHT Capabilities element or where the last VHT Capabilities element received from the STA has the SU Beamformee Capable field set to 0 shall not transmit either of the following:

- AVHT NDP Announcement frame addressed to the STA or that includes the STA's AID in one of the STA Info fields
- A Beamforming Report Poll frame to the STA

A VHT beamformer that transmits a VHT NDP Announcement frame to a VHT SU-only beamformee shall include only one STA Info field in the VHT NDP Announcement frame and set the Feedback Type subfield of the STA Info field to SU.

If the VHT NDP Announcement frame includes more than one STA Info field, the RA of the VHT NDP Announcement frame shall be set to the broadcast address. If the VHT NDP Announcement frame includes a single STA Info field, the RA of the VHT NDP Announcement frame shall be set to the MAC address of the VHT beamformee.

A VHT NDP Announcement frame shall not include two or more STA Info fields with same value in the AID subfield.

A VHT beamformer that transmits a VHT NDP Announcement frame to a VHT beamformee that is an AP, mesh STA or STA that is a member of an IBSS, shall include a single STA Info field in the VHT NDP Announcement frame and shall set the AID field in the STA Info field to 0.

A VHT NDP Announcement frame with more than one STA Info field shall not carry a VHT variant HT Control field, unless all the STAs listed in the AID field of the STA Info fields have set +HTC-VHT Capable to 1 in the VHT Capabilities Info field.

A VHT beamformer that transmits a VHT NDP Announcement frame with more than one STA Info field should transmit any Beamforming Report Poll frames used to retrieve VHT Compressed Beamforming feedback from the intended VHT beamformees in the same TXOP. If the duration of the TXOP that contained the VHT NDP Announcement frame has insufficient duration to accommodate the transmission of all of the feedback reports, the VHT beamformer may poll for the remaining VHT Compressed Beamforming feedback in subsequent TXOPs.

NOTE—The transmission of the VHT NDP Announcement, VHT NDP, VHT Compressed Beamforming, and Beamforming Report Poll frames is subject to the rules in 9.19.2.4.

A VHT beamformer that sets the Feedback Type subfield of a STA Info field to MU shall set the Nc Index subfield of the same STA Info field to a value equal to or less than the minimum of both the following:

- The maximum number of supported spatial streams according to the corresponding VHT beamformee's Rx VHT-MCS Map subfield in the Supported VHT-MCS and NSS Set field
- The maximum number of supported spatial streams according to the Rx NSS subfield value in the Operating Mode field of the most recently received Operating Mode Notification frame or Operating Mode Notification element with the Rx NSS Type subfield equal to 0 from the corresponding VHT beamformee

A non-AP VHT beamformee that receives a VHT NDP Announcement frame from a VHT beamformer with which it is associated or has an established DLS or TDLS session and that contains the VHT beamformee's AID in the AID subfield of the first (or only) STA Info field and also receives a VHT NDP a SIFS after the VHT NDP Announcement frame shall transmit the PPDU containing its VHT Compressed Beamforming feedback a SIFS after the VHT NDP. A VHT beamformee that is an AP, mesh STA, or STA that is a member of an IBSS, that receives a VHT NDP Announcement frame with the RA matching its MAC address and the AID subfield of the only STA Info field set to 0, and that also receives a VHT NDP a SIFS

after the VHT NDP Announcement frame shall transmit the PPDU containing its VHT Compressed Beamforming feedback a SIFS after the VHT NDP. The TXVECTOR parameter CH_BANDWIDTH of the PPDU containing the VHT Compressed Beamforming feedback shall be set to indicate a bandwidth not wider than that indicated in the RXVECTOR parameter CH_BANDWIDTH of the received VHT NDP frame. A STA ignores received VHT NDP Announcement, VHT NDP, and Beamforming Report Poll frames if dot11VHTSUBeamformeeImplemented is false.

A VHT beamformee shall indicate the maximum number of space-time streams it can receive in a VHT NDP in the Beamformee STS Capability field. If the beamformee is a non-AP STA, this shall also be the maximum total number of space-time streams that the STA can receive in a VHT MU PPDU.

An example of the VHT sounding protocol with a single VHT beamformee is shown in Figure 9-41a.

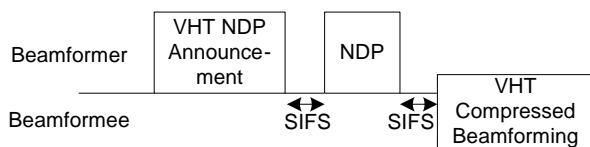

Figure 9-41a—Example of the sounding protocol with a single VHT beamformee

A non-AP VHT beamformee that receives a VHT NDP Announcement frame from a VHT beamformer with which it is associated or has an established DLS or TDLS session and that contains the VHT beamformee’s AID in the AID subfield of a STA Info field that is not the first STA Info field shall transmit its VHT Compressed Beamforming feedback a SIFS after receiving a Beamforming Report Poll with RA matching its MAC address and a non-bandwidth signaling TA obtained from the TA field matching the MAC address of the VHT beamformer. If the RXVECTOR parameter CH_BANDWIDTH_IN_NON_HT of the received Beamforming Report Poll frame is valid, the TXVECTOR parameter CH_BANDWIDTH of the PPDU containing the VHT Compressed Beamforming feedback shall be set to indicate a bandwidth not wider than that indicated by the RXVECTOR parameter CH_BANDWIDTH_IN_NON_HT of the Beamforming Report Poll frame; otherwise, the TXVECTOR parameter CH_BANDWIDTH of the PPDU containing VHT Compressed Beamforming feedback shall be set to indicate a bandwidth not wider than that indicated by the RXVECTOR parameter CH_BANDWIDTH of the Beamforming Report Poll frame.

An example of the VHT sounding protocol with more than one VHT beamformee is shown in Figure 9-41b.

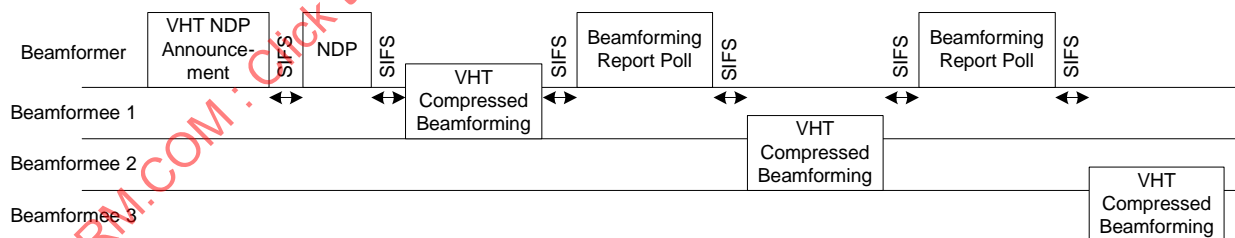

Figure 9-41b—Example of the sounding protocol with more than one VHT beamformee

The RA field of the VHT Compressed Beamforming frame(s) of the VHT Compressed Beamforming feedback shall be set to a non-bandwidth signaling TA obtained from the TA field of the VHT NDP Announcement frame or the Beamforming Report Poll frame to which this VHT Compressed Beamforming feedback is a response.

If the VHT Beamformee is transmitting VHT Compressed Beamforming frame(s) a SIFS after the VHT NDP, then the VHT Compressed Beamforming frame(s) shall include the VHT Compressed Beamforming Report information and, for the case of MU feedback, the MU Exclusive Beamforming Report information.

A VHT beamformee that transmits a VHT Compressed Beamforming frame shall set the Feedback Type field in the VHT MIMO Control field to the same value as the Feedback Type field in the corresponding STA Info field in the VHT NDP Announcement frame. If the Feedback Type field indicates MU, the STA shall send a VHT Compressed Beamforming frame with the Nc Index field value in the VHT MIMO Control field equal to the minimum of all the following:

- The Nc Index field value in the corresponding STA Info field in the VHT NDP Announcement frame
- The maximum number of supported spatial streams according to its Rx VHT-MCS Map subfield in the Supported VHT-MCS and NSS Set field
- The maximum number of supported spatial streams according to its Rx NSS subfield value in the Operating Mode field of the Operating Mode Notification frame or Operating Mode Notification element transmitted most recently by the VHT beamformee

If the Feedback Type indicates SU, the Nc Index field value in the VHT MIMO Control field is determined by the VHT beamformee.

The Nr Index field in the VHT MIMO Control field shall be set to the same value as the RXVECTOR parameter NUM_STS of the corresponding VHT NDP. The Nc Index field shall not be set to a value larger than the Nr Index value in the VHT MIMO Control field. A VHT beamformee shall set the value of the Channel Width subfield in the VHT MIMO Control field of a VHT Compressed Beamforming frame to the same value as the RXVECTOR parameter CH_BANDWIDTH of the corresponding VHT NDP frame.

A VHT beamformee shall not include MU Exclusive Beamforming Report information in VHT Compressed Beamforming feedback if the Feedback Type subfield in the MIMO Control field of the VHT Compressed Beamforming frame(s) indicates SU. A VHT beamformee shall include both VHT Compressed Beamforming Report information and MU Exclusive Beamforming Report information in VHT Compressed Beamforming feedback if the Feedback Type subfield in the MIMO Control field of the VHT Compressed Beamforming frame(s) indicates MU.

A VHT beamformee that transmits VHT Compressed Beamforming feedback shall include neither the VHT Compressed Beamforming Report information and nor the MU Exclusive Beamforming Report information if the transmission duration of the PPDU carrying the VHT Compressed Beamforming Report information and any MU Exclusive Beamforming Report information would exceed the maximum PPDU duration.

The value of the Sounding Dialog Token Number subfield in the VHT MIMO Control field shall be set to the same value as the Sounding Dialog Token Number subfield in the Sounding Dialog Token field in the corresponding VHT NDP Announcement frame.

NOTE 1—The VHT beamformer can use the sounding dialog token in the VHT Compressed Beamforming frame(s) of the VHT Compressed Beamforming feedback to associate the feedback with a prior VHT NDP Announcement frame and thus compute the delay between sounding and receiving the feedback. The VHT beamformer can use this delay time when making a decision regarding the applicability of the feedback for the link.

NOTE 2—Recovery in the case of a missing response to a VHT NDP Announcement or Beamforming Report Poll frame follows the rules for multiple frame transmission in an EDCA TXOP (see 9.19.2.4).

VHT Compressed Beamforming feedback is comprised of the VHT Compressed Beamforming Report information (see Table 8-53f) and the MU Exclusive Beamforming Report information (see Table 8-53i). Subclause 8.5.23.2 specifies how VHT Compressed Beamforming feedback is converted into a VHT Compressed Beamforming frame, and it also specifies the rules for the presence or absence of the two fields listed here.

9.31.5.3 Rules for fragmented feedback in VHT sounding protocol sequences

VHT Compressed Beamforming feedback shall be transmitted in a single VHT Compressed Beamforming frame unless the result would be a VHT Compressed Beamforming frame that exceeds the VHT beamformer's maximum MPDU length capability.

NOTE—The VHT beamformee might therefore have to transmit an MPDU that is bigger than the VHT beamformee is capable of receiving.

If VHT Compressed Beamforming feedback would result in a VHT Compressed Beamforming frame that exceeds the VHT beamformer's maximum MPDU length capability, the VHT Compressed Beamforming feedback shall be split into up to 8 feedback segments, with each feedback segment sent in a different VHT Compressed Beamforming frame and containing successive portions of the VHT Compressed Beamforming feedback consisting of the VHT Compressed Beamforming Report information followed by any MU Exclusive Beamforming Report information. Each of the feedback segments except the last shall contain the maximum number of octets allowed by the VHT beamformer's maximum MPDU length capability. The last feedback segment may be smaller. Each feedback segment is identified by the value of the Remaining Feedback Segments subfield and the First Feedback Segment subfield in the VHT MIMO Control field as defined in 8.4.1.47; the other nonreserved subfields of the VHT MIMO Control field shall be the same for all feedback segments. All feedback segments shall be sent in a single A-MPDU and shall be included in the A-MPDU in the descending order of the Remaining Feedback Segments subfield values.

NOTE—The feedback segments of a VHT Compressed Beamforming report are not MSDU/MMPDU fragments and can be included in an A-MPDU as described in this subclause.

A VHT beamformer, in its first attempt to retrieve VHT Compressed Beamforming feedback from a VHT beamformee that is not the one indicated by the first STA Info field, shall transmit a Beamforming Report Poll frame to poll all possible feedback segments of the VHT Compressed Beamforming feedback from the VHT beamformee, by setting all the bits in the Feedback Segment Retransmission Bitmap field of the Beamforming Report Poll frame to 1.

If a VHT beamformer fails to receive some or all feedback segments of VHT Compressed Beamforming feedback, the VHT beamformer may, subject to the condition on VHT SU-only beamformees described at the end of this subclause, request a selective retransmission of missing feedback segments by transmitting a Beamforming Report Poll frame with the Feedback Segment Retransmission Bitmap field set as described in 8.3.1.21 to indicate the feedback segments requested for retransmission. If the VHT beamformer fails to receive the feedback segment with the First Feedback Segment field set to 1, the VHT beamformer may request a selective retransmission of missing feedback segments assuming the VHT Compressed Beamforming feedback is split into 8 feedback segments. The VHT beamformer may also request the retransmission of all feedback segments by setting all the bits in the Feedback Segment Retransmission Bitmap field of the Beamforming Report Poll frame to 1.

A VHT beamformee that transmits VHT Compressed Beamforming feedback including the VHT Compressed Beamforming Report information and any MU Exclusive Beamforming Report information in response to a Beamforming Report Poll frame shall either transmit only the feedback segments indicated in the Feedback Segment Retransmission Bitmap field in the Beamforming Report Poll frame excluding the indicated feedback segments that do not exist at the VHT beamformee or transmit all the feedback segments that exist at the VHT beamformee disregarding the Feedback Segment Retransmission Bitmap field in the Beamforming Report Poll frame.

A VHT beamformer shall not transmit a Beamforming Report Poll frame to a VHT SU-only beamformee unless the VHT beamformer has received at least one feedback segment of the VHT Compressed Beamforming feedback from the VHT beamformee in the current frame exchange sequence.

9.31.6 Transmission of a VHT NDP

A VHT NDP shall use the SU PPDU format as described in 22.1.4. A STA shall transmit a VHT NDP using the following TXVECTOR parameters:

- APEP_LENGTH set to 0
- NUM_USERS set to 1
- NUM_STS indicates two or more space-time streams
- CH_BANDWIDTH set to the same value as the TXVECTOR parameter CH_BANDWIDTH in the preceding VHT NDP Announcement frame
- GROUP_ID and PARTIAL_AID are set as described in 9.17a

The number of space-time streams sounded and as indicated by the NUM_STS parameter shall not exceed the value indicated in the Beamformee STS Capability field in the VHT Capabilities element of any intended recipient of the VHT NDP. The NUM_STS parameter may be set to any value, subject to the constraint of the previous sentence, regardless of the value of the Supported VHT-MCS and NSS Set field of the VHT Capabilities element at either the transmitter or recipient of the NDP.

The destination of a VHT NDP is equal to the RA of the immediately preceding VHT NDP Announcement frame.

The source of a VHT NDP is equal to the TA of the immediately preceding VHT NDP Announcement frame.

10. MLME

10.1 Synchronization

10.1.3 Maintaining synchronization

10.1.3.2 Beacon generation in non-DMG infrastructure networks

Change the last paragraph of 10.1.3.2 as follows:

An AP whose last transmitted values for the Tx STBC subfield and Rx STBC subfield of the HT Capabilities Info field of the HT Capabilities element are both nonzero may transmit an STBC Beacon frame and group addressed traffic using the basic STBC MCS, as defined in 9.7.3. An AP that transmits an STBC Beacon shall set the Dual Beacon field to 1 in transmitted HT Operation elements. A VHT AP shall set the Dual Beacon field to 0 in transmitted HT Operation elements. The STBC Beacon field shall be set to 1 to identify an STBC Beacon frame. The TBTT for the STBC Beacon frame shall be offset by half of a beacon interval from the TBTT of the non-STBC Beacon frame. Except for the setting of the STBC Beacon field, TIM field, and TSF field, all other fields inside the STBC Beacon frame shall be identical to the non-STBC Beacon frame.

10.2 Power management

10.2.1 Power management in a non-DMG infrastructure network

10.2.1.17 TIM broadcast

Change the 11th paragraph of 10.2.1.17 as follows:

The AP shall increase the value (modulo 256) of the Check Beacon field in the next transmitted TIM frame(s) when a critical update occurs to any of the elements inside the Beacon frame. The following events shall classify as a critical update:

- a) Inclusion of a Channel Switch Announcement
- b) Inclusion of an Extended Channel Switch Announcement
- c) Modification of the EDCA parameters
- d) Inclusion of a Quiet element
- e) Modification of the DSSS Parameter Set
- f) Modification of the CF Parameter Set
- g) Modification of the FH Parameter Set
- h) Modification of the HT Operation element
- i) Inclusion of a Wide Bandwidth Channel Switch element
- j) Inclusion of a Channel Switch Wrapper element
- k) Inclusion of a Operating Mode Notification element
- l) Inclusion of a Quiet Channel element
- m) Modification of the VHT Operating element

Insert the following subclause, 10.2.1.19, after 10.2.1.18.3:

10.2.1.19 VHT TXOP power save

A VHT AP supports the operation of non-AP VHT STAs in TXOP power save mode in a BSS when the dot11VHTTXOPPowerSaveOptionImplemented at the AP is true. Non-AP VHT STAs that are in Active mode (see Table 10-1) and have dot11VHTTXOPPowerSaveOptionImplemented equal to true operate in TXOP power save mode. A STA that has dot11VHTTXOPPowerSaveOptionImplemented equal to true shall set the VHT TXOP Power Save field in the VHT Capabilities element to 1; otherwise, the STA shall set the field to 0. A VHT AP may allow non-AP VHT STAs in TXOP power save mode to enter the Doze state during a TXOP. A VHT AP shall indicate this by transmitting a VHT PPDU with the TXVECTOR parameter TXOP_PS_NOT_ALLOWED set to 0. The value of this parameter in the TXVECTOR of all VHT PDUs transmitted by the VHT AP may be changed from 1 to 0 during the TXOP to enable TXOP PS for the remainder of the TXOP. The value of this parameter in the TXVECTOR of all VHT PDUs transmitted by VHT AP shall not be changed from 0 to 1 during the TXOP. If the dot11VHTTXOPPowerSaveOptionImplemented at VHT AP is false then the VHT AP shall set the TXOP_PS_NOT_ALLOWED to 1 in the TXVECTOR of the frames with FORMAT VHT.

If the AP allows non-AP VHT STAs to enter Doze state during a TXOP, then a non-AP VHT STA that is in VHT TXOP power save mode may enter the Doze state till the end of that TXOP when one of the following conditions is met:

- On receipt of a VHT MU PPDU, the STA determines that it is not a member of the group indicated by the RXVECTOR parameter GROUP_ID.
- On receipt of an SU PPDU, the STA determines that the RXVECTOR parameter PARTIAL_AID is not equal to 0 nor does it match the STA's partial AID.
- The STA finds that the PARTIAL_AID in the RXVECTOR matches its partial AID but the RA in the MAC header of the corresponding frame that is received correctly does not match the MAC address of the STA.
- The STA receives a frame with an RXVECTOR parameter NUM_STS equal to 0 if it is a member of group indicated by RXVECTOR GROUP_ID.
- In a received VHT NDP Announcement frame, the STA finds that the RXVECTOR parameter PARTIAL_AID is 0 and the AID in the STA Info field is not its AID.
- The STA receives a frame intended for it with the More Data field equal to 0 and the Ack Policy subfield in the QoS Control field is equal to No Ack or sends an acknowledgment if Ack Policy subfield is not equal to No Ack.

The VHT AP shall include a NAV-set sequence (e.g., RTS/CTS) at the beginning of such a TXOP with the Duration/ID value set to the remainder of the TXOP duration. A VHT AP shall not transmit frames to a non-AP VHT STA that has been allowed to enter Doze state according to the conditions above for the remainder of the TXOP.

NOTE—A VHT AP does not transmit VHT SU PDUs in the current TXOP if the AP has already transmitted a VHT PPDU with the TXVECTOR parameter TXOP_PS_NOT_ALLOWED set to 0 in the same TXOP and does not want the STAs that are in Awake state to enter the Doze state.

If a VHT AP truncates the TXOP in which it allowed STAs to enter Doze state, then the VHT AP shall not transmit frames to the STAs that were allowed to enter the Doze state until the NAV set at the start of the TXOP has expired.

If the AP does not receive an acknowledgment after transmitting an individually addressed frame containing all or part of an MSDU, A-MSDU or MMPDU sent with the More Data field equal to 0 to a non-AP VHT STA that is in VHT TXOP power save mode and the AP had set the TXVECTOR parameter TXOP_PS_NOT_ALLOWED to 0, it shall retransmit that frame at least once within the same TXOP,

subject to applicable retry or lifetime limit, TXOP limit and the rules on TXOP sharing (see 9.19.2.3a). If an acknowledgment to the retransmission of this last frame in the same TXOP is not received, it may wait until the next TXOP to further retransmit that frame, subject to its applicable retry or lifetime limit.

NOTE—An AP that receives from a VHT STA in TXOP power save mode a BlockAck frame that is a response to an A-MPDU containing MPDUs with the More Data field equal to 0 cannot expect to receive a response to subsequent MPDUs retransmitted in the same TXOP because the VHT STA might be in the Doze state.

A VHT STA that is in TXOP power save mode and has entered Doze state shall continue to operate its NAV timer during Doze state and shall transition into Awake state on expiry of the NAV timer.

NOTE—The STA can contend for access to the medium immediately on the expiry of the NAV timer.

10.3 STA authentication and association

10.3.5 Association, reassociation, and disassociation

10.3.5.3 PCP/AP association receipt procedures

Insert a new list item h) into the lettered list of the second paragraph of 10.3.5.3, and re-letter the subsequent list items accordingly:

- h) The SME shall refuse an association request from a VHT STA that does not support all the <VHT-MCS, NSS> tuples indicated by the Basic VHT-MCS and NSS Set field of the VHT Operation parameter in the MLME-START.request primitive.

10.3.5.5 PCP/AP reassociation receipt procedures

Insert a new list item g) into the lettered list of the second paragraph of 10.3.5.5, and re-letter the subsequent list items accordingly:

- g) The SME shall refuse a reassociation request from a VHT STA that does not support all the <VHT-MCS, NSS> tuples indicated by the Basic VHT-MCS and NSS Set field of the VHT Operation parameter in the MLME-START.request primitive.

10.8 TPC procedures

10.8.2 Association based on transmit power capability

Insert the following paragraph and note at the end of 10.8.2:

If a STA sends a Country element, a Power Constraint element, and a VHT Transmit Power Envelope element, where the interpretation of the Maximum Transmit Power Level field in the Country element for a 20 MHz or 40 MHz Subband Triplet field is the same as the Local Maximum Transmit Power Unit Interpretation subfield, then at least one of local power constraints indicated by the Local Maximum Transmit Power For 20 MHz and Local Maximum Transmit Power For 40 MHz fields in the VHT Transmit Power Envelope element shall be the same as the indicated local power constraint expressed by the combination of Country element and Power Constraint element.

NOTE—An example of when the interpretation of the Maximum Transmit Power Level field in the Country element for a 20 MHz or 40 MHz Subband Triplet field is the same as the Local Maximum Transmit Power Unit Interpretation subfield is when both are EIRP.

Insert the following subclause, 10.8.3a, after 10.8.3:

10.8.3a Interpretation of transmit power capability

If the Beacon or Probe Response frame most recently received from an AP by a VHT STA that has dot11SpectrumManagementRequired or dot11RadioMeasurementActivated equal to true includes one or more VHT Transmit Power Envelope elements, then the units of the Minimum Transmit Power Capability and Maximum Transmit Power Capability fields within the Power Capability element sent in the STA's (Re)Association Request frame to the AP shall be interpreted according to the Local Maximum Transmit Power Unit Interpretation subfield in the Transmit Power Information field in the VHT Transmit Power Envelope element (see 8.4.2.164) sent first in the Beacon or Probe Response frame; otherwise, the units of the Minimum Transmit Power Capability and Maximum Transmit Power Capability fields within the Power Capability element sent in the STA's (Re)Association Request frame to the AP shall be interpreted as EIRP.

If the Beacon or Probe Response frame most recently received from a neighbor mesh STA by a VHT mesh STA that has dot11SpectrumManagementRequired or dot11RadioMeasurementActivated equal to true includes one or more VHT Transmit Power Envelope elements, then the units of the Minimum Transmit Power Capability and Maximum Transmit Power Capability fields within the Power Capability element sent in the Mesh Peering Open frame to the neighbor mesh STA shall be interpreted according to the Local Maximum Transmit Power Unit Interpretation subfield in the Transmit Power Information field in the VHT Transmit Power Envelope element (see 8.4.2.164) sent first in the Beacon or Probe Response frame. Otherwise, the units of the Minimum Transmit Power Capability and Maximum Transmit Power Capability fields within the Power Capability element sent in the VHT mesh STA's Mesh Peering Open frame to the neighbor mesh STA shall be interpreted as EIRP.

10.8.4 Specification of regulatory and local maximum transmit power levels

Change the second and third paragraphs of 10.8.4, and insert a new fourth paragraph as follows:

A STA shall determine a local maximum transmit power for the current channel by selecting the minimum of the following:

- Unless the STA is a VHT STA and has received a VHT Transmit Power Envelope element for a channel width of 20 MHz and 40 MHz, Any local maximum transmit power received in the combination of a Country element and a Power Constraint element from the AP in its BSS, PCP in its PBSS, another STA in its IBSS, or a neighbor peer mesh STA in its MBSS and
- Any local maximum transmit power received in a VHT Transmit Power Envelope element from the AP in its BSS, another STA in its IBSS, or a neighbor peer mesh STA in its MBSS
- Any local maximum transmit power for the channel regulatory domain known by the STA from other sources.

The Local Power Constraint field of any transmitted Power Constraint element and each Local Maximum Transmit Power For X MHz field (where X = 20, 40, 80, or 160/80+80) in the VHT Transmit Power Envelope element shall be set to a value that allows the mitigation requirements to be satisfied in the current channel.

A STA that transmits a VHT Transmit Power Envelope element shall set the Local Maximum Transmit Power Unit Interpretation subfield in the Transmit Power Information field to an allowed value as defined in Annex E.

Insert the following paragraphs after the now seventh paragraph (“An AP in a BSS, a STA in an IBSS, ...”) of 10.8.4:

A VHT AP in a BSS, a VHT STA in an IBSS, and a VHT mesh STA in a MBSS shall advertise the local maximum transmit power for that STA’s operating channel in Beacon frames and Probe Response frames using one VHT Transmit Power Envelope element for each distinct value of the Local Maximum Transmit Power Unit Interpretation subfield that is supported by the BSS, IBSS, or MBSS, respectively. Each VHT Transmit Power Envelope element shall include a local power constraint for all channel widths supported by the BSS.

VHT STAs that have dot11RadioMeasurementActivated equal to true should be able to reduce their EIRP to 0 dBm.

NOTE—When the local maximum transmit power is set by an AP for radio resource management, a typical low value for the local power constraint is 0 dBm. A STA that cannot reduce its transmit power to this level or below will not be able to associate to the AP.

Change the last paragraph of 10.8.4 as follows:

Where TPC is being used for radio measurement without spectrum management, the inclusion of a Power Constraint element and a VHT Transmit Power Envelope element in Beacon, DMG Beacon, Announce, and Probe Response frames shall be optional.

10.9 DFS procedures

10.9.3 Quieting channels for testing

Change 10.9.3 as follows:

A PCP/AP in a DMG BSS may measure one or more channels itself, or the PCP/AP may request associated non-PCP/non-AP STAs in the same BSS to measure one or more channels, either in a dedicated measurement interval or during normal operation. The PCP/AP in a DMG BSS may schedule a service period allocated to itself to quiet the associated STAs and use the self-allocated SP for measurement.

An AP in a BSS or a mesh STA in an MBSS may schedule quiet intervals by transmitting one or more Quiet elements and/or one or more Quiet Channel elements with the AP Quiet Mode field equal to 1 in Beacon frames and Probe Response frames.

A non-VHT AP shall not transmit a Quiet Channel element. An AP shall not transmit a Quiet Channel element with the AP Quiet Mode equal to 0 in frames that do not include at least one Quiet element. An AP shall not transmit more than one Quiet Channel element with the AP Quiet Mode equal to 0. An AP shall not transmit a Quiet Channel element if the BSS operating channel width is neither 160 MHz nor 80+80 MHz.

The AP or mesh STA may stop scheduling quiet intervals or change the value of the Quiet Period field, the Quiet Duration field, and the Quiet Offset field in Quiet elements as required or Quiet Channel elements with the AP Quiet Mode field equal to 1. Only the most recently received Beacon frame or Probe Response frame defines all future quiet intervals; therefore, quiet intervals based on older Beacon frames or Probe Response frames shall be discarded.

A STA in an IBSS may schedule quiet intervals only if it is the DFS owner. ~~It shall~~ In order to set a quiet interval schedule, ~~the STA transmits by transmitting~~ one or more Quiet elements or Quiet Channel elements with the AP Quiet Mode field equal to 1 in the first Beacon frame establishing the IBSS. All STAs in an IBSS shall continue these quiet interval schedules by including appropriate Quiet elements or Quiet Channel elements with the AP Quiet Mode field equal to 1 in any transmitted Beacon frames or Probe Response frames.

Multiple independent quiet intervals may be scheduled, so that not all quiet intervals have the same timing relationship to TBTT, by including multiple Quiet elements or Quiet Channel elements with the AP Quiet Mode field equal to 1 in Beacon frames or Probe Response frames.

Control of the channel is lost at the start of a quiet interval, and the following quieting rules apply:

- The NAV is set by all the non-VHT STAs in the BSS for the length of the quiet interval established by a Quiet element.
- The NAV set by all the VHT STAs in the BSS for the duration of the quiet interval established by a Quiet element if a Quiet Channel element was not sent or received with the Quiet element.
- A VHT STA in the BSS shall not transmit PPDU's that occupy the secondary 80 MHz channel or transmit PPDU's to the AP during the quiet interval established by a Quiet element if a Quiet Channel element with the AP Quiet Mode equal to 0 was sent or received with the Quiet element.
- A VHT STA shall not transmit PPDU's that occupy the secondary 80 MHz channel during the quiet interval established by a Quiet Channel element with the AP Quiet Mode field in the Quiet Channel element equal to 1.
- Transmission by any non-VHT STA in the BSS of any MPDU and any associated acknowledgment of the BSS within either the primary channel or the secondary channel (if present) of the BSS shall ~~be~~ complete before the start of the quiet interval.
- Transmission by any VHT STA in the BSS of any MPDU and any associated acknowledgment of the BSS shall complete before the start of the quiet interval established by a Quiet element if a Quiet Channel element was not sent or received with the Quiet element.
- Transmission by any VHT STA in the BSS of any PPDU's that occupy the secondary 80 MHz channel or are directed to the AP, and any associated acknowledgment of the BSS, shall complete before the start of the quiet interval established by a Quiet element if a Quiet Channel element with the AP Quiet Mode equal to 0 was sent or received with the Quiet element.
- Transmission by any VHT STA in the BSS of any PPDU's that occupy the secondary 80 MHz channel and any associated acknowledgment of the BSS shall complete before the start of the quiet interval established by a Quiet Channel element with the AP Quiet Mode field in the Quiet Channel element equal to 1.

If, before starting transmission of an MPDU, there is not enough time remaining ~~to allow the transmission for an exchange to complete so that the first transmission in the exchange would be disallowed by the quieting rules before the quiet interval starts,~~ then the STA shall defer the transmission by selecting a random backoff time, using the present CW (without advancing to the next value in the series). The short retry counter and long retry counter for the MSDU or A-MSDU are not affected.

10.11 Radio measurement procedures

10.11.9 Specific measurement usage

10.11.9.1 Beacon Report

Change the ninth paragraph of 10.11.9.1 as follows:

On accepting an active or passive mode Beacon measurement request, a STA shall conduct measurements as follows:

- If the Channel Number is 0 and the Operating Class identifies the location of the primary channel, then a STA shall conduct iterative measurements on all supported channels in the specified Operating Class where measurement is permitted on the channel and the channel is valid for the current regulatory domain.

- If the Channel Number is 0 and if the Operating Class encompasses a primary channel but does not identify the location of the primary channel, then a STA shall conduct iterative measurements on all primary channel positions within all requested and supported channels where the measurement is permitted on the channel and the channel is valid for the current regulatory domain.
- If the Channel Number is 255, the Operating Class identifies the location of the primary channel, and the Beacon Request includes AP Channel Report subelements, then a STA shall conduct iterative measurements on all supported channels listed in the AP Channel Report subelements that are valid for the current regulatory domain. If there is no AP Channel Report subelement included in the Beacon Report request, a STA shall conduct iterative measurements on all supported channels listed in the latest AP Channel Report received from the serving AP that are valid for the current regulatory domain. If there are no AP Channel Report subelements included in the Beacon Request, and no AP Channel Report included in last received AP Beacon frame, the STA shall reject the Beacon Report request.
- If the Channel Number is 255, the Operating Class encompasses a primary channel but does not identify the location of the primary channel, and the Beacon Request includes AP Channel Report subelements, then a STA shall conduct iterative measurements on all primary channel positions within all requested (in the AP Channel Report) and supported channels that are valid for the current regulatory domain. If there are no AP Channel Report subelements included in the Beacon Request, the STA shall reject the Beacon Report request.
- If the Channel Number is a value other than 0 or 255, then a STA shall conduct iterative measurements on the requested channel that Channel Number, where the measurement is permitted on the channel and the channel is valid for the current regulatory domain.

Insert the following paragraphs at the end of 10.11.9.1:

A non-VHT STA shall not include a Wide Bandwidth Channel Switch subelement in the Beacon Request. A VHT STA shall not include a Wide Bandwidth Channel Switch subelement in the Beacon Request or Beacon Report sent to a non-VHT STA. If the Wide Bandwidth Channel Switch subelement is included in a Beacon Request, then the Operating Class shall indicate a 40 MHz channel spacing.

If N (where $N \geq 1$) AP Channel Report subelements containing an Operating Class with an 80+ Behavior Limit (as defined in Annex E) are included contiguously in a Beacon Request, then the N subelements shall be followed by one AP Channel Report subelement containing an Operating Class without an 80+ Behavior Limit (as defined in Annex E). All $N+1$ Channel List fields in each of these subelements shall contain the same number L of channel numbers. This sequence of $N+1$ AP Channel Report subelements indicates a list of L noncontiguous channels comprising $N+1$ frequency segments, where the l th channel number in the n th Channel List field identifies the channel center frequency of the n th frequency segment.

10.11.9.3 Channel Load Report

Change 10.11.9.3 as follows:

If `dot11RMChannelLoadMeasurementActivated` is true and a station accepts a Channel Load Request, it shall respond with a Radio Measurement Report frame containing one Measurement (Channel Load) Report element. The Channel Load field is defined as the percentage of time, linearly scaled with 255 representing 100%, that the STA sensed the medium was busy, as indicated by either the physical or virtual carrier sense mechanism or the physical carrier sense mechanism over the requested channel width (together referred to as the CS mechanism) mechanism. This percentage is computed using the following formula:

$$\text{Channel Load} = \text{Integer}((\text{channel busy time}/(\text{MeasurementDuration} \times 1024)) \times 255)$$

where channel busy time is defined to be the number of microseconds during which the CS mechanism, as defined in 9.3.2.1, has indicated a channel busy indication for the requested channel width.

If dot11RMChannelLoadMeasurementActivated is false, a station shall reject the received Channel Load Request and shall respond with a Channel Load Report with the Incapable bit in the Measurement Report Mode field set to 1.

If dot11RMChannelLoadMeasurementActivated is true and if a Channel Load Reporting Information subelement is included in a Channel Load Request, the STA shall respond with a Channel Load Report if the indicated Channel Load Reporting Condition is true. Otherwise, the STA shall not respond with a Channel Load Report.

A non-VHT STA shall not include a Wide Bandwidth Channel Switch subelement in the Channel Load Request. A VHT STA shall not include a Wide Bandwidth Channel Switch subelement in the Channel Load Request sent to a non-VHT STA. If the Wide Bandwidth Channel Switch subelement is included in a Channel Load Request or a Channel Load Report, then the Operating Class shall indicate a 40 MHz channel spacing.

10.11.9.4 Noise Histogram Report

Change the second paragraph of 10.11.9.4 as follows:

To compute the IPI densities, the STA shall measure the IPI in the specified channel at the specified channel width as a function of time over the measurement duration when NAV is equal to 0 (when virtual CS mechanism indicates idle channel) except during frame transmission or reception. The time resolution of the IPI measurements shall be in microseconds. The IPI densities are then computed for each of the nine possible IPI values using:

Insert the following paragraph at the end of 10.11.9.4:

A non-VHT STA shall not include a Wide Bandwidth Channel Switch subelement in the Noise Histogram Request. A VHT STA shall not include a Wide Bandwidth Channel Switch subelement in the Noise Histogram Request sent to a non-VHT STA. If the Wide Bandwidth Channel Switch subelement is included in a Noise Histogram Request or a Noise Histogram Report, then the Operating Class shall indicate a 40 MHz channel spacing.

10.11.18 AP Channel Report

Change the first paragraph of 10.11.18 as follows:

The AP Channel Report element contains a list of channels in an operating class where a STA is likely to ~~find~~ receive the Beacon or Probe Response frames sent by an AP, excluding the AP transmitting the AP Channel Report. An AP Channel Report element only includes channels that are valid for the regulatory domain in which the AP transmitting the element is operating and consistent with the Country element in the frame in which it appears. One AP Channel Report element is included in the Beacon frame for each regulatory domain, which includes channels on which a STA is likely to ~~find~~ receive the Beacon or Probe Response frames sent by an AP.

10.15 20/40 MHz BSS operation

10.15.2 Basic 20/40 MHz BSS functionality

Change the last paragraph of 10.15.2 as follows:

An HT STA that is a member of an IBSS adopts the value of the Secondary Channel Offset field in received frames according to the rules in 10.1.5 and shall not transmit either of the following:

- ~~A~~ value for the Secondary Channel Offset field that differs from the most recently adopted value-
- An operating class in the Extended Channel Switch Announcement frame or element with a different behavior than the currently adopted PrimaryChannelLowerBehavior or PrimaryChannelUpperBehavior

10.15.8 Support for DSSS/CCK in 40 MHz

Change 10.15.8 as follows:

Transmission and reception of PPDU's using DSSS/CCK by FC HT STAs is managed using the DSSS/CCK Mode in 40 MHz subfield of the HT Capabilities Info field in the HT Capabilities element (see 8.4.2.58.2).

An HT STA declares its capability to use DSSS/CCK rates while it has a 40 MHz operating channel width through the DSSS/CCK Mode in 40 MHz subfield of its (Re)Association Request frames.

If the DSSS/CCK Mode in 40 MHz subfield is equal to 1 in Beacon and Probe Response frames, an associated HT STA in a 20/40 MHz BSS may generate DSSS/CCK transmissions. If the subfield is equal to 0, then the following apply:

- Associated HT STAs shall not generate DSSS/CCK transmissions.
- The AP shall not include an ERP element in its Beacon and Probe Response frames.
- The AP shall not include DSSS/CCK rates in the Supported Rates element.
- The AP shall refuse association requests from a STA that includes only DSSS/CCK rates in its Supported Rates and Extended Supported Rates elements.

A STA not operating in the 2.4 GHz band shall set the DSSS/CCK Mode in 40 MHz subfield to 0.

10.15.9 STA CCA sensing in a 20/40 MHz BSS

Insert the following paragraph at the beginning of 10.15.9:

This subclause defines CCA sensing rules for an HT STA that is not a VHT STA. For rules related to a VHT STA, see 9.3.2.5a, 9.19.2.4, and 9.19.2.8.

10.15.12 Switching between 40 MHz and 20 MHz

Insert the following paragraph at the end of 10.15.12:

A VHT STA is not required to perform any of the behavior described in this subclause associated with Information Request and 20 MHz BSS Width Request.

10.16 Phased coexistence operation (PCO)

10.16.1 General description of PCO

Insert the following paragraph at the end of 10.16.1:

A VHT STA shall not transmit VHT PPDU's during a PCO 40 MHz phase.

10.17 20/40 BSS Coexistence Management frame usage

Change the last paragraph of 10.17 as follows:

A non-VHT STA that receives a 20/40 BSS Coexistence element with the Information Request field equal to 1, a value for the Address 1 field that matches the receiving STA using an individual address, and a nonwildcard BSSID field that matches the STA's BSS shall immediately queue for transmission a 20/40 BSS Coexistence Management frame with the transmitting STA as the recipient.

10.22 Tunneled direct link setup

10.22.1 General

Change the seventh paragraph of 10.22.1, and insert the subsequent paragraphs as follows:

Features that are not supported by the BSS but that are supported by both TDLS peer STAs may be used on a TDLS direct link between those STAs, except PCO. An example is the use of an HT MCS on a TDLS direct link between HT STAs when these STAs are associated with a non-HT BSS. Features that are supported by the BSS shall follow the BSS rules when they are used on a TDLS direct link on the base channel. The channel width of the TDLS direct link on the base channel shall not exceed the channel width of the BSS to which the TDLS peer STAs are associated, except when the TDLS Wider Bandwidth subfield in the Extended Capabilities element of the TDLS Setup Request frame or the TDLS Setup Response frame is 1 for both TDLS peer STAs. A TDLS direct link on the base channel shall not have a wider bandwidth than the BSS bandwidth if either of the STAs indicate that they are incapable of supporting wider bandwidth operation on the base channel.

A VHT STA with a TDLS link that is not an off-channel direct link shall use as its primary channel the channel indicated by the Primary Channel field in the HT Operation element. The channel width of a VHT TDLS link shall not be wider than the maximum channel width supported by either the TDLS initiator STA or the TDLS responder STA.

A 160 MHz bandwidth is defined to be identical to an 80+80 MHz bandwidth (i.e., one bandwidth is not wider than the other).

A STA shall not participate in a TDLS direct link with the same primary 80 MHz channel as the infrastructure BSS or another TDLS direct link of the STA but with a different secondary 80 MHz channel.

Insert the following paragraph at the end of 10.22.1:

The VHT Operation element shall be present in a TDLS Setup Confirm frame when both STAs are VHT capable and the TDLS direct link is not established in 2.4 GHz band. When TDLS Setup Confirm frame includes a VHT Operation element, the Basic VHT-MCS and NSS Set is reserved.

10.22.6 TDLS channel switching

10.22.6.3 TDLS channel switching and power saving

Insert the following subclauses, 10.22.6.4 to 10.22.6.4.5, after 10.22.6.3:

10.22.6.4 Setting up a wide bandwidth off-channel direct link

10.22.6.4.1 General

A wideband TDLS off-channel TDLS direct link is a 40 MHz, 80 MHz, 160 MHz, or 80+80 MHz off-channel TDLS direct link.

A wideband off-channel TDLS direct link may be started if both TDLS peer STAs indicated wideband support in the Supported Channel Width Set subfield of the VHT Capabilities element VHT Capabilities Info field included in the TDLS Setup Request frame or the TDLS Setup Response frame.

Switching to a wideband off-channel direct link is achieved by including any of the following information in the TDLS Channel Switch Request frame:

- An Operating Class element indicating 40 MHz Channel Spacing
- A Secondary Channel Offset element indicating SCA or SCB
- A Wide Bandwidth Channel Switch element indicating 80 MHz, 160 MHz, or 80+80 MHz channel width

The operating class in TDLS Channel Switch Request frame shall have a value representing 5 GHz for the channel starting frequency.

A TDLS peer VHT STA that announces new TPC parameters that come into effect at the same time as the switch to an off-channel direct link, shall include at least one VHT Transmit Power Envelope element in the transmitted TDLS Channel Switch Request frame. The recipient TDLS peer VHT STA that has dot11SpectrumManagementRequired or dot11RadioMeasurementActivated equal to true shall use the parameters in these received element(s) in the recipient STA's TPC calculations for the off-channel direct link.

When announcing new operating classes or both a new operating class table index and new operating classes that come into effect at the same time as the switch to the direct link and that express new regulatory requirements, the TDLS peer VHT STA initiating the switch shall include a Country element in a transmitted TDLS Channel Switch Request frame. The Country element shall contain all the Operating Classes for the off-channel direct link in Operating Triplet fields and zero Subband Triplet fields. The Country element shall include one Operating Triplet field that contains the same Operating Class as the Operating Class field in the same frame. The country indicated by the Country string in the TDLS Channel Switch Request frame shall be equal to the country indicated by the Country string of the BSS. The recipient TDLS peer VHT STA that has dot11MultiDomainCapabilityActivated, dot11SpectrumManagementRequired, or dot11RadioMeasurementActivated equal to true shall use the parameters in the received Country element in the TDLS Channel Switch Request frame in order to maintain regulatory compliance.

The TDLS peer STA initiating the switch to the wideband off-channel shall be the DO STA on that channel.

10.22.6.4.2 Basic wideband functionality

TDLS peer STAs may transmit up to 40 MHz, 80 MHz, 160 MHz, or 80+80 MHz PPDU on a 40 MHz, 80 MHz, 160 MHz, or 80+80 MHz direct link, respectively. A TDLS peer STA shall not transmit a 20 MHz PPDU in the non-primary channel of its 80 MHz, 160 MHz, or 80+80 MHz direct link.

A TDLS peer STA shall not transmit a 40 MHz PPDU that does not use the primary 40 MHz channel of its 80 MHz, 160 MHz, or 80+80 MHz direct link. A TDLS peer STA shall not transmit an 80 MHz PPDU that does not use the primary 80 MHz channel of its 160 MHz or 80+80 MHz direct link.

10.22.6.4.3 Channel selection for a wideband off-channel direct link

If a TDLS peer STA chooses to start a wideband direct link, the TDLS peer STA shall follow the primary channel selection rules defined in 10.39.2 and 10.23.14 and the secondary 80 MHz channel rule defined in 10.22.1.

10.22.6.4.4 Switching from a wideband to a 20 MHz direct link

Switching from a wideband off-channel direct link to a 20 MHz off-channel direct link is established through a TDLS channel switch. A STA operating on a wideband off-channel direct link shall accept a requested switch to a 20 MHz direct link.

10.22.6.4.5 CCA sensing and NAV assertion in a 20 MHz, 40 MHz, 80 MHz, 160 MHz, or 80+80 MHz direct link

TDLS peer VHT STAs shall follow the CCA rules defined in 9.3.2.5a, 9.19.2.4, and 9.19.2.8 and the NAV rules defined in 10.39.5.

10.25 Quality-of-Service management frame (QMF)**10.25.1 General****10.25.1.2 Default QMF policy**

Insert the following row into Table 10-12 in numeric order by category value:

Table 10-12—Default QMF policy

Description	Management Frame Subtype value from Table 8-1	Category value from Table 8-38	Action class	QMF access category
VHT	1101, 1110	21	0-2	AC_VO

Insert the following subclauses, 10.39 to 10.41 (including Table 10-19), after 10.38:

10.39 VHT BSS operation

10.39.1 Basic VHT BSS functionality

A VHT STA has dot11VHTOptionImplemented equal to true.

A STA that is starting a VHT BSS shall be able to receive and transmit at each of the <VHT-MCS, NSS> tuple values indicated by the Basic VHT-MCS and NSS Set field of the VHT Operation parameter of the MLME-START.request primitive and shall be able to receive at each of the <VHT-MCS, NSS> tuple values indicated by the Supported VHT-MCS and NSS Set field of the VHT Capabilities parameter of the MLME-START.request primitive.

A STA for which dot11VHTOptionImplemented is true shall set dot11HighThroughputOptionImplemented to true.

A STA that is a VHT AP or a VHT mesh STA declares its channel width capability in the Supported Channel Width Set subfield of the VHT Capabilities element VHT Capabilities Info field as described in Table 8-183v.

A VHT STA shall set the Supported Channel Width Set subfield in its HT Capabilities element HT Capabilities Info field to 1, indicating that both 20 MHz operation and 40 MHz operation are supported.

At a minimum, a VHT STA sets the Rx MCS Bitmask of the Supported MCS Set field of its HT Capabilities element according to the setting of the Rx VHT-MCS Map subfield of the Supported VHT-MCS and NSS Set field of its VHT Capabilities element as follows: for each subfield Max VHT-MCS For n SS, $1 \leq n \leq 4$, of the Rx VHT-MCS Map field with a value other than 3 (no support for that number of spatial streams), the STA shall indicate support for MCSs $8(n-1)$ to $8(n-1)+7$ in the Rx MCS Bitmask, where n is the number of spatial streams, except for those MCSs marked as unsupported as described in 9.7.11.3.

A STA that is a VHT AP or a VHT mesh STA shall set the STA Channel Width subfield in the HT Operation element HT Operation Information field and the Channel Width subfield in the VHT Operation element VHT Operation Information field to indicate the BSS operating channel width as defined in Table 10-19.

Table 10-19—VHT BSS operating channel width

HT Operation element STA Channel Width field	VHT Operation element Channel Width field	BSS operating channel width
0	0	20 MHz
1	0	40 MHz
1	1	80 MHz
1	2	160 MHz
1	3	80+80 MHz

A VHT STA shall determine the channelization using the combination of the information in the HT Operation element Primary Channel field and the VHT Operation element VHT Operation Information field Channel Center Frequency Segment 0 and Channel Center Frequency Segment 1 subfields (see 22.3.14).

A VHT AP or a VHT mesh STA shall set the HT Operation element HT Operation Information field Secondary Channel Offset subfield to indicate the secondary 20 MHz channel as defined in Table 8-130, if the BSS operating channel width is more than 20 MHz.

A VHT STA that is a member of a VHT BSS shall not transmit a 20 MHz VHT PPDU on a channel other than the primary 20 MHz channel of the BSS, except for a 20 MHz VHT PPDU transmission on an off-channel TDLS direct link as constrained by 10.22.6.4.2.

A VHT STA that is a member of a VHT BSS with a 40 MHz, 80 MHz, 160 MHz, or 80+80 MHz operating channel width shall not transmit a 40 MHz VHT PPDU that does not use the primary 40 MHz channel of the BSS, except for a 40 MHz VHT PPDU transmission on an off-channel TDLS direct link.

A VHT STA that is a member of a VHT BSS with an 80 MHz, 160 MHz, or 80+80 MHz operating channel width shall not transmit an 80 MHz VHT PPDU that does not use the primary 80 MHz channel of the BSS, except for an 80 MHz VHT PPDU transmission on an off-channel TDLS direct link.

A VHT STA that is a member of a VHT BSS with a 160 MHz or 80+80 MHz operating channel width shall not transmit a 160 MHz or 80+80 MHz VHT PPDU that does not use the primary 80 MHz channel and the secondary 80 MHz channel of the BSS, except for a 160 MHz or 80+80 MHz VHT PPDU transmission on an off-channel TDLS direct link.

A VHT STA shall not transmit to a second VHT STA using a bandwidth that is not indicated as supported in the Supported Channel Width Set subfield in the HT Capabilities element or VHT Capabilities element received from that VHT STA.

A VHT AP shall set the RIFS Mode field in the HT Operation element to 0.

10.39.2 Channel selection methods for a VHT BSS

Before a STA starts a VHT BSS, the STA shall perform a minimum of dot11VHTOBSSScanCount OBSS scan operations to search for existing BSSs (see 10.39.3).

If an AP or a mesh STA starts a VHT BSS that occupies some or all channels of any existing BSSs, the AP or mesh STA may select a primary channel of the new VHT BSS that is identical to the primary channel of any one of the existing BSSs.

If an AP or a mesh STA selects a primary channel for a new VHT BSS with a 40 MHz, 80 MHz, 160 MHz, or 80+80 MHz operating channel width from among the channels on which no beacons are detected during the OBSS scans, then the selected primary channel meets the following conditions:

- It shall not be identical to the secondary 20 MHz channel of any existing BSSs with a 40 MHz, 80 MHz, 160 MHz, or 80+80 MHz operating channel width.
- It should not overlap with the secondary 40 MHz channel of any existing BSSs with a 160 MHz or 80+80 MHz operating channel width.

A STA that is an AP or mesh STA should not start a VHT BSS with a 20 MHz operating channel width on a channel that is the secondary 20 MHz channel of any existing BSSs with a 40 MHz, 80 MHz, 160 MHz, or 80+80 MHz operating channel width, or is overlapped with the secondary 40 MHz channel of any existing BSSs with a 160 MHz or 80+80 MHz operating channel width.

NOTE—An AP or a mesh STA operating a VHT BSS with a 40 MHz, 80 MHz, 160 MHz, or 80+80 MHz operating channel width, on detecting an OBSS whose primary channel is the AP's or the mesh STA's secondary 20 MHz channel, might switch to 20 MHz BSS operation and/or move to a different channel.

10.39.3 Scanning requirements for VHT STA

An OBSS scan operation is a passive or active scan of a set of channels that are potentially affected by VHT BSS operation (see 10.1.4.1). Each channel in the set may be scanned more than once during a single OBSS scan operation. OBSS scans are performed by STAs that start a VHT BSS.

During an individual scan within an OBSS scan operation, the minimum per-channel scan duration is `dot11OBSSScanPassiveDwell` TUs (for a passive scan) or `dot11OBSSScanActiveDwell` TUs (for an active scan). During an OBSS scan operation, each channel in the set is scanned at least once per `dot11BSSWidthTriggerScanInterval` seconds, and the minimum total scan time (i.e., the sum of the scan durations) per channel within a single OBSS scan operation is `dot11OBSSScanPassiveTotalPerChannel` TUs (for a passive scan) or `dot11OBSSScanActiveTotalPerChannel` TUs (for an active scan).

NOTE—The values provided in the previous paragraph are minimum requirements. For some combinations of parameter values the minimum might be exceeded for some parameters in order to meet the minimum value constraints of other parameters.

10.39.4 Channel switching methods for a VHT BSS

A VHT AP announces a switch of operating channel by either of the following:

- Using the Channel Switch Announcement element, Channel Switch Announcement frame, or both, following the procedure described in 10.9.8.2
- Using the Extended Channel Switch Announcement element, Extended Channel Switch Announcement frame, or both, following the procedure described in 10.10

A VHT mesh STA announces a switch attempt of operating channel by either of the following:

- Using the Channel Switch Announcement element, Channel Switch Announcement frame, or both, following the procedure described in 10.9.8.4
- Using the Extended Channel Switch Announcement element, Extended Channel Switch Announcement frame, or both, following the procedure described in 10.10

A VHT AP or a VHT mesh STA may also announce a switch of operating channel width, a new Country String field (possibly including a new Operating Class table number), new operating classes, or new TPC parameters for the BSS that come into effect at the same time as the switch of operating channel.

NOTE—Other means to switch the operating channel width are described in 10.41.

The New Channel Number field in the Channel Switch Announcement element, Extended Channel Switch Announcement element, Channel Switch Announcement frame, or Extended Channel Switch Announcement frame identifies the primary 20 MHz channel after the switch. The value of the New Channel Number field is set to the value that `dot11CurrentPrimaryChannel` (see 22.3.14) will have after the switch.

If a Channel Switch Announcement frame is used to announce a switch to a 20 MHz operating channel width, then neither a Wide Bandwidth Channel Switch element nor a Secondary Channel Offset element shall be present in the frame, except that a Secondary Channel Offset element may be present in a Channel Switch Announcement frame if the Secondary Channel Offset field within the Secondary Channel Offset element is set to SCN.

If a Channel Switch Announcement element in a Beacon frame or Probe Response frame is used to announce a switch to a 20 MHz operating channel width, then a Wide Bandwidth Channel Switch subelement in a Channel Switch Wrapper element shall not be present in the same frame.

If an Extended Channel Switch Announcement element in a frame or an Extended Channel Switch Announcement frame is used to announce a switch to a 20 MHz operating channel width, then neither a Wide Bandwidth Channel Switch element nor a Wide Bandwidth Channel Switch subelement shall be present in the same frame.

NOTE—A Secondary Channel Offset element is never present with the Extended Channel Switch Announcement element in a frame or in the Extended Channel Switch Announcement frame. Instead, the indicated operating class within the Extended Channel Switch Announcement element or frame is used to differentiate between a BSS operating channel width of 20 MHz and a BSS operating channel width greater than 20 MHz as well as indicate the location of the secondary 20 MHz channel. When switching to a 20 MHz operating channel width, the operating class indicated within the Extended Channel Switch Announcement element or frame has a channel spacing of 20 MHz. When switching to an operating channel width greater than 20 MHz, the operating class indicated within the Extended Channel Switch Announcement element or frame has a channel spacing of 40 MHz.

If a Channel Switch Announcement frame is used to announce a switch to a 40 MHz operating channel width, then the following apply:

- The Secondary Channel Offset element shall be present in the frame.
- The Wide Bandwidth Channel Switch shall not be present in the frame.

If a Channel Switch Announcement element is used in a Beacon or Probe Response frame to announce a switch to a 40 MHz operating channel width, then the Wide Bandwidth Channel Switch subelement in the Channel Switch Wrapper element shall also be present in the same frame.

If an Extended Channel Switch Announcement element is used in a Beacon or Probe Response frame to announce a switch to a 40 MHz operating channel width, then the Wide Bandwidth Channel Switch subelement in the Channel Switch Wrapper element may be present in the same frame.

NOTE—The indicated operating class within the Extended Channel Switch Announcement element identifies the bandwidth and the relative position of the primary 20 MHz and secondary 20 MHz channels. Hence a Wide Bandwidth Channel Switch subelement is unnecessary when the Extended Channel Switch Announcement element is used for a channel switch to a 40 MHz bandwidth.

If a Channel Switch Announcement frame is used to announce a switch to an 80 MHz, 80+80 MHz, or 160 MHz operating channel width, then both the Secondary Channel Offset element and the Wide Bandwidth Channel Switch element shall be present in the frame.

If a Channel Switch Announcement element or an Extended Channel Switch Announcement element is used in a frame to announce a switch to an 80 MHz, 80+80 MHz, or 160 MHz operating channel width, then a Wide Bandwidth Channel Switch subelement in the Channel Switch Wrapper element shall be present in the same frame.

If an Extended Channel Switch Announcement frame is used to announce a switch to an 80 MHz, 80+80 MHz, or 160 MHz operating channel width, then the Wide Bandwidth Channel Switch element shall be present in the frame.

If an Extended Channel Switch Announcement element or Extended Channel Switch Announcement frame is used to announce a switch to an 80 MHz, 80+80 MHz, or 160 MHz BSS operating channel width, then

- The value of the New Operating Class field identifies the primary 40 MHz channel, and
- The Operating Triplet fields within the New Country subelement or element, respectively, shall indicate all the operating classes for the switched BSS.

If new BSS TPC parameters are announced that come into effect at the same time as the channel switch, then a STA that is a VHT AP, a VHT STA in an IBSS, or a VHT mesh STA in an MBSS shall include

- At least one New VHT Transmit Power Envelope element in a transmitted Channel Switch Announcement frame or Extended Channel Switch Announcement frame and
- At least one New VHT Transmit Power Envelope subelement in a transmitted Channel Wrapper element in Beacon and Probe Response frames.

A recipient VHT STA in the BSS STA that has dot11SpectrumManagementRequired or dot11RadioMeasurementActivated equal to true and that maintains association with the BSS after the switch shall use the parameters in these received elements and subelements in the recipient STA's TPC calculations for the new operating channel and operating channel width (see 10.8). If both New VHT Transmit Power Envelope elements and New VHT Transmit Power Envelope subelements are transmitted for the switch, the set of New VHT Transmit Power Envelope elements and set of subelements shall contain the same set of values for the Local Maximum Transmit Power Unit Interpretation subfield, and New VHT Transmit Power Envelope elements and subelements that have the same value for the Local Maximum Transmit Power Unit Interpretation subfield shall also have the same values for their other fields.

If a new country string, new operating classes or both, are coming into effect at the same time as the channel switch, then a STA that is a VHT AP, a VHT STA in an IBSS, or a VHT mesh STA in an MBSS shall include

- A New Country element in a transmitted Extended Channel Switch Announcement frame and
- A New Country subelement in a transmitted Channel Wrapper element.

The New Country element or subelement shall contain all the Operating Classes for the BSS after the switch. The New Country element or subelement, transmitted in an Extended Channel Switch Announcement frame or in the same frame as an Extended Channel Switch Announcement element, respectively, shall include one Operating Triplet field that contains the same Operating Class as the New Operating Class field in the Extended Channel Switch Announcement frame or Extended Channel Switch Announcement element. A recipient VHT STA in the BSS STA that has dot11MultiDomainCapabilityActivated, dot11SpectrumManagementRequired, or dot11RadioMeasurementActivated equal to true and that maintains association with the BSS after the switch shall use the parameters in these received elements and subelements in order to maintain regulatory compliance. If both New Country elements and New Country subelements are transmitted for the switch, their fields shall be the same.

A Channel Switch Wrapper element shall not be included in Beacons and Probe Responses if the element contains zero subelements.

NOTE—Channel Switch Wrapper is not defined to carry subelements in the case of a switch to 20 MHz and when no change to the country string, operating classes or TPC parameters are announced.

A VHT STA uses the VHT Transmit Power Envelope element only for TPC of 80 MHz, 160 MHz, and 80+80 MHz transmissions. In the Country element, a VHT STA shall include zero Subband Triplet fields in a Operating/Subband Sequence field that contains an Operating Class field for which the "Channel Spacing (MHz)" column in the applicable table in Annex E equals 80 or 160.

An AP that switches the BSS to a lower operating channel width may recalculate the TS bandwidth budget and may delete one or more active TSs by invoking the MLME-DELTS.request primitive with a ReasonCode value of SERVICE_CHANGE_PRECLUDES_TS.

A VHT STA that is a member of an IBSS shall not transmit values in the Wide Bandwidth Channel Switch element that change the frequency ordering of the primary 40 MHz channel and the secondary 40 MHz channel from the ordering of the most recently adopted operating channel, if the operating channel includes

a secondary 40 MHz channel. A VHT STA that is a member of an IBSS shall not transmit values in the Wide Bandwidth Channel Switch element that change the frequency ordering of the primary 80 MHz channel and the secondary 80 MHz channel from the ordering of the most recently adopted operating channel, if the operating channel includes a secondary 80 MHz channel.

10.39.5 NAV assertion in a VHT BSS

A VHT STA shall update its NAV as described in 9.3.2.4 using the Duration/ID field value in any frame that does not have an RA matching the STA's MAC address and that was received in a 20 MHz PPDU in the primary 20 MHz channel or received in a 40 MHz PPDU in the primary 40 MHz channel or received in an 80 MHz PPDU in the primary 80 MHz channel or received in a 160 MHz or 80+80 MHz PPDU.

NOTE—The PHY layer might filter out a PPDU as described in 22.3.21 or not receive a PPDU due to TXOP power saving described in 10.2.1.19. If so, frames in the PPDU are not received by the MAC and have no effect on the NAV.

10.39.6 VHT STA antenna indication

A VHT STA that does not change its Rx antenna pattern after association shall set the Rx Antenna Pattern Consistency subfield in the VHT Capabilities Info field to 1; otherwise, the STA shall set the Rx Antenna Pattern Consistency subfield in the VHT Capabilities Info field to 0.

A VHT STA that does not change its Tx antenna pattern after association shall set the Tx Antenna Pattern Consistency subfield in the VHT Capabilities Info field to 1; otherwise, the STA shall set the Tx Antenna Pattern Consistency subfield in the VHT Capabilities Info field to 0.

10.39.7 BSS basic VHT-MCS and NSS set operation

The BSS basic VHT-MCS and NSS set is the set of <VHT-MCS, NSS> tuples that are supported by all VHT STAs that are members of a VHT BSS. It is established by the STA that starts the VHT BSS, indicated by the Basic VHT-MCS and NSS Set field of the VHT Operation element in the MLME-START.request primitive. Other VHT STAs determine the BSS basic VHT-MCS and NSS set from the Basic VHT-MCS and NSS Set field of the VHT Operation element in the BSSDescription derived through the scan mechanism (see 10.1.4.1).

A VHT STA shall not attempt to join (MLME-JOIN.request) a BSS unless it supports (i.e., is able to both transmit and receive using) all the <VHT-MCS, NSS> tuples in the BSS basic VHT-MCS and NSS set.

A VHT STA shall not attempt to (re)associate (MLME-ASSOCIATE.request and MLME-REASSOCIATE.request) with a VHT AP unless the STA supports (i.e., is able to both transmit and receive using) all the <VHT-MCS, NSS> tuples in the Basic VHT-MCS and NSS Set field in the VHT Operation element transmitted by the AP.

10.40 Group ID management operation

An AP determines the possible combinations of STAs that can be addressed by a VHT MU PPDU by assigning STAs to groups and to specific user positions within those groups.

Assignments or changes of user positions corresponding to one or more Group IDs shall be performed using a Group ID Management frame defined in 8.5.23.3.

A STA may be assigned to multiple groups by setting multiple subfields of the Membership Status Array field (see 8.4.1.51) to 1 in the Group ID Management frame addressed to that STA.

A STA's user position in each group of which the STA is a member is indicated by the associated subfield in the User Position Array field (see 8.4.1.52) in the Group ID Management frame addressed to the STA. For each Group ID, an AP may assign the same user position to multiple STAs. A STA shall have only one user position in each group of which the STA is a member.

An AP may transmit a Group ID Management frame only if dot11VHTOptionImplemented is true. A Group ID Management frame shall not be sent to a VHT STA that does not have the MU Beamformee Capable field in the VHT Capabilities element equal to 1.

A Group ID Management frame shall be sent as an individually addressed frame.

A STA's MLME that receives a Group ID Management frame with a RA matching its MAC address shall issue a PHYCONFIG_VECTOR primitive with the GROUP_ID_MANAGEMENT parameter based on the content of the received Group ID Management frame in order to configure the following lookup tables in the PHY:

- a) group ID to Membership Status, denoted by MembershipStatusInGroupID[g] for $1 \leq g \leq 62$
- b) group ID to User Position, denoted by UserPositionInGroupID[g] for $1 \leq g \leq 62$

Group ID values of 0 and 63 are used for SU PPDU and the PHY filtering of such PPDUs is controlled by the PHYCONFIG_VECTOR primitive LISTEN_TO_GID00 and LISTEN_TO_GID63 parameters. The User Position in Group ID information is interpreted by a STA receiving a VHT MU PPDU as explained in 22.3.11.4.

Transmission of a Group ID Management frame to a STA and any associated acknowledgment from the STA shall complete before the transmission of a VHT MU PPDU to the STA.

A VHT MU PPDU shall be transmitted to a STA based on the content of the Group ID Management frame most recently transmitted to the STA and for which an acknowledgment was received.

10.41 Notification of operating mode changes

A STA whose dot11OperatingModeNotificationImplemented is true shall set the Operating Mode Notification field in the Extended Capabilities element to 1. A VHT STA shall set dot11OperatingModeNotificationImplemented to true. A STA that has the value true for dot11OperatingModeNotificationImplemented is referred to as *operating mode notification capable*.

A STA that is operating mode notification capable and that transmits an Association Request, Reassociation Request, TDLS Setup Response, TDLS Setup Confirm, Mesh Peering Open, or Mesh Peering Confirm frame to a STA that is operating mode notification capable should notify the recipient STA of a change in its operating mode by including the Operating Mode Notification element in the frame.

A first STA that is operating mode notification capable should notify a second STA that is operating mode notification capable of a change in its operating mode by transmitting an Operating Mode Notification frame to the second STA if the first STA has established any of the following with a second STA:

- An association with an AP
- A TDLS link
- A DLS link
- A Mesh Peer relationship

NOTE—Notify Channel Width frames and elements are used to signal STA operating channel width changes to and from STAs that are not operating mode notification capable.

The Operating Mode field in the Operating Mode Notification frame or the Operating Mode Notification element is set to indicate that the transmitting STA is capable of receiving frames with a bandwidth up to and including the indicated channel width and with a number of spatial streams up to and including the value indicated by the Rx NSS subfield.

The notification of a change in supported spatial streams should occur prior to a decrease in the maximum number of spatial streams and following an increase in the maximum number of spatial streams.

The notification of a change in operating bandwidth should occur prior to a decrease in the operating channel width and following an increase in the operating channel width.

A STA shall not transmit an individually addressed frame that contains the Operating Mode field unless the recipient is operating mode notification capable.

An AP should notify associated STAs of a change in the maximum number of spatial streams it is able to receive through one or more of the following mechanisms:

- Using individually addressed Operating Mode Notification frames
- Including the Operating Mode Notification element in Beacon frames for a period of time that ensures that STAs in PS mode will receive the notification
- Using the SM power save mechanism defined in 10.2.4 for HT STAs that are not operating mode notification capable

The notification should occur prior to a decrease in the maximum number of spatial streams and following an increase in the maximum number of spatial streams.

NOTE—An AP that is reducing the maximum number of spatial streams the AP is able to receive and that has associated HT STAs that are not operating mode notification capable would use the SM power save mechanism to notify the STAs that the AP is operating with a single receive chain.

An AP should notify associated STAs of a change in its operating channel width through one or more of the following mechanisms:

- Using the Channel Switch Announcement element, Channel Switch Announcement frame or both following the procedure defined in 10.9.8.2
- Using the Extended Channel Switch Announcement element, Extended Channel Switch Announcement frame or both, following the procedure described in 10.10
- Using individually addressed Operating Mode Notification frames and/or Notify Channel Width frames
- Using the STA Channel Width field in the HT Operation element and/or Channel Width field in the VHT Operation element

The notification should occur prior to a decrease in the operating channel width and following an increase in the operating channel width.

A VHT AP that has at least one VHT STA associated and that indicates a channel width change using management action frame(s) shall transmit Operating Mode Notification frame(s) to signal the channel width change. A VHT AP that has at least one non-VHT HT STA associated and that indicates a channel width change using management action frame(s) shall transmit Notify Channel Width frame(s) to signal the channel width change.

A VHT STA shall not transmit an individually addressed Notify Channel Width frame to a VHT STA.

A VHT STA associated with a VHT AP shall ignore Notify Channel Width frames received from the VHT AP.

An HT AP that is not a VHT AP that changes its operating channel width shall indicate the new operating channel width in the STA Channel Width field in the HT Operation element. A VHT AP that changes its operating channel width shall indicate the new operating channel width in the Channel Width field in the VHT Operation element and STA Channel Width field in the HT Operation element (see Table 10-19).

An AP shall not include the Operating Mode Notification element in Beacon, Probe Response, Association Response, and Reassociation Response frames when not changing the maximum number of spatial streams the AP is able to receive.

A STA shall not transmit an Operating Mode field with the value of the Rx NSS subfield indicating a number of spatial streams not supported by the recipient STA. The number of spatial streams supported by the recipient STA is reported in the Supported Rates element, Extended Supported Rates element, Supported MCS Set, or Supported VHT-MCS and NSS Set field transmitted in management frames by the recipient STA.

A STA shall not transmit an Operating Mode field with the value of the Channel Width subfield indicating a bandwidth not supported by the STA, as reported in the Supported Channel Width Set subfield in the HT Capabilities Info field or the VHT Capabilities Info field in management frames transmitted by the STA.

A STA that is operating mode notification capable shall not transmit a PPDU to a STA that uses a bandwidth that is greater than the channel width indicated in the most recently received Operating Mode Notification element or Operating Mode Notification frame from that STA. A STA that is operating mode notification capable shall not transmit a PPDU to a STA that uses a greater number of spatial streams than indicated in the most recently received Operating Mode Notification element or Operating Mode Notification frame received from that STA.

NOTE 1—To avoid possible frame loss, a VHT STA that sends an individually addressed Operating Mode Notification frame to a second VHT STA indicating reduced operating channel width and/or reduced active receive chains can continue with its current operating channel width and active receive chains until it infers that the second STA has processed this notification. The first VHT STA might make this inference from either of the following:

- By receiving a frame addressed to itself from the second VHT STA in a PPDU with a bandwidth and N_{SS} that are equal to or less than the channel width and N_{SS} , respectively, indicated in the Operating Mode Notification frame
- Based on the passage of time in some implementation dependent way, which is outside the scope of this standard

NOTE 2—It might take a long time for a STA to change its operating mode following the transmission of the Operating Mode Notification frame and during that time the STA might not be able to receive frames resulting in frame loss. If a non-AP STA cannot tolerate frame loss during that period it can set the Power Management subfield of the Frame Control field of the Operating Mode Notification frame to 1 to indicate that the STA has entered power save. When the non-AP STA has completed its operating mode change, it can send another frame (such as a QoS Null) with the Frame Control Power Management subfield set to 0 to indicate that the STA has exited power save.

11. Security

11.4 RSNA confidentiality and integrity protocols

11.4.3 CTR with CBC-MAC Protocol (CCMP)

11.4.3.1 General

Change the first paragraph of 11.4.3.1 as follows:

Subclause 11.4.3.1 specifies ~~the all variants of~~ CCMP, which provides data confidentiality, authentication, integrity, and replay protection. In a non-DMG network, CCMP-128 is mandatory for RSN compliance.

Change the third and fourth paragraphs in 11.4.3.1 (including creating a new fifth paragraph), and insert a new sixth paragraph as follows:

The AES algorithm is defined in FIPS PUB 197-2001. ~~All~~ AES processing used within CCMP uses AES with either a 128-bit key (CCMP-128) or a 256-bit key (CCMP-256) and a 128-bit block size.

CCM is defined in IETF RFC 3610. CCM is a generic mode that can be used with any block-oriented encryption algorithm. CCM has two parameters (M and L), ~~and~~

CCMP-128 uses the following values for the CCM parameters:

- $M = 8$; indicating that the MIC is 8 octets.
- $L = 2$; indicating that the Length field is 2 octets, which is sufficient to hold the length of the largest possible IEEE 802.11 MPDU, expressed in octets.

CCMP-256 uses the following values for the CCM parameters:

- $M = 16$; indicating that the MIC is 16 octets.
- $L = 2$; indicating that the Length field is 2 octets, which is sufficient to hold the length of the largest possible IEEE 802.11 MPDU, expressed in octets.

11.4.3.2 CCMP MPDU format

Change Figure 11-16 as follows:

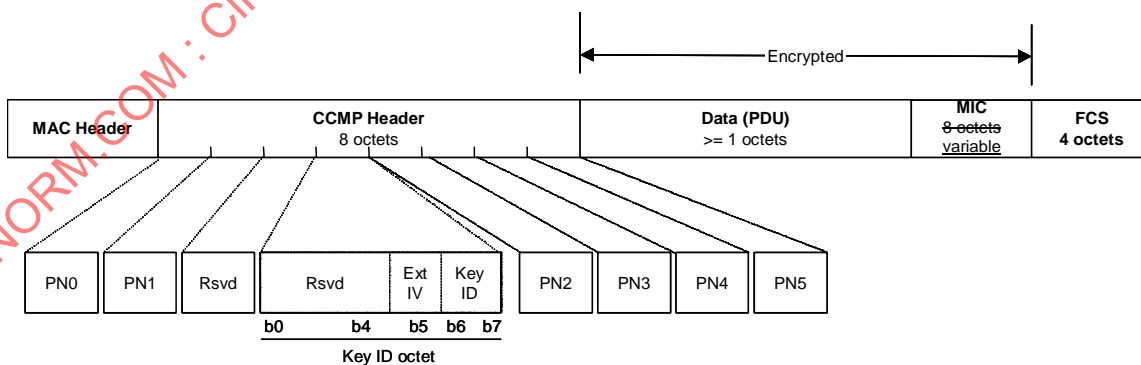

Figure 11-16—Expanded CCMP MPDU

Change the second paragraph of 11.4.3.2 as follows:

CCMP-128 processing expands the original MPDU size by 16 octets, 8 octets for the CCMP Header field and 8 octets for the MIC field. CCMP-256 processing expands the original MPDU size by 24 octets, 8 octets for the CCMP Header field, and 16 octets for the MIC field. The CCMP Header field is constructed from the PN, ExtIV, and Key ID subfields. PN is a 48-bit PN represented as an array of 6 octets. PN5 is the most significant octet of the PN, and PN0 is the least significant. Note that CCMP does not use the WEP ICV.

11.4.3.3 CCMP cryptographic encapsulation

11.4.3.3.6 CCM originator processing

Change the third paragraph of 11.4.3.3.6 as follows:

The CCM originator processing provides authentication and integrity of the frame body and the AAD as well as data confidentiality of the frame body. The output from the CCM originator processing consists of the encrypted data and ~~8 additional octets of an~~ encrypted MIC (see Figure 11-16).

11.4.3.4 CCMP decapsulation

11.4.3.4.2 CCM recipient processing

Change the second paragraph of 11.4.3.4.2 as follows:

There are four inputs to CCM recipient processing:

- *Key*: the temporal key (16 octets).
- *Nonce*: the nonce (13 octets) constructed as described in 11.4.3.3.4.
- *Encrypted frame body*: the encrypted frame body from the received MPDU. The encrypted frame body includes ~~the an 8-octet~~ MIC.
- *AAD*: the AAD (22-30 octets) that is the canonical MPDU header as described in 11.4.3.3.3.

11.4.4 Broadcast/Multicast Integrity Protocol (BIP)

11.4.4.1 BIP overview

Change 11.4.4.1 as follows:

BIP provides data integrity and replay protection for group addressed robust management frames after successful establishment of an IGTKSA (see 11.5.1.1.9).

BIP-CMAC-128 provides data integrity and replay protection, using AES-128 in CMAC Mode with a 128-bit integrity key and a CMAC TLen value of 128 (16 octets). BIP-CMAC-256 provides data integrity and replay protection, using AES-256 in CMAC Mode with a 256-bit integrity key and a CMAC TLen value of 128 (16 octets). NIST SP 800-38B defines the CMAC algorithm, and NIST SP 800-38D defines the GMAC algorithm. All BIP processing uses AES with a 128-bit or 256-bit integrity key and a 128-bit block size, and a CMAC TLen value of 128 (16 octets). The CMAC output for both BIP-CMAC-128 and BIP-CMAC-256 is truncated to 64 bits:

$$\text{MIC} = \text{L}(\text{CMAC Output}, 0, 64)$$

Where L is defined in 11.6.1.

BIP-GCMP-128 uses AES with a 128-bit integrity key, and BIP-GCMP-256 uses AES with a 256-bit integrity key. The authentication tag for both BIP-GCMP-128 and BIP-GCMP-256 is not truncated and shall be 128 bits (16 octets).

BIP uses the IGTK to compute the MMPDU MIC. The authenticator shall distribute one new IGTK and IGTK PN (IPN) whenever it distributes a new GTK. The IGTK is identified by the MAC address of the transmitting STA plus an IGTK identifier that is encoded in the MME Key ID field.

11.4.4.5 BIP transmission

Change 11.4.4.5 as follows:

When a STA transmits a protected group addressed robust management frame, it shall

- a) Select the IGTK currently active for transmission of frames to the intended group of recipients and construct the MME (see 8.4.2.57) with the MIC field masked to 0 and the KeyID field set to the corresponding IGTK KeyID value. If the frame is not a QQMF, the transmitting STA shall insert a monotonically increasing non-negative integer into the MME IPN field. If the frame is a QQMF, then the transmitting STA shall maintain a 48-bit counter for use as the IPN, the counter shall be incremented for each QQMF until the two least significant bits of the counter match the ACI of the AC that is used to transmit the frame, and the counter value shall be inserted into the MME IPN field of the frame. For BIP-GMAC-128 and BIP-GMAC-256, the initialization vector passed to GMAC shall be a concatenation of address 2 from the MAC header of the MPDU and the non-negative integer inserted into the MMP IPN field.
- b) Compute AAD as specified in 11.4.4.3.
- c) Compute an integrity value ~~AES-128-CMAC~~ over the concatenation of (AAD || Management Frame Body including MME), and insert the ~~64-bit~~ output into the MME MIC field. For BIP-CMAC-128, the integrity value is 64-bits and is computed using AES-128-CMAC; for BIP-CMAC-256, the integrity value is 128-bits and is computed using AES-256-CMAC; for BIP-GMAC-128, the integrity value is 128-bits and is computed using AES-128-GMAC; and, for BIP-GMAC-256, the integrity value is 128-bits and is computed using AES-256-GMAC.
- d) Compose the frame as the IEEE 802.11 header, management frame body, including MME, and FCS. The MME shall appear last in the frame body.
- e) Transmit the frame.

11.4.4.6 BIP reception

Change 11.4.4.6 as follows:

When a STA with management frame protection negotiated receives a group addressed robust management frame protected by BIP-CMAC-128, BIP-CMAC-256, BIP-GMAC-128, or BIP-GMAC-256, it shall

- a) Identify the appropriate IGTK key and associated state based on the MME KeyID field. If no such IGTK exists, silently drop the frame and terminate BIP processing for this reception.
- b) Perform replay protection on the received frame. The receiver shall interpret the MME IPN field as a 48-bit unsigned integer.
 - 1) If the frame is not a QQMF, the receiver shall compare this MME IPN integer value to the value of the receive replay counter for the IGTK identified by the MME Key ID field. If the integer value from the received MME IPN field is less than or equal to the replay counter value for this IGTK, the receiver shall discard the frame and increment the dot11RSNAStatsCMACReplays counter by 1.
 - 2) If the frame is a QQMF, the receiver shall compare this MME IPN integer value to the value of the receive replay counter for the IGTK identified by the MME Key ID field and the AC

represented by the value of the ACI subfield of the received frame. If the integer value from the received MME IPN field is less than or equal to the replay counter value for this IGTK and AC, the receiver shall discard the frame and increment the dot11RSNAStatsCMACReplays counter by 1.

~~If the received frame is not discarded after comparison of the MME IPN to the replay counter, the receiver shall extract and save the received MIC value, and compute the AES-128-CMAC over the concatenation of (AAD || Management Frame Body including MME) with the MIC field masked to 0 in the MME. If the result does not match the received MIC value, then the receiver shall discard the frame and increment the dot11RSNAStatsCMACICVErrors counter by 1. If replay protection fails, terminate BIP processing for this reception.~~

- c) Compute AAD for this management frame, as specified in 11.4.4.3. For BIP-GMAC-128 and BIP-GMAC-256, an initialization vector for GMAC is constructed as the concatenation of address 2 from the MAC header of the MPDU and the 48-bit unsigned integer from the MME IPN field.
- d) Extract and save the received MIC value, and compute ~~a verifier~~ the AES-128-CMAC over the concatenation of (AAD || Management Frame Body || MME) with the MIC field masked to 0 in the MME. For BIP-CMAC-128, the verifier is AES-128-CMAC; for BIP-CMAC-256, the integrity value is 128-bits and is computed using AES-256-CMAC; for BIP-GMAC-128, the verifier is AES-128-GMAC; and, for BIP-GMAC-256, the verifier is AES-256-GMAC. ~~If the result does not match the received MIC value, then the receiver shall discard the frame, increment the dot11RSNAStatsCMACICVErrors counter by 1, and terminate BIP processing for this reception.~~
- e) Update the replay counter for the IGTK identified by the MME Key ID field with the integer value of the MME IPN field if the frame is not a GQMF.
- f) Update the replay counter for the IGTK identified by the MME Key ID field and the AC represented by the value of the ACI subfield of the received frame with the integer value of the MME IPN field if the frame is a GQMF.

If management frame protection is negotiated, group addressed robust management frames that are received without BIP protection shall be discarded.

11.4.5 GCM with Galois Message Authentication Code (GMAC) Protocol (GCMP)

11.4.5.1 GCMP overview

Change the third paragraph of 11.4.5.1 as follows:

The AES algorithm is defined in FIPS PUB 197-2001. All AES processing used within GCMP uses AES with a 128-bit key (GCMP-128) or a 256-bit key (GCMP-256) ~~and a 128-bit block size.~~

11.5 RSNA security association management

11.5.3 RSNA policy selection in an ESS

Insert the following note after the third paragraph (“An SME initiating ...”) of 11.5.3:

NOTE—Because a VHT STA is also an HT STA, the elimination of TKIP also applies to VHT STAs.

11.5.5 RSNA policy selection in an IBSS and for DLS

Insert the following note after the existing note after the second paragraph of 11.5.5, and number the existing note “1”:

NOTE 2—Because a VHT STA is also an HT STA, the elimination of TKIP also applies to VHT STAs.

11.5.7 RSNA policy selection in an MBSS

Insert the following note at the end of 11.5.7:

NOTE—Because a VHT STA is also an HT STA, the elimination of TKIP also applies to VHT STAs.

11.6 Keys and key distribution

11.6.1 Key hierarchy

11.6.1.2 PRF

Change 11.6.1.2 as follows:

A PRF is used in a number of places in this standard. Depending on its use, it may need to output 128 bits, 192 bits, 256 bits, 384 bits, ~~or 512 bits,~~ or 704 bits. This subclause defines ~~six~~ five functions:

- PRF-128, which outputs 128 bits
- PRF-192, which outputs 192 bits
- PRF-256, which outputs 256 bits
- PRF-384, which outputs 384 bits
- PRF-512, which outputs 512 bits
- PRF-704, which outputs 704 bits

In the following, K is a key; A is a unique label for each different purpose of the PRF; B is a variable-length string; Y is a single octet containing 0; X is a single octet containing the loop parameter i ; and \parallel denotes concatenation:

$$\text{H-SHA-1}(K, A, B, X) \leftarrow \text{HMAC-SHA-1}(K, A \parallel Y \parallel B \parallel X)$$
$$\text{PRF}(K, A, B, \text{Len})$$
$$\text{for } i \leftarrow 0 \text{ to } (\text{Len}+159)/160 \text{ do}$$
$$R \leftarrow R \parallel \text{H-SHA-1}(K, A, B, i)$$
$$\text{return } L(R, 0, \text{Len})$$
$$\text{PRF-128}(K, A, B) = \text{PRF}(K, A, B, 128)$$
$$\text{PRF-192}(K, A, B) = \text{PRF}(K, A, B, 192)$$
$$\text{PRF-256}(K, A, B) = \text{PRF}(K, A, B, 256)$$
$$\text{PRF-384}(K, A, B) = \text{PRF}(K, A, B, 384)$$
$$\text{PRF-512}(K, A, B) = \text{PRF}(K, A, B, 512)$$

When the negotiated AKM is 00-0F-AC:5, ~~or 00-0F-AC:6,~~ or 00-0F-AC:11, the KDF specified in 11.6.1.7.2 (Key derivation function (KDF)) shall be used instead of the PRF construction defined here. In this case, A is used as the KDF label and B as the KDF Context, and the PRF functions are defined as follows:

$$\text{PRF-128}(K, A, B) = \text{KDF-SHA256-128}(K, A, B)$$
$$\text{PRF-192}(K, A, B) = \text{KDF-SHA256-192}(K, A, B)$$
$$\text{PRF-256}(K, A, B) = \text{KDF-SHA256-256}(K, A, B)$$
$$\text{PRF-384}(K, A, B) = \text{KDF-SHA256-384}(K, A, B)$$
$$\text{PRF-512}(K, A, B) = \text{KDF-SHA256-512}(K, A, B)$$

When the negotiated AKM is 00-0F-AC:12, the KDF specified in 11.6.1.7.2 shall be used instead of the PRF construction defined here. In this case, *A* is used as the KDF label and *B* as the KDF Context, and the PRF function is defined as follows:

$$\text{PRF-704}(K, A, B) = \text{KDF-SHA384-704}(K, A, B)$$

When the negotiated AKM is 00-0F-AC:13, the KDF specified in 11.6.1.7.2 shall be used instead of the PRF construction defined here. In this case, *A* is used as the KDF label and *B* as the KDF Context, and the PRF functions are defined as follows:

$$\text{PRF-384}(K, A, B) = \text{KDF-SHA384-384}(K, A, B)$$

$$\text{PRF-512}(K, A, B) = \text{KDF-SHA384-512}(K, A, B)$$

$$\text{PRF-704}(K, A, B) = \text{KDF-SHA384-704}(K, A, B)$$

11.6.1.3 Pairwise key hierarchy

Change 11.6.1.3 as follows:

Except when preauthentication is used, the pairwise key hierarchy utilizes PRF-384, ~~or PRF-512, or PRF-704~~ to derive session-specific keys from a PMK, as depicted in Figure 11-24 (Pairwise key hierarchy). ~~The PMK shall be 256 bits. When using AKM suite selector 00-0F-AC:12, the length of the PMK, PMK bits, shall be 384 bits. With all other AKM suite selectors, the length of the PMK, PMK bits, shall be 256 bits.~~ The pairwise key hierarchy takes a PMK and generates a PTK. The PTK is partitioned into KCK, KEK, and temporal keys, which are used by the MAC to protect individually addressed communication between the Authenticator's and Supplicant's respective STAs. PTKs are used between a single Supplicant and a single Authenticator.

Change Figure 11-24 as follows:

Replace “L(PTK, 0, 128) (KCK)” with “L(PTK, 0, KCK_bits) (KCK)” (one time)

Replace “L(PTK, 128, 128) (KEK)” with “L(PTK, KCK_bits, KEK_bits) (KEK)” (one time)

Replace “L(PTK, 256, TK_bits) (TK)” with “L(PTK, KCK_bits+KEK_bits, TK_bits) (TK)” (one time)

When not using a PSK, the PMK is derived from the MSK. The PMK shall be computed as the first ~~256 PMK bits~~ bits (bits 0–~~255~~PMK_bits–1) of the MSK: $\text{PMK} \leftarrow \text{L}(\text{MSK}, 0, \text{256PMK bits})$. ~~When this derivation is used, the MSK needs to consist of at least 256 bits.~~

The PTK shall not be used longer than the PMK lifetime as determined by the minimum of the PMK lifetime indicated by the AS, e.g., Session-Timeout + dot1xAuthTxPeriod or from dot11RSNAConfigPMKLifetime. When RADIUS is used and the Session-Timeout attribute is not in the RADIUS Accept message, and if the key lifetime is not otherwise specified, then the PMK lifetime is infinite.

NOTE 1—If the protocol between the Authenticator (or AP) and AS is RADIUS, then the MS-MPPE-Recv-Key attribute (vendor-id = 17; see Section 2.4.3 in IETF RFC 2548-1999 [B30]) is available to be used to transport the first 32 octets of the MSK to the AP, and the MS-MPPE-Send-Key attribute (vendor-id = 16; see Section 2.4.2 in IETF RFC 2548-1999 [B30]) is available to be used to transport the remaining 32 octets of the MSK.

NOTE 2—When reauthenticating and changing the pairwise key, a race condition might occur. If a frame is received while MLME-SETKEYS.request primitive is being processed, the received frame might be decrypted with one key and the MIC checked with a different key. Two possible options to avoid this race condition are as follows: the frame might be checked against the old MIC key, and the received frames might be queued while the keys are changed.

NOTE 3—If the AKMP is RSNA-PSK, then a 256-bit PSK might be configured into the STA and AP or a pass-phrase might be configured into the Supplicant or Authenticator. The method used to configure the PSK is outside this standard, but one method is via user interaction. If a pass-phrase is configured, then a 256-bit key is derived and used as the PSK. In any RSNA-PSK method, the PSK is used directly as the PMK. Implementations might support different PSKs for each pair of communicating STAs.

Here, the following assumptions apply:

- SNonce is a random or pseudorandom value contributed by the Supplicant; its value is taken when a PTK is instantiated and is sent to the PTK Authenticator.
- ANonce is a random or pseudorandom value contributed by the Authenticator.
- The PTK shall be derived from the PMK by

$$\text{PTK} \leftarrow \text{PRF-X}(\text{PMK}, \text{"Pairwise key expansion"}, \text{Min}(\text{AA}, \text{SPA}) \parallel \text{Max}(\text{AA}, \text{SPA}) \parallel \text{Min}(\text{ANonce}, \text{SNonce}) \parallel \text{Max}(\text{ANonce}, \text{SNonce}))$$

where $X = \text{KCK_bits} + \text{KEK_bits}_{256} + \text{TK_bits}$. The values of KCK bits and KEK bits are AKM suite dependent and are listed in Table 11-9 (Integrity and key wrap algorithms). The value of TK bits is cipher-suite dependent and is defined in Table 11-4 (Cipher suite key lengths). The Min and Max operations for IEEE 802 addresses are with the address converted to a positive integer treating the first transmitted octet as the most significant octet of the integer. The Min and Max operations for nonces are with the nonces treated as positive integers converted as specified in 8.2.2 (Conventions).

NOTE—The Authenticator and Supplicant normally derive a PTK only once per association. A Supplicant or an Authenticator uses the 4-Way Handshake to derive a new PTK. Both the Authenticator and Supplicant create a new nonce value for each 4-Way Handshake instance.

- The KCK shall be computed as the first KCK bits (bits 0 to KCK bits-1) of the PTK:

$$\text{KCK} \leftarrow \text{L}(\text{PTK}, 0, \text{KCK_bits})$$

The KCK is used by IEEE Std 802.1X-2004 to provide data origin authenticity in the 4-Way Handshake and Group Key Handshake messages.

- The KEK shall be computed as the next KEK bits (bits KCK bits to KCK bits + KEK bits-1) of the PTK:

$$\text{KEK} \leftarrow \text{L}(\text{PTK}, \text{KCK_bits}, \text{KCK_bits} + \text{KEK_bits})$$

The KEK is used by the EAPOL-Key frames to provide data confidentiality in the 4-Way Handshake and Group Key Handshake messages.

- The temporal key (TK) shall be computed as the next TK bits (bits KCK bits + KEK bits to KCK bits + KEK bits + TK bits-1) of the PTK:

$$\text{TK} \leftarrow \text{L}(\text{PTK}, \text{KCK_bits} + \text{KEK_bits}, \text{KCK_bits} + \text{KEK_bits} + \text{TK_bits})$$

The EAPOL-Key state machines (see 11.6.10 and 11.6.11) use the MLME-SETKEYS.request primitive to configure the temporal key into the STA. The STA uses the temporal key with the pairwise cipher suite; interpretation of this value is cipher-suite specific.

A PMK identifier is defined as

$$\text{PMKID} = \text{HMAC-SHA1-128}(\text{PMK}, \text{"PMK Name"} \parallel \text{AA} \parallel \text{SPA})$$

Here, HMAC-SHA1-128 is the first 128 bits of the HMAC-SHA1 of its argument list.

When the negotiated AKM is 00-0F-AC:5 or 00-0F-AC:6, HMAC-SHA-256 is used to calculate the PMKID, and the PMK identifier is defined as

$$\text{PMKID} = \text{Truncate-128}(\text{HMAC-SHA-256}(\text{PMK}, \text{"PMK Name"} \parallel \text{AA} \parallel \text{SPA}))$$

When the negotiated AKM is 00-0F-AC:11, HMAC-SHA-256 is used to calculate the PMKID, and the PMK identifier is defined as

$$\text{PMKID} = \text{Truncate-128}(\text{HMAC-SHA-256}(\text{KCK}, \text{"PMK Name"} \parallel \text{AA} \parallel \text{SPA}))$$

When the negotiated AKM is 00-0F-AC:12, HMAC-SHA-384 is used to calculate the PMKID, and the PMK identifier is defined as

$$\text{PMKID} = \text{Truncate-128}(\text{HMAC-SHA-384}(\text{KCK}, \text{"PMK Name"} \parallel \text{AA} \parallel \text{SPA}))$$

NOTE—When the PMKID is calculated for the PMKSA as part of RSN preauthentication, the AKM has not yet been negotiated. In this case, the HMAC-SHA1-128 based derivation is used for the PMKID calculation.

11.6.1.7 FT key hierarchy

11.6.1.7.2 Key derivation function (KDF)

Change 11.6.1.7.2 as follows:

The KDF for the FT key hierarchy, and for AKMs 00-0F-AC:11 and 00-0F-AC:12, is a variant of the pseudorandom function (PRF) defined in 11.6.1.2 and is defined as follows:

Output ← **KDF-Hash-Length (K, label, Context) where**

Input: *K*, a 256-bit key derivation key whose length equals the block size of the hash function
Hash, a cryptographically strong hash function
label, a string identifying the purpose of the keys derived using this KDF
Context, a bit string that provides context to identify the derived key
Length, the length of the derived key in bits

Output: a *Length*-bit derived key

result ← ""

iterations ← (*Length*+255)/256

do *i* = 1 **to** *iterations*

result ← *result* || HMAC-Hash₂₅₆(*K*, *i* || *label* || *Context* || *Length*)

od

return first *Length* bits of *result*, and securely delete all unused bits

In this algorithm, *i* and *Length* are encoded as 16-bit unsigned integers, represented using the bit ordering conventions of 8.2.2. *K*, *label*, and *Context* are bit strings and are represented using the ordering conventions of 8.2.2.

11.6.1.7.3 PMK-R0

Change the first paragraph of 11.6.1.7.3 (including its variable list) as follows:

The first-level key in the FT key hierarchy, PMK-R0, is derived using the KDF defined in 11.6.1.7.2. The PMK-R0 is the first level 256-bit keying material used to derive the next level keys (PMK-R1s):

R0-Key-Data = KDF-Hash-Z₃₈₄(XXKey, "FT-R0", SSIDlength || SSID || MDID || R0KHlength || R0KH-ID || S0KH-ID)

PMK-R0 = L(R0-Key-Data, 0, 256L)

PMK-R0Name-Salt = L(R0-Key-Data, 256L, 128)

where

- KDF-Hash-Z₃₈₄ is the KDF as defined in 11.6.1.7.2 used to generate a key of length 384 bits.
- L(-) is defined in 11.6.1
- If the AKM negotiated is 00-0F-AC:3, then Hash shall be SHA256, Z shall be 384, L shall be 256, and XXKey shall be the second 256 bits of the MSK (which is derived from the IEEE 802.1X

authentication), i.e., $XXKey = L(MSK, 256, 256)$. If the AKM negotiated is 00-0F-AC:4, then Hash shall be SHA256, Z shall be 384, L shall be 256, and XXKey shall be the PSK. If the AKM negotiated is 00-0F-AC:9, then Hash shall be SHA256, Z shall be 384, L shall be 256, and XXKey shall be the MPMK generated as the result of SAE authentication. If the AKM negotiated is 00-0F-AC:13, then Hash shall be SHA384, Z shall be 512, L shall be 384, and XXKey shall be the first 384 bits of the MSK (which is derived from the IEEE 802.1X authentication), i.e., $XXKey = L(MSK, 0, 384)$.

- "FT-R0" is 0x46 0x54 0x2D 0x52 0x30.
- SSIDlength is a single octet whose value is the number of octets in the SSID.
- SSID is the service set identifier, a variable length sequence of octets, as it appears in the Beacon and Probe Response frames.
- MDID is the Mobility Domain Identifier field from the MDE that was used during FT initial mobility domain association.
- R0KHlength is a single octet whose value is the number of octets in the R0KH-ID.
- R0KH-ID is the identifier of the holder of PMK-R0 in the Authenticator.
- S0KH-ID is the Supplicant's MAC address (SPA).

11.6.1.7.4 PMK-R1

Change the first paragraph of 11.6.1.7.4 (including its variable list) as follows:

The second-level key in the FT key hierarchy, PMK-R1, is a 256-bit key used to derive the PTK. The PMK-R1 is derived using the KDF defined in 11.6.1.7.2:

$$PMK-R1 = KDF-Hash-Z256(PMK-R0, "FT-R1", R1KH-ID \parallel S1KH-ID)$$

where

- ~~KDF-Hash-Z256 is the KDF as defined in 11.6.1.7.2 used to generate a key of length 256 bits.~~
- If the AKM negotiated is 00-0F-AC:3, 00-0F-AC:4, or 00-0F-AC:9, then Hash shall be SHA256, and Z shall be 256. If the AKM negotiated is 00-0F-AC:13, then Hash shall be SHA384, and Z shall be 384.
- PMK-R0 is the first level key in the FT key hierarchy.
- "FT-R1" is 0x46 0x54 0x2D 0x52 0x31.
- R1KH-ID is a MAC address of the holder of the PMK-R1 in the Authenticator of the AP.
- S1KH-ID is the SPA.

11.6.1.7.5 PTK

Change the first eight paragraphs of 11.6.1.7.5 as follows:

The third-level key in the FT key hierarchy is the PTK. This key is mutually derived by the S1KH and the R1KH used by the target AP, with the key length being a function of the negotiated cipher suite as defined by Table 11-4 in 11.6.2.

Using the KDF defined in 11.6.1.7.2, the PTK derivation is as follows:

$$PTK = KDF-Hash-PTKLen(PMK-R1, "FT-PTK", SNonce \parallel ANonce \parallel BSSID \parallel STA-ADDR)$$

where

- KDF-Hash-PTKLen is the KDF as defined in 11.6.1.7.2 used to generate a PTK of length PTKLen.

- If the AKM negotiated is 00-0F-AC:3, 00-0F-AC:4, or 00-0F-AC:9, then Hash shall be SHA256. If the AKM negotiated is 00-0F-A:13, then Hash shall be SHA384.
- PMK-R1 is the key that is shared between the S1KH and the R1KH.
- "FT-PTK" is 0x46 0x54 0x2D 0x50 0x54 0x4B.
- SNonce is a 256-bit random bit string contributed by the S1KH.
- ANonce is a 256-bit random bit string contributed by the R1KH.
- STA-ADDR is the non-AP STA's MAC address.
- BSSID is the BSSID of the target AP.
- PTKlen is the total number of bits to derive, i.e., number of bits of the PTK. The length is dependent on the negotiated cipher suites and AKM suites as defined by Table 11-4 in 11.6.2 and Table 11-9 in 11.6.3.

Each PTK has three component keys, KCK, KEK, and a temporal key, derived as follows:

The KCK shall be computed as the first ~~128~~KCK_bits bits (bits 0–~~127~~KCK_bits-1) of the PTK:

$$\text{KCK} = \text{L}(\text{PTK}, 0, \text{KCK_bits})$$

where L(-) is defined in 11.6.1.

The KCK is used to provide data origin authenticity in EAPOL-Key messages, as defined in 11.6.2, and in the FT authentication sequence, as defined in 12.8.

The KEK shall be computed as the next KEK_bits bits ~~bits 128–255~~ of the PTK:

$$\text{KEK} = \text{L}(\text{PTK}, \text{KCK_bits}, \text{KEK_bits})$$

The KEK is used to provide data confidentiality for certain fields (KeyData) in EAPOL-Key messages, as defined in 11.6.2, and in the FT authentication sequence, as defined in 12.8.

The temporal key (TK) shall be computed as the next TK_bits (see Table 11-4) ~~bits 256–383 (for CCMP)~~ of the PTK:

$$\text{TK} = \text{L}(\text{PTK}, \text{KCK_bits} + \text{KEK_bits}, \text{TK_bits})$$

11.6.2 EAPOL-Key frames

Change Table 11-4 as follows:

Table 11-4—Cipher suite key lengths

Cipher suite	Key length (octets)	TK_bits (bits)
WEP-40	5	40
WEP-104	13	104
TKIP	32	256
CCMP	16	128
BIP	16	128
<u>GCMP-128</u>	16	128
<u>GCMP-256</u>	<u>32</u>	<u>256</u>

Table 11-4—Cipher suite key lengths (continued)

Cipher suite	Key length (octets)	TK_bits (bits)
<u>CCMP-256</u>	<u>32</u>	<u>256</u>
<u>BIP-GMAC-128</u>	<u>16</u>	<u>128</u>
<u>BIP-GMAC-256</u>	<u>32</u>	<u>256</u>
<u>BIP-CMAC-256</u>	<u>32</u>	<u>256</u>

11.6.3 EAPOL-Key frame construction and processing

Change Table 11-9 as follows:

Table 11-9—Integrity and key-wrap algorithms

AKM	Integrity algorithm	<u>KCK bits</u>	Size of MIC	Key-wrap algorithm	<u>KEK bits</u>
Deprecated	HMAC-MD5	<u>128</u>	16	ARC4	<u>128</u>
00-0F-AC:1	HMAC-SHA1-128	<u>128</u>	16	NIST AES Key Wrap	<u>128</u>
00-0F-AC:2	HMAC-SHA1-128	<u>128</u>	16	NIST AES Key Wrap	<u>128</u>
00-0F-AC:3	AES-128-CMAC	<u>128</u>	16	NIST AES Key Wrap	<u>128</u>
00-0F-AC:4	AES-128-CMAC	<u>128</u>	16	NIST AES Key Wrap	<u>128</u>
00-0F-AC:5	AES-128-CMAC	<u>128</u>	16	NIST AES Key Wrap	<u>128</u>
00-0F-AC:6	AES-128-CMAC	<u>128</u>	16	NIST AES Key Wrap	<u>128</u>
<u>00-0F-AC:11</u>	<u>HMAC-SHA256</u>	<u>128</u>	<u>16</u>	<u>NIST AES Key Wrap</u>	<u>128</u>
<u>00-0F-AC:12</u>	<u>HMAC-SHA384</u>	<u>192</u>	<u>24</u>	<u>NIST AES Key Wrap</u>	<u>256</u>
<u>00-0F-AC:13</u>	<u>HMAC-SHA384</u>	<u>192</u>	<u>24</u>	<u>NIST AES Key Wrap</u>	<u>256</u>

11.7 Mapping EAPOL keys to IEEE 802.11 keys**11.7.7 Mapping IGTK to BIP keys**

Change 11.7.7 as follows:

See 11.6.1.5 for the definition of the IGTK key. A STA shall use bits 0–127 of the IGTK as the AES-128-CMAC key, bits 0–127 of the IGTK as the AES-128-GMAC key, and bits 0–255 of the IGTK as the AES-256-GMAC key.

13. MLME mesh procedures

13.2 Mesh discovery

13.2.4 Mesh STA configuration

Change 13.2.4 as follows:

The mesh STA configuration consists of the mesh profile (see 13.2.3), the Supported Rates element, the Extended Supported Rates element, ~~and the HT Operations element (if present), and the VHT Operations element (if present).~~

Mesh STA configurations are identical if the following conditions hold:

- The mesh profiles are identical.
- The BSSBasicRateSet parameters are identical.
- For HT mesh STAs, the BSSBasicMCSSet parameters are identical.
- For VHT mesh STAs, the Basic VHT-MCS and NSS fields in the VHT Operation element are identical.

13.2.7 Candidate peer mesh STA

Insert a new list item e) into the lettered list of the second paragraph of 13.2.7, and re-letter the subsequent list item accordingly:

- e) If both the scanning mesh STA and the discovered neighbor STA are VHT STAs, the mesh STA uses the same value for the Basic VHT-MCS and NSS Set field in its VHT Operation element as received in the Beacon or Probe Response frame from the neighbor mesh STA.

18. Orthogonal frequency division multiplexing (OFDM) PHY specification

18.2 OFDM PHY specific service parameter list

18.2.2 TXVECTOR parameters

18.2.2.1 General

Insert the following rows at the end of the Table 18-1:

Table 18-1—TXVECTOR parameters

Parameter	Associated primitive	Value
CH_BANDWIDTH_IN_NON_HT	PHY-TXSTART.request (TXVECTOR)	If present, CBW20, CBW40, CBW80, CBW160, or CBW80+80
DYN_BANDWIDTH_IN_NON_HT	PHY-TXSTART.request (TXVECTOR)	If present, Static or Dynamic

Insert the following subclauses, 18.2.2.7 and 18.2.2.8, after 18.2.2.6:

18.2.2.7 TXVECTOR CH_BANDWIDTH_IN_NON_HT

If present, the allowed values for CH_BANDWIDTH_IN_NON_HT are CBW20, CBW40, CBW80, CBW160, and CBW80+80. If present, this parameter is used to modify the first 7 bits of the scrambling sequence to indicate the bandwidth of the non-HT duplicate PPDU.

NOTE—The CH_BANDWIDTH_IN_NON_HT parameter is not present when the frame is transmitted by a non-VHT STA. The CH_BANDWIDTH_IN_NON_HT parameter is not present when the frame is transmitted by a VHT STA to a non-VHT STA. See 9.7.10.

18.2.2.8 TXVECTOR DYN_BANDWIDTH_IN_NON_HT

If present, the allowed values for DYN_BANDWIDTH_IN_NON_HT are Static and Dynamic. If present, this parameter is used to modify the first 7 bits of the scrambling sequence to indicate if the transmitter is capable of Static or Dynamic bandwidth operation. If DYN_BANDWIDTH_IN_NON_HT is present, then CH_BANDWIDTH_IN_NON_HT is also present.

NOTE—The DYN_BANDWIDTH_IN_NON_HT parameter is not present when the frame is transmitted by a non-VHT STA. The DYN_BANDWIDTH_IN_NON_HT parameter is not present when the frame is transmitted by a VHT STA to a non-VHT STA. See 9.7.10.

18.2.3 RXVECTOR parameters

18.2.3.1 General

Insert the following rows at the end of the Table 18-2:

Table 18-2—RXVECTOR parameters

Parameter	Associated primitive	Value
CH_BANDWIDTH_IN_NON_HT	PHY-RXSTART.request (RXVECTOR)	If present, CBW20, CBW40, CBW80, CBW160, or CBW80+80
DYN_BANDWIDTH_IN_NON_HT	PHY-RXSTART.request (RXVECTOR)	If present, Static or Dynamic

Insert the following subclauses, 18.2.3.7 and 18.2.3.8, after 18.2.3.6:

18.2.3.7 RXVECTOR CH_BANDWIDTH_IN_NON_HT

If present, the allowed values for CH_BANDWIDTH_IN_NON_HT are CBW20, CBW40, CBW80, CBW160, and CBW80+80. If present and valid, this parameter indicates the bandwidth of the non-HT duplicate PPDU. This parameter is used by the MAC only when valid (see 9.3.2.6 and 9.7.6.6).

NOTE—The CH_BANDWIDTH_IN_NON_HT parameter is not present when the frame is received by a non-VHT STA (see 9.7.10).

18.2.3.8 RXVECTOR DYN_BANDWIDTH_IN_NON_HT

If present, the allowed values for DYN_BANDWIDTH_IN_NON_HT are Static and Dynamic. If present and valid, this parameter indicates whether the transmitter is capable of Static or Dynamic bandwidth operation. This parameter is used by the MAC only when valid (see 9.3.2.6 and 9.7.6.6). If DYN_BANDWIDTH_IN_NON_HT is present, then CH_BANDWIDTH_IN_NON_HT is also present.

NOTE—The DYN_BANDWIDTH_IN_NON_HT parameter is not present when the frame is received by a non-VHT STA (see 9.7.10).

18.3 OFDM PLCP sublayer

18.3.2 PLCP frame format

18.3.2.2 Overview of the PPDU encoding process

Change step e) in the lettered list of the first paragraph of 18.3.2.2 as follows:

- e) If the TXVECTOR parameter CH BANDWIDTH IN NON HT is not present, initiate the scrambler with a pseudorandom nonzero seed; and generate a scrambling sequence. If the TXVECTOR parameter CH BANDWIDTH IN NON HT is present, construct the first 7 bits of the scrambling sequence from CH BANDWIDTH IN NON HT, DYN BANDWIDTH IN NON HT (if present), and a pseudorandom integer constrained such that the first 7 bits of the scrambling sequence are not all zeros; then set the scrambler state to these 7 bits and generate the remainder of the scrambling sequence. and XOR the scrambling sequence with the extended string of data bits. Refer to 18.3.5.5 for details.

the receiving PHY in a VHT STA always includes values for the CH BANDWIDTH IN NON HT and DYN BANDWIDTH IN NON HT parameters in the Clause 18 RXVECTOR. It is the responsibility of the MAC to determine the validity of the RXVECTOR parameters CH BANDWIDTH IN NON HT and DYN BANDWIDTH IN NON HT.

NOTE 2—The receiving PHY cannot determine whether the TXVECTOR parameter CH BANDWIDTH IN NON HT was present, but it does not matter since descrambling the DATA field is the same either way.

The seven LSBs of the SERVICE field shall be set to all zeros prior to scrambling to enable estimation of the initial state of the scrambler in the receiver.

An example of the scrambler output is illustrated in L.1.5.2 with CH BANDWIDTH IN NON HT not present.

Table 18-6a—Contents of the first 7 bits of the scrambling sequence

Parameter	Condition	First 7 bits of scrambling sequence				
		B0	B3	B4	B5	B6
TXVECTOR	CH_BANDWIDTH_IN_NON_HT is present and DYN_BANDWIDTH_IN_NOT_HT is not present in TXVECTOR	5-bit pseudorandom nonzero integer if CH_BANDWIDTH_IN_NON_HT equals CBW20 and a 5-bit pseudorandom integer otherwise			CH_BANDWIDTH_IN_NON_HT	
TXVECTOR	CH_BANDWIDTH_IN_NON_HT is present and DYN_BANDWIDTH_IN_NOT_HT is present in TXVECTOR	4-bit pseudorandom nonzero integer if CH_BANDWIDTH_IN_NON_HT equals CBW20 and DYN_BANDWIDTH_IN_NON_HT equals Static, and a 4-bit pseudorandom integer otherwise		DYN_BANDWIDTH_IN_NON_HT		
RXVECTOR	CH_BANDWIDTH_IN_NON_HT and DYN_BANDWIDTH_IN_NOT_HT are present in RXVECTOR	—		DYN_BANDWIDTH_IN_NON_HT		CbwInNonHtTemp is set to this subfield of first 7 bits of scrambling sequence; then CbwInNonHtTemp is mapped according to Table 18-6c to CH_BANDWIDTH_IN_NON_HT

Table 18-6b—TXVECTOR parameter CH_BANDWIDTH_IN_NON_HT values

Enumerated value	Value
CBW20	0
CBW40	1
CBW80	2
CBW160 or CBW80+80	3

Table 18-6c—RXVECTOR parameter CH_BANDWIDTH_IN_NON_HT values

CbwInNonHtTemp (see Table 18-6a)	dot11CurrentChannelCenter FrequencyIndex1	RXVECTOR parameter CH_BANDWIDTH_IN_NON_HT
0	0	CBW20
1	0	CBW40
2	0	CBW80
3	0	CBW160
3	1 to 200	CBW80+80

Table 18-6d—DYN_BANDWIDTH_IN_NON_HT values

Enumerated value	Value
Static	0
Dynamic	1

18.3.9 PMD transmit specifications

18.3.9.3 Transmit spectrum mask

Insert the following note after the existing note after the first paragraph of 18.3.9.3, and number the existing note "1":

NOTE 2—For rules regarding TX center frequency leakage levels by VHT STAs, see 22.3.18.4.2.

18.3.9.7 Modulation accuracy

18.3.9.7.2 Transmitter center frequency leakage

Insert the following paragraph at the beginning of 18.3.9.7.2:

For VHT STAs, the requirements on transmitter center frequency leakage are defined in 22.3.18.4.2; otherwise, the requirements are defined in this subclause.

19. Extended Rate PHY (ERP) specification

19.3 Extended Rate PLCP sublayer

19.3.3 PLCP data modulation and rate change

19.3.3.4 Long and short DSSS-OFDM PLCP format

19.3.3.4.1 General

Change 19.3.3.4.1 as follows:

The scrambler of 17.2.4 is used to scramble the DSSS-OFDM PLCP header, and, when the Clause 18 TXVECTOR parameters CH BANDWIDTH IN NON HT and DYN BANDWIDTH IN NON HT are not present, the scrambler in 18.3.5.5 is used to scramble the data symbols in the OFDM segment.

IECNORM.COM : Click to view the full PDF of ISO/IEC/IEEE 8802-11:2012/Amd.4:2015

20. High Throughput (HT) PHY specification

20.1 Introduction

20.1.1 Introduction to the HT PHY

Change the sixth paragraph of 20.1.1 as follows:

An HT ~~non-AP~~ STA shall support all equal modulation (EQM) rates for one spatial stream (MCSs 0 to 7) using 20 MHz channel width. An HT AP that is not a VHT AP shall support all EQM rates for ~~one and two~~ spatial streams (MCSs ~~0-8~~ to 15) using 20 MHz channel width.

20.3 HT PLCP sublayer

Change the title of 20.3.10 as follows:

20.3.10 Transmission of NON_HT format PPDUs with more than one ~~antenna~~ transmit chain

20.3.11 Data field

20.3.11.3 Scrambler

Change 20.3.11.3 as follows:

The data field shall be scrambled by the scrambler defined in 18.3.5.5 ~~and initialized with~~. The Clause 18 TXVECTOR parameters CH BAND-WIDTH IN NON HT and DYN BANDWIDTH IN NON HT shall not be present; therefore, the initial state of the scrambler shall be set to a pseudorandom nonzero seed.

20.3.20 PMD transmit specification

20.3.20.1 Transmit spectrum mask

Insert the following note after Note 2 at the beginning of 20.3.20.1:

NOTE 3—For rules regarding TX center frequency leakage levels by VHT STAs, see 22.3.18.4.2.

20.3.20.7 Modulation accuracy

20.3.20.7.2 Transmit center frequency leakage

Insert the following paragraph at the beginning of 20.3.20.7.2:

For VHT STAs the requirements on transmitter center frequency leakage are defined in 22.3.18.4.2; otherwise, the requirements are defined in this subclause.

Insert the following text, Clause 22, after Clause 21:

22. Very High Throughput (VHT) PHY specification

22.1 Introduction

22.1.1 Introduction to the VHT PHY

Clause 22 specifies the PHY entity for a very high throughput (VHT) orthogonal frequency division multiplexing (OFDM) system.

In addition to the requirements in Clause 22, a VHT STA shall be capable of transmitting and receiving PPDU that are compliant with the mandatory PHY specifications defined in Clause 20.

The VHT PHY is based on the HT PHY defined in Clause 20, which in turn is based on the OFDM PHY defined in Clause 18. The VHT PHY extends the maximum number of space-time streams supported to eight and provides support for downlink multi-user (MU) transmissions. A downlink MU transmission supports up to four users with up to four space-time streams per user with the total number of space-time streams not exceeding eight.

NOTE—A VHT SU PPDU includes individually addressed and group addressed transmissions.

The VHT PHY provides support for 20 MHz, 40 MHz, 80 MHz, and 160 MHz contiguous channel widths and support for 80+80 MHz noncontiguous channel width.

The VHT PHY data subcarriers are modulated using binary phase shift keying (BPSK), quadrature phase shift keying (QPSK), 16-quadrature amplitude modulation (16-QAM), 64-QAM, and 256-QAM. Forward error correction (FEC) coding (convolutional or LDPC coding) is used with coding rates of 1/2, 2/3, 3/4, and 5/6.

A VHT STA shall support the following features:

- Non-HT and non-HT duplicate formats (transmit and receive) for all channel widths supported by the VHT STA
- HT-mixed format (transmit and receive)
- VHT format (transmit and receive)
- 20 MHz, 40 MHz, and 80 MHz channel widths
- Single spatial stream VHT-MCSs 0 to 7 (transmit and receive) in all supported channel widths
- Binary convolutional coding

A VHT STA may support the following features:

- HT-greenfield format (transmit and receive)
- 2 or more spatial streams (transmit and receive)
- 400 ns short guard interval (transmit and receive)
- Beamforming sounding (by sending a VHT NDP)
- Responding to transmit beamforming sounding (by providing compressed beamforming feedback)
- STBC (transmit and receive)
- LDPC (transmit and receive)
- VHT MU PPDU (transmit and receive)

- Support for 160 MHz channel width
- Support for 80+80 MHz channel width
- VHT-MCSs 8 and 9 (transmit and receive)

22.1.2 Scope

The services provided to the MAC by the VHT PHY consist of the following protocol functions:

- a) A function that defines a method of mapping the PSDUs into a framing format (PPDU) suitable for sending and receiving PSDUs between two or more STAs.
- b) A function that defines the characteristics and method of transmitting and receiving data through a wireless medium between two or more STAs. Depending on the PPDU format, these STAs support a mixture of VHT: Clause 20 and Clause 18 PHYs.

22.1.3 VHT PHY functions

22.1.3.1 General

The VHT PHY contains two functional entities: the PHY function and the physical layer management function (i.e., the PLME). Both of these functions are described in detail in 22.3 and 22.4.

The VHT PHY service is provided to the MAC through the PHY service primitives defined in Clause 7. The VHT PHY service interface is described in 22.2.

22.1.3.2 PHY management entity (PLME)

The PLME performs management of the local PHY functions in conjunction with the MLME.

22.1.3.3 Service specification method

The models represented by figures and state diagrams are intended to be illustrations of the functions provided. It is important to distinguish between a model and a real implementation. The models are optimized for simplicity and clarity of presentation; the actual method of implementation is left to the discretion of the VHT-PHY-compliant developer.

The service of a layer is the set of capabilities that it offers to a user in the next higher layer. Abstract services are specified here by describing the service primitives and parameters that characterize each service. This definition is independent of any particular implementation.

22.1.4 PPDU formats

The structure of the PPDU transmitted by a VHT STA is determined by the TXVECTOR parameters as defined in Table 22-1.

For a VHT STA, the FORMAT parameter determines the overall structure of the PPDU and includes the following:

- Non-HT format (NON_HT), based on Clause 18 and including non-HT duplicate format.
- HT-mixed format (HT_MF) as specified in Clause 20.
- HT-greenfield format (HT_GF) as specified in Clause 20.
- VHT format (VHT). PPDUs of this format contain a preamble compatible with Clause 18 and Clause 20 STAs. The non-VHT portion of the VHT format preamble (the parts of VHT preamble preceding the VHT-SIG-A field) is defined so that it can be decoded by these STAs.

NOTE—Required support for these formats is defined in 10.39, 20.1.1, and 22.1.1.

A VHT PPDU can be further categorized as a VHT SU PPDU or a VHT MU PPDU. A VHT PPDU using a group ID value of 0 or 63 is a VHT SU PPDU and either carries only one PSDU or no PSDU. A VHT PPDU using a group ID value in the range of 1 to 62 is a VHT MU PPDU and carries one or more PSDUs to one or more users.

22.2 VHT PHY service interface

22.2.1 Introduction

The PHY provides an interface to the MAC through an extension of the generic PHY service interface defined in 7.3.4 (Basic service and options). The interface includes TXVECTOR, RXVECTOR, and PHYCONFIG_VECTOR.

The TXVECTOR supplies the PHY with per-PPDU transmit parameters. Using the RXVECTOR, the PHY informs the MAC of the received PPDU parameters. Using the PHYCONFIG_VECTOR, the MAC configures the PHY for operation, independent of frame transmission or reception.

22.2.2 TXVECTOR and RXVECTOR parameters

The parameters in Table 22-1 are defined as part of the TXVECTOR parameter list in the PHY-TXSTART.request primitive and/or as part of the RXVECTOR parameter list in the PHY-RXSTART.indication primitive.

Table 22-1—TXVECTOR and RXVECTOR parameters

Parameter	Condition	Value	TXVECTOR	RXVECTOR
FORMAT		Determines the format of the PPDU. Enumerated type: NON_HT indicates Clause 18 (Orthogonal frequency division multiplexing (OFDM) PHY specification) or non-HT duplicated PPDU format. In this case, the modulation is determined by the NON_HT_MODULATION parameter. HT_MF indicates HT-mixed format. HT_GF indicates HT-greenfield format. VHT indicates VHT format.	Y	Y
NON_HT_MODULATION	FORMAT is NON_HT	In TXVECTOR, indicates the format type of the transmitted non-HT PPDU. In RXVECTOR, indicates the estimated format type of the received non-HT PPDU. Enumerated type: OFDM indicates Clause 18 (Orthogonal frequency division multiplexing (OFDM) PHY specification) format NON_HT_DUP_OFDM indicates non-HT duplicate format	Y	Y
	Otherwise	Not present	N	N

Table 22-1—TXVECTOR and RXVECTOR parameters (continued)

Parameter	Condition	Value	TXVECTOR	RXVECTOR
L_LENGTH	FORMAT is NON_HT	Indicates the length of the PSDU in octets in the range of 1 to 4095. This value is used by the PHY to determine the number of octet transfers that occur between the MAC and the PHY.	Y	Y
	FORMAT is HT_MF	Indicates the value in the Length field of the L-SIG in the range of 1 to 4095.	Y	Y
	FORMAT is HT_GF	Not present	N	N
	FORMAT is VHT	Not present NOTE—The Length field of the L-SIG in VHT PPDU is defined in Equation (22-24) using the TXTIME value defined by Equation (22-109) and Equation (22-110), which in turn depend on other parameters including the TXVECTOR parameter APEP_LENGTH.	N	N
L_DATARATE	FORMAT is NON_HT	Indicates the data rate used to transmit the PSDU in Mb/s. The allowed values are 6, 9, 12, 18, 24, 36, 48, and 54.	Y	Y
	FORMAT is HT_MF	Indicates the data rate value that is encoded in the L-SIG Rate field. This use is defined in 9.23.4 (L_LENGTH and L_DATARATE parameter values for HT-mixed PPDU).	Y	Y
	FORMAT is HT_GF	Not present	N	N
	FORMAT is VHT	Not present NOTE—The RATE field in the L-SIG field in a VHT PPDU is set to the value representing 6 Mb/s in the 20 MHz channel spacing column of Table 18-6 (Contents of the SIGNAL field).	N	N
LSIGVALID	FORMAT is VHT	Not present	N	N
	Otherwise	See corresponding entry in Table 20-1		
SERVICE	FORMAT is VHT	Not present	N	N
	Otherwise	See corresponding entry in Table 20-1		
SMOOTHING	FORMAT is VHT	Not present	N	N
	Otherwise	See corresponding entry in Table 20-1		
AGGREGATION	FORMAT is VHT	Not present	N	N
	Otherwise	See corresponding entry in Table 20-1		

Table 22-1—TXVECTOR and RXVECTOR parameters (continued)

Parameter	Condition	Value	TXVECTOR	RXVECTOR
NUM_EXTEN_SS	FORMAT is VHT	Not present	N	N
	Otherwise	See corresponding entry in Table 20-1		
ANTENNA_SET	FORMAT is VHT	Not present	N	N
	Otherwise	See corresponding entry in Table 20-1		
N_TX	FORMAT is HT_MF, HT_GF or VHT	Indicates the number of transmit chains	Y	N
	Otherwise	Not present	N	N
EXPANSION_MAT_TYPE	FORMAT is VHT and EXPANSION_MAT is present.	Set to COMPRESSED_SV	Y	N
	Otherwise	See corresponding entry in Table 20-1		
EXPANSION_MAT	FORMAT is VHT	Contains a vector in the number of selected subcarriers containing feedback matrices as defined in 22.3.11.2 based on the channel measured during the training symbols of a previous VHT NDP PPDU.	M U	N
	Otherwise	See corresponding entry in Table 20-1		
CHAN_MAT_TYPE	FORMAT is VHT and PSDU_LENGTH equals 0	Set to COMPRESSED_SV	N	Y
	FORMAT is VHT and PSDU_LENGTH is greater than 0	Not present	N	N
	Otherwise	See corresponding entry in Table 20-1		

Table 22-1—TXVECTOR and RXVECTOR parameters (continued)

Parameter	Condition	Value	TXVECTOR	RXVECTOR
CHAN_MAT	FORMAT is VHT and PSDU_LENGTH equals 0	Contains a set of compressed beamforming feedback matrices as defined in 22.3.11.2 based on the channel measured during the training symbols of the received VHT NDP PPDU.	N	Y
	FORMAT is VHT and PSDU_LENGTH is greater than 0	Not present	N	N
	Otherwise	See corresponding entry in Table 20-1		
DELTA_SNR	FORMAT is VHT	Contains an array of delta SNR values as defined in 8.4.1.49 based on the channel measured during the training symbols of the received VHT NDP PPDU. NOTE—In the RXVECTOR this parameter is present only for VHT NDP PPDU's for MU sounding.	M U	Y
	Otherwise	Not present	N	N
RCPI		Is a measure of the received RF power averaged over all the receive chains in the Data field of a received PPDU. Refer to 20.3.21.6 for the definition of RCPI.	N	Y
SNR	FORMAT is VHT	Contains an array of received SNR measurements for each spatial stream. SNR indications of 8 bits are supported. SNR shall be the sum of the decibel values of SNR per tone divided by the number of tones represented in each stream as described in 8.4.1.48	N	Y
	Otherwise	See corresponding entry in Table 20-1		
NO_SIG_EXTN	FORMAT is VHT	Not present	N	N
	Otherwise	See corresponding entry in Table 20-1		
FEC_CODING	FORMAT is VHT	Indicates which FEC encoding is used. Enumerated type: BCC_CODING indicates binary convolutional code. LDPC_CODING indicates low-density parity check code.	M U	Y
	Otherwise	See corresponding entry in Table 20-1		
STBC	FORMAT is VHT	Indicates whether STBC is used. 0 indicates no STBC ($N_{STS}=N_{SS}$ in the Data field). 1 indicates STBC is used ($N_{STS}=2N_{SS}$ in the Data field). This parameter is 0 for a VHT MU PPDU.	Y	Y
	Otherwise	See corresponding entry in Table 20-1		

Table 22-1—TXVECTOR and RXVECTOR parameters (continued)

Parameter	Condition	Value	TXVECTOR	RXVECTOR
GI_TYPE	FORMAT is HT_MF, HT_GF or VHT	Indicates whether a short guard interval is used in the transmission of the Data field of the PPDU. Enumerated type: LONG_GI indicates short GI is not used in the Data field of the PPDU. SHORT_GI indicates short GI is used in the Data field of the PPDU.	Y	Y
	Otherwise	Not present	N	N
TXPWR_LEVEL	FORMAT is VHT	The allowed values for the TXPWR_LEVEL parameter are in the range from 1 to $\text{numberOfOctets}(\text{dot11TxPowerLevelExtended})/2$. This parameter is used to indicate which of the available transmit output power levels defined in dot11TxPowerLevelExtended shall be used for the current transmission.	Y	N
	Otherwise	See corresponding entry in Table 20-1		
RSSI	FORMAT is VHT	The allowed values for the RSSI parameter are in the range 0 to 255 inclusive. This parameter is a measure by the PHY of the power observed at the antennas used to receive the current PPDU measured during the reception of the VHT-LTF field. RSSI is intended to be used in a relative manner, and it is a monotonically increasing function of the received power.	N	Y
	Otherwise	See corresponding entry in Table 20-1		
MCS	FORMAT is VHT	Indicates the modulation and coding scheme used in the transmission of the PPDU. Integer: range 0 to 9	M U	Y
	Otherwise	See corresponding entry in Table 20-1		
REC_MCS	FORMAT is HT_MF, HT_GF or VHT	Indicates the MCS that the STA's receiver recommends.	N	O
	Otherwise	Not present	N	N

Table 22-1—TXVECTOR and RXVECTOR parameters (continued)

Parameter	Condition	Value	TXVECTOR	RXVECTOR
CH_BANDWIDTH	FORMAT is HT_MF or HT_GF	See corresponding entry in Table 20-1		
	FORMAT is VHT	Indicates the channel width of the transmitted PPDU: Enumerated type: CBW20 for 20 MHz CBW40 for 40 MHz CBW80 for 80 MHz CBW160 for 160 MHz CBW80+80 for 80+80 MHz	Y	Y
	FORMAT is NON_HT	In TXVECTOR, indicates the channel width of the transmitted PPDU. In RXVECTOR, indicates the estimated channel width of the received PPDU. Enumerated type: CBW40, CBW80, CBW160, or CBW80+80 if NON_HT_MODULATION equals NON_HT_DUP_OFDM CBW20 if NON_HT_MODULATION equals OFDM	Y	Y
DYN_BANDWIDTH_IN_NON_HT	FORMAT is NON_HT	In TXVECTOR, if present, indicates whether the transmitter is capable of Static or Dynamic bandwidth operation. In RXVECTOR, if valid, indicates whether the transmitter is capable of Static or Dynamic bandwidth operation. Enumerated type: Static if the transmitter is capable of Static bandwidth operation Dynamic if the transmitter is capable of Dynamic bandwidth operation NOTE—In the RXVECTOR, the validity of this parameter is determined by the MAC based on the contents of the received MPDU.	O	Y
	Otherwise	Not present	N	N
CH_BANDWIDTH_IN_NON_HT	FORMAT is NON_HT	In TXVECTOR, if present, indicates the channel width of the transmitted PPDU, which is signaled via the scrambling sequence. In RXVECTOR, if valid, indicates the channel width of the received PPDU, which is signaled via the scrambling sequence. Enumerated type: CBW20, CBW40, CBW80, CBW160, CBW80+80 NOTE—In the RXVECTOR, the validity of this parameter is determined by the MAC based on the contents of the currently received MPDU (e.g. RTS) or the previous MPDU in an exchange (e.g., the RTS preceding a CTS).	O	Y
	Otherwise	Not present	N	N
LENGTH	FORMAT is HT_MF or HT_GF	See corresponding entry in Table 20-1		
	Otherwise	Not present	N	N

Table 22-1—TXVECTOR and RXVECTOR parameters (continued)

Parameter	Condition	Value	TXVECTOR	RXVECTOR
APEP_LENGTH	FORMAT is VHT	<p>If equal to 0, indicates a VHT NDP PPDU for both RXVECTOR and TXVECTOR.</p> <p>If greater than 0 in the TXVECTOR, indicates the number of octets in the range 1 to 1 048 575 in the A-MPDU pre-EOF padding (see 9.12.2) carried in the PSDU. This parameter is used to determine the number of OFDM symbols in the Data field that do not appear after a subframe with 1 in the EOF subfield and, after being rounded up to a 4 octet boundary with the two LSBs removed, is placed in the VHT-SIG-B Length field.</p> <p>NOTE—The rounding up of the APEP_LENGTH parameter to a 4-octet word boundary could result in a value that is larger than the PSDU_LENGTH calculated using the equations in 22.4.3.</p> <p>If greater than 0 in the RXVECTOR, this parameter is the value obtained from the VHT-SIG-B Length field multiplied by 4.</p>	M U	O
	Otherwise	Not present	N	N
PSDU_LENGTH	FORMAT is VHT	Indicates the number of octets in the VHT PSDU in the range of 0 to 1 048 575 octets. A value of 0 indicates a VHT NDP PPDU.	N	Y
	Otherwise	Not present	N	N
USER_POSITION	FORMAT is VHT and $1 \leq \text{GROUP_ID} \leq 62$	<p>Index for user in MU transmission. Integer: range 0-3.</p> <p>NOTE—The entries in the USER_POSITION array are in ascending order.</p>	M U	O
	Otherwise	Not present	N	N
NUM_STS	FORMAT is VHT	<p>Indicates the number of space-time streams.</p> <p>Integer: range 1-8 for SU, 1-4 per user in the TXVECTOR and 0-4 in the RXVECTOR for MU.</p> <p>NUM_STS summed over all users is in the range 1 to 8.</p>	M U	Y
	Otherwise	Not present	N	N
GROUP_ID	FORMAT is VHT	<p>Indicates the group ID.</p> <p>Integer: range 0-63 (see Table 22-12)</p> <p>A value of 0 or 63 indicates a VHT SU PPDU. A value in the range 1 to 62 indicates a VHT MU PPDU.</p>	Y	Y
	Otherwise	Not present	N	N
PARTIAL_AID	FORMAT is VHT and GROUP_ID is 0 or 63	<p>Provides an abbreviated indication of the intended recipient(s) of the PSDU (see 9.17a).</p> <p>Integer: range 0-511.</p>	Y	Y
	Otherwise	Not present	N	N

Table 22-1—TXVECTOR and RXVECTOR parameters (continued)

Parameter	Condition	Value	TXVECTOR	RXVECTOR
NUM_USERS	FORMAT is VHT	Indicates the number of users with non-zero space-time streams. Integer: range 1 to 4.	Y	N
	Otherwise	Not present	N	N
BEAMFORMED	FORMAT is VHT and GROUP_ID is 0 or 63	Set to 1 if a beamforming steering matrix is applied to the waveform in an SU transmission as described in 20.3.11.11.2. Set to 0 otherwise. NOTE—When BEAMFORMED is set to 1, smoothing is not recommended.	Y	O
	Otherwise	Not present	N	N
TXOP_PS_NOT_ALLOWED	FORMAT is VHT	Indicates whether a VHT AP allows non-AP VHT STAs in TXOP power save mode to enter Doze state during the TXOP. 0 indicates that the VHT AP allows non-AP VHT STAs to enter doze mode during a TXOP. 1 indicates that the VHT AP does not allow non-AP VHT STAs to enter doze mode during a TXOP.	Y	Y
	Otherwise	Not present	N	N
TIME_OF_DEPARTURE_REQUESTED		Boolean value: True indicates that the MAC entity requests that the PHY entity measures and reports time of departure parameters corresponding to the time when the first PPDU energy is sent by the transmitting port. False indicates that the MAC entity requests that the PHY entity neither measures nor reports time of departure parameters.	O	N

Table 22-1—TXVECTOR and RXVECTOR parameters (continued)

Parameter	Condition	Value	TXVECTOR	RXVECTOR
RX_START_OF_FRAME_OFFSET	dot11MgmtOptionTiming MsmtActivated is true	0 to $2^{32}-1$. An estimate of the offset (in 10 ns units) from the point in time at which the start of the preamble corresponding to the incoming frame arrived at the receive antenna port to the point in time at which this primitive is issued to the MAC.	N	Y
	Otherwise	Not present	N	N
<p>NOTE 1—In the “TXVECTOR” and “RXVECTOR” columns, the following apply: Y = Present; N = Not present; O = Optional; MU indicates that the parameter is present once for a VHT SU PPDU and present per user for a VHT MU PPDU. Parameters specified to be present per user are conceptually supplied as an array of values indexed by u, where u takes values 0 to NUM_USERS-1.</p> <p>NOTE 2—On reception, where valid, the CH_BANDWIDTH_IN_NON_HT parameter is likely to be a more reliable indication of subformat and channel width than the NON_HT_MODULATION and CH_BANDWIDTH parameters, since for non-HT or non-HT duplicate frames, CH_BANDWIDTH is a receiver estimate of the bandwidth, whereas CH_BANDWIDTH_IN_NON_HT is the signaled bandwidth.</p>				

22.2.3 Effects of CH_BANDWIDTH parameter on PPDU format

Table 22-2 shows the PPDU format as a function of the CH_BANDWIDTH parameter.

Table 22-2—PPDU format as a function of CH_BANDWIDTH parameter

FORMAT	NON_HT_MODULATION	CH_BANDWIDTH	PPDU format
VHT, HT_MF or HT_GF		CBW20	The STA transmits an HT-mixed PPDU (when FORMAT is HT_MF) or HT-greenfield PPDU (when FORMAT is HT_GF) or VHT PPDU (when FORMAT is VHT) of 20 MHz bandwidth. If the operating channel width is wider than 20 MHz, then the transmission shall use the primary 20 MHz channel.
VHT, HT_MF or HT_GF		CBW40	The STA transmits an HT-mixed PPDU (when FORMAT is HT_MF) or HT-greenfield PPDU (when FORMAT is HT_GF) or VHT PPDU (when FORMAT is VHT) of 40 MHz bandwidth. If the operating channel width is wider than 40 MHz, then the transmission shall use the primary 40 MHz channel.

Table 22-2— PPDU format as a function of CH_BANDWIDTH parameter (continued)

FORMAT	NON_HT_MODULATION	CH_BANDWIDTH	PPDU format
VHT		CBW80	The STA transmits a VHT PPDU of 80 MHz bandwidth. If the operating channel width is 160 MHz or 80+80 MHz, then the transmission shall use the primary 80 MHz channel.
VHT		CBW160	The STA transmits a VHT PPDU of 160 MHz bandwidth.
VHT		CBW80+80	The STA transmits a VHT PPDU of 80+80 MHz bandwidth.
NON_HT	OFDM	CBW20	The STA transmits a NON_HT PPDU with NON_HT_MODULATION set to OFDM using the primary 20 MHz channel as defined in Clause 18.
NON_HT	NON_HT_DUP_OFDM	CBW40	The STA transmits a NON_HT PPDU with NON_HT_MODULATION set to NON_HT_DUP_OFDM using two adjacent 20 MHz channels as defined in 22.3.10.12. If the operating channel width is wider than 40 MHz, then the transmission shall use the primary 40 MHz channel. The one 20 MHz channel higher in frequency is rotated +90° relative to the 20 MHz channel lowest in frequency as defined in Equation (22-15).
NON_HT	NON_HT_DUP_OFDM	CBW80	The STA transmits a NON_HT PPDU with NON_HT_MODULATION set to NON_HT_DUP_OFDM using four adjacent 20 MHz channels as defined in 22.3.10.12. If the BSS operating channel width is 160 MHz or 80+80 MHz, then the transmission shall use the primary 80 MHz channel. The three 20 MHz channels higher in frequency are rotated +180° relative to the 20 MHz channel lowest in frequency as defined in Equation (22-16).
NON_HT	NON_HT_DUP_OFDM	CBW160	The STA transmits a NON_HT PPDU with NON_HT_MODULATION set to NON_HT_DUP_OFDM using eight adjacent 20 MHz channels as defined in 22.3.10.12. The second, third, fourth, sixth, seventh, and eighth 20 MHz channels in the order of increasing frequency are rotated +180° relative to the 20 MHz channel lowest in frequency as defined in Equation (22-17).
NON_HT	NON_HT_DUP_OFDM	CBW80+80	The STA transmits a NON_HT PPDU with NON_HT_MODULATION set to NON_HT_DUP_OFDM using two non-adjacent frequency segments, with each frequency segment consisting of four adjacent 20 MHz channels as defined in 22.3.10.12. In each frequency segment, the three 20 MHz channels higher in frequency are rotated +180° relative to the 20 MHz channel lowest in frequency as defined in Equation (22-16).

22.2.4 Support for NON_HT and HT formats

22.2.4.1 General

A VHT STA logically contains Clause 18, Clause 20, and Clause 22 PHYs. The MAC interfaces to the PHYs via the Clause 22 PHY service interface, which in turn interacts with the Clause 18 and Clause 20 PHY service interfaces as shown in Figure 22-1, Figure 22-2, and Figure 22-3.

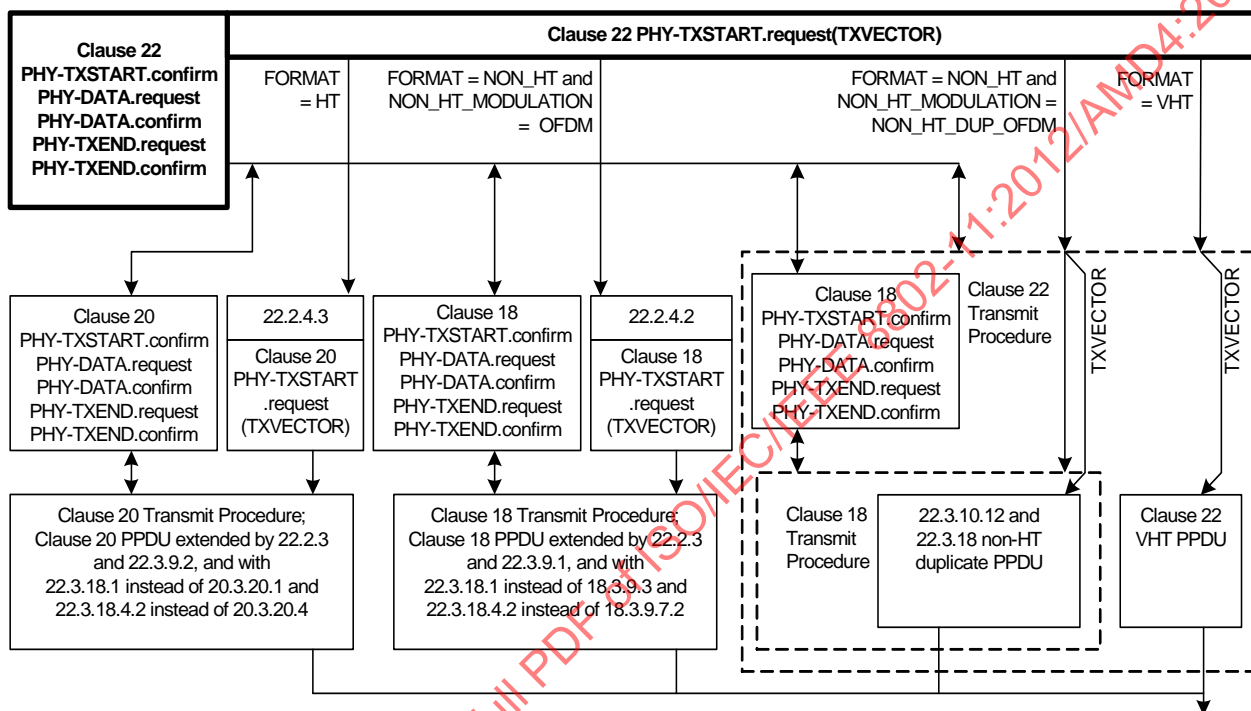
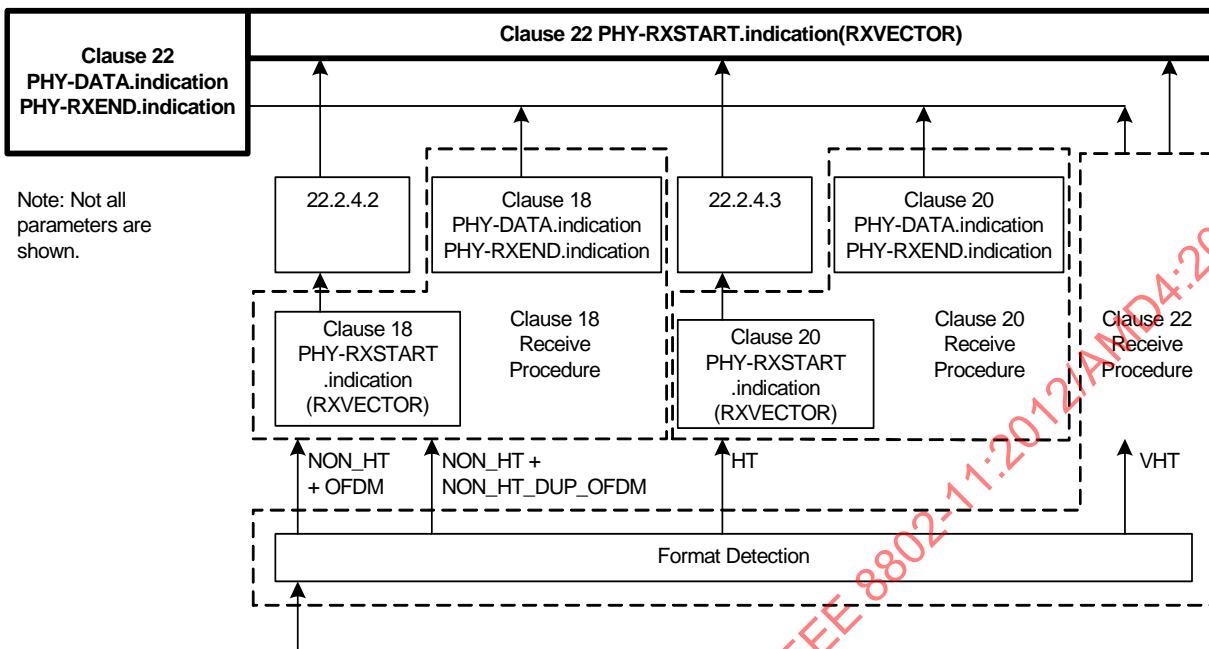

Figure 22-1— PHY interaction on transmit for various PPDU formats



Note: Not all parameters are shown.

Figure 22-2—PHY interaction on receive for various PDU formats

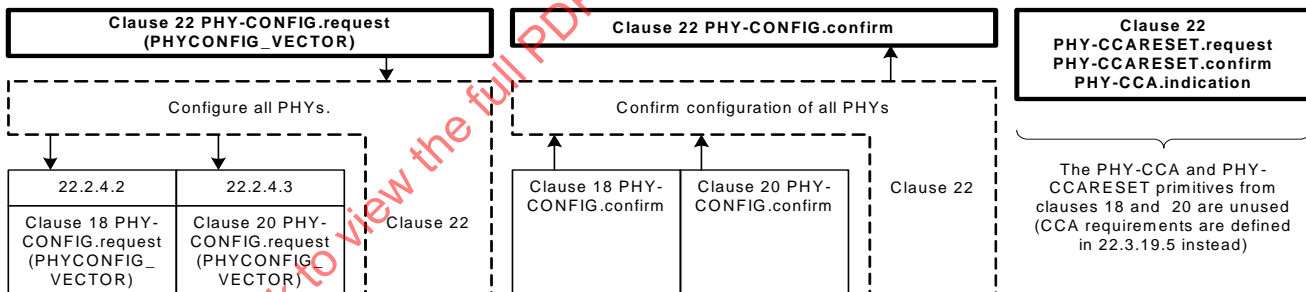

Figure 22-3—PHY-CONFIG and CCA interaction with Clause 18, Clause 20, and Clause 22 PHYs

22.2.4.2 Support for NON_HT format when NON_HT_MODULATION is OFDM

When a PHY-TXSTART.request(TXVECTOR) primitive with the FORMAT parameter equal to NON_HT and the NON_HT_MODULATION parameter equal to OFDM is issued, the behavior of the VHT PHY is defined in Clause 18 with additional requirements described in the following subclauses:

- 22.3.9.1
- 22.3.18.1 instead of 18.3.9.3
- 22.3.18.4.2 instead of 18.3.9.7.2

The Clause 22 TXVECTOR parameters in Table 22-1 are mapped to Clause 18 TXVECTOR parameters in Table 18-1 according to Table 22-3 and the Clause 18 PHY-TXSTART.request(TXVECTOR) primitive is issued.

NOTE—When the FORMAT parameter is set to NON_HT and the NON_HT_MODULATION parameter is set to NON_HT_DUP_OFDM in a PHY-TXSTART.request(TXVECTOR) primitive, the behavior of the VHT PHY is defined in Clause 22.

When the VHT PHY receives a Clause 22 PHYCONFIG.request(PHYCONFIG_VECTOR) primitive, the VHT PHY shall issue a Clause 18 PHYCONFIG.request(PHYCONFIG_VECTOR) primitive but with the OPERATING_CHANNEL and CHANNEL_OFFSET parameters discarded from PHYCONFIG_VECTOR. In order to transmit a non-HT PPDU on the primary channel, the MAC shall configure dot11CurrentFrequency to dot11CurrentPrimaryChannel before transmission.

As defined in 22.3.21, once a PPDU is received and detected as a NON_HT PPDU, the behavior of the VHT PHY is defined in Clause 18. The RXVECTOR parameters from the Clause 18 PHY-RXSTART.indication primitive are mapped to the Clause 22 RXVECTOR parameters as defined in Table 22-3. VHT PHY parameters not listed in the table are not present.

Table 22-3—Mapping of the VHT PHY parameters for NON_HT operation

VHT PHY Parameter	5 GHz operation defined by Clause 18	Parameter List
L_LENGTH	LENGTH	TXVECTOR/RXVECTOR
L_DATARATE	DATARATE	TXVECTOR/RXVECTOR
TXPWR_LEVEL	TXPWR_LEVEL	TXVECTOR
RSSI	RSSI	RXVECTOR
SERVICE	SERVICE	TXVECTOR/RXVECTOR
RCPI	RCPI	RXVECTOR
CH_BANDWIDTH_IN_NON_HT	CH_BANDWIDTH_IN_NON_HT	TXVECTOR/RXVECTOR
DYN_BANDWIDTH_IN_NON_HT	DYN_BANDWIDTH_IN_NON_HT	TXVECTOR/RXVECTOR
OPERATING_CHANNEL	discarded (see NOTE)	PHYCONFIG_VECTOR
CHANNEL_OFFSET	discarded (see NOTE)	PHYCONFIG_VECTOR
NOTE— f_c in Equation (18-1) is set from dot11CurrentFrequency.		

22.2.4.3 Support for HT formats

When a PHY-TXSTART.request(TXVECTOR) primitive with the TXVECTOR parameter FORMAT in a PHY-TXSTART.request equal to HT_MF or HT_GF, the behavior of the PHY is defined by Clause 20 with additional requirements defined in the following subclauses:

- 22.3.9.2
- 22.3.18.1 instead of 20.3.20.1
- 22.3.18.4.2 instead of 20.3.20.4

The Clause 22 TXVECTOR parameters in Table 22-1 are mapped directly to Clause 20 TXVECTOR parameters in Table 20-1 and the Clause 20 PHY-TXSTART.request(TXVECTOR) primitive is issued.

When the VHT PHY receives a Clause 22 PHYCONFIG.request(PHYCONFIG_VECTOR) primitive, the VHT PHY shall issue a Clause 20 PHYCONFIG.request(PHYCONFIG_VECTOR) primitive but with the OPERATING_CHANNEL parameter set to min(40 MHz, dot11CurrentChannelWidth) and the CHANNEL_OFFSET parameter set to CH_OFFSET_NONE if dot11CurrentChannelWidth indicates 20 MHz, to CH_OFFSET_ABOVE if $f_{P20, idx} < f_{S20, idx}$, or to CH_OFFSET_BELOW if $f_{P20, idx} > f_{S20, idx}$. In order to transmit a 40 MHz HT PPDU, the MAC shall configure dot11CurrentSecondaryChannel to $f_{S20, idx}$. The quantities $f_{P20, idx}$ and $f_{S20, idx}$ are defined in 22.3.7.3.

As defined in 22.3.21, once a PPDU is received and detected as an HT PPDU, the behavior of the VHT PHY is defined in Clause 20. The RXVECTOR parameters in Table 20-1 from the Clause 20 PHY-RXSTART.indication primitive are mapped directly to the RXVECTOR parameters in Table 22-1 and a Clause 22 PHY-RXSTART.indication primitive is issued.

22.3 VHT PHY layer

22.3.1 Introduction

This subclause provides the procedure by which PSDUs are converted to and from transmissions on the wireless medium.

During transmission, a PSDU (in the SU case) or one or more PSDUs (in the MU case) are processed (i.e., scrambled and coded) and appended to the PHY preamble to create the PPDU. At the receiver, the PHY preamble is processed to aid in the detection, demodulation, and delivery of the PSDU.

22.3.2 VHT PPDU format

A single PPDU format is defined for this PHY: the VHT PPDU format. Figure 22-4 shows the VHT PPDU format.

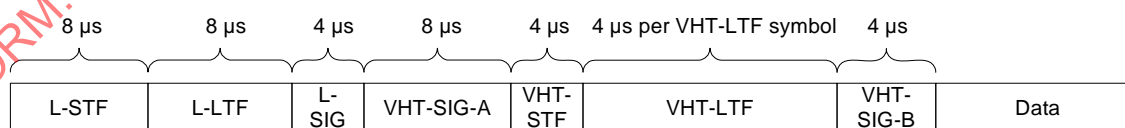

Figure 22-4—VHT PPDU format

The fields of the VHT PPDU format are summarized in Table 22-4.

Table 22-4—Fields of the VHT PPDU

Field	Description
L-STF	Non-HT Short Training field
L-LTF	Non-HT Long Training field
L-SIG	Non-HT SIGNAL field
VHT-SIG-A	VHT Signal A field
VHT-STF	VHT Short Training field
VHT-LTF	VHT Long Training field
VHT-SIG-B	VHT Signal B field
Data	The Data field carries the PSDU(s)

The VHT-SIG-A, VHT-STF, VHT-LTF, and VHT-SIG-B fields exist only in VHT PPDU. In a VHT NDP the Data field is not present. The number of symbols in the VHT-LTF field, N_{VHTLTF} , can be either 1, 2, 4, 6, or 8 and is determined by the total number of space-time streams across all users being transmitted in the VHT PPDU (see Table 22-13).

22.3.3 Transmitter block diagram

The generation of each field in a VHT PPDU uses many of the following blocks:

- a) PHY padding
- b) Scrambler
- c) BCC encoder parser
- d) FEC (BCC or LDPC) encoders
- e) Stream parser
- f) Segment parser (for contiguous 160 MHz and noncontiguous 80+80 MHz transmissions)
- g) BCC interleaver
- h) Constellation mapper
- i) Pilot insertion
- j) Replicate over multiple 20 MHz (if BW > 20 MHz)
- k) Multiply by 1st column of P_{VHTLTF}
- l) LDPC tone mapper
- m) Segment deparser
- n) Space time block code (STBC) encoder
- o) Cyclic shift diversity (CSD) per STS insertion
- p) Spatial mapper
- q) Inverse discrete Fourier transform (IDFT)
- r) Cyclic shift diversity (CSD) per chain insertion
- s) Guard interval (GI) insertion
- t) Windowing

Figure 22-5 to Figure 22-16 show example transmitter block diagrams. The actual structure of the transmitter is implementation dependent. In particular, Figure 22-5 shows the transmit process for the L-SIG and VHT-SIG-A fields of a VHT PPDU using one frequency segment. These transmit blocks are also used to generate the non-VHT modulated fields of the VHT PPDU, except that the BCC encoder and interleaver are not used when generating the L-STF and L-LTF fields.

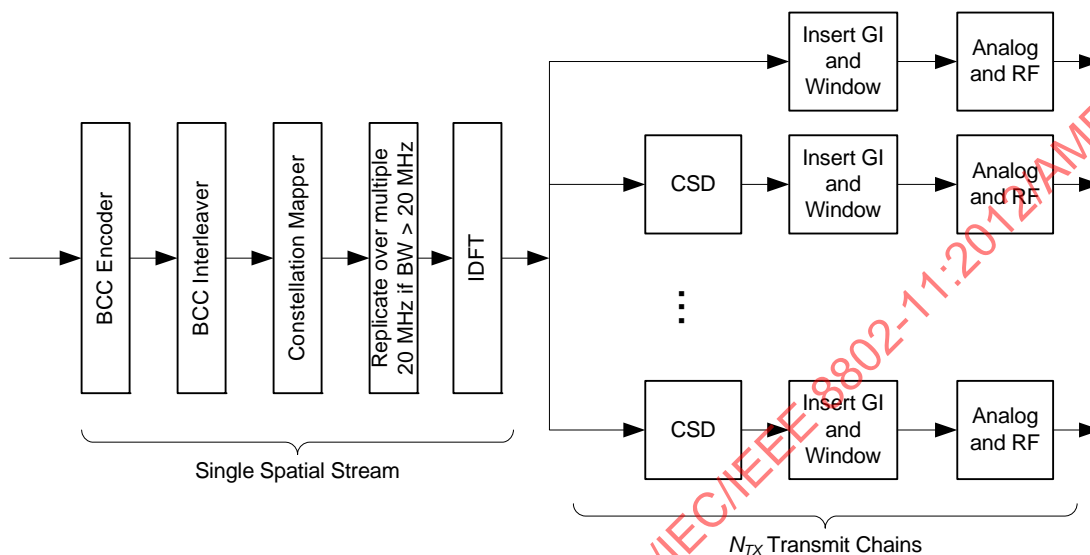

Figure 22-5—Transmitter block diagram for the L-SIG and VHT-SIG-A fields

Figure 22-6 and Figure 22-7 show the transmit process for generating the VHT-SIG-B field of a VHT SU PPDU and VHT MU PPDU, respectively, in 20 MHz, 40 MHz, and 80 MHz channel widths. Figure 22-8 and Figure 22-9 show the transmit process for generating the VHT-SIG-B field of a 160 MHz and 80+80 MHz VHT SU PPDU, respectively.

Figure 22-10 shows the transmitter blocks used to generate the Data field of a 20 MHz, 40 MHz, and 80 MHz VHT SU PPDU with BCC encoding for a single frequency segment. A subset of these transmitter blocks consisting of the constellation mapper and CSD blocks, as well as the blocks to the right of, and including, the spatial mapping block, are also used to generate the VHT-LTF fields. This is illustrated in Figure 22-21. A subset of these transmitter blocks consisting of the constellation mapper and CSD blocks, as well as the blocks to the right of, and including, the spatial mapping block, are also used to generate the VHT-STF field but without the multiplication by A_{VHTLTF}^k (defined in Equation (22-40)).

Figure 22-11 shows the transmitter blocks used to generate the Data field of a 20 MHz, 40 MHz, and 80 MHz VHT SU PPDU with LDPC encoding for a single frequency segment.

Figure 22-12 shows the transmit process for generating the Data field of a 20 MHz, 40 MHz, or 80 MHz VHT MU PPDU with BCC and LDPC encoding.

Figure 22-13 and Figure 22-14 show the transmit process for generating the Data field of a contiguous 160 MHz VHT SU PPDU with BCC and LDPC encoding, respectively.

Figure 22-15 and Figure 22-16 show the transmit process for generating the Data field of a noncontiguous 80+80 MHz VHT SU PPDU with BCC and LDPC encoding, respectively.

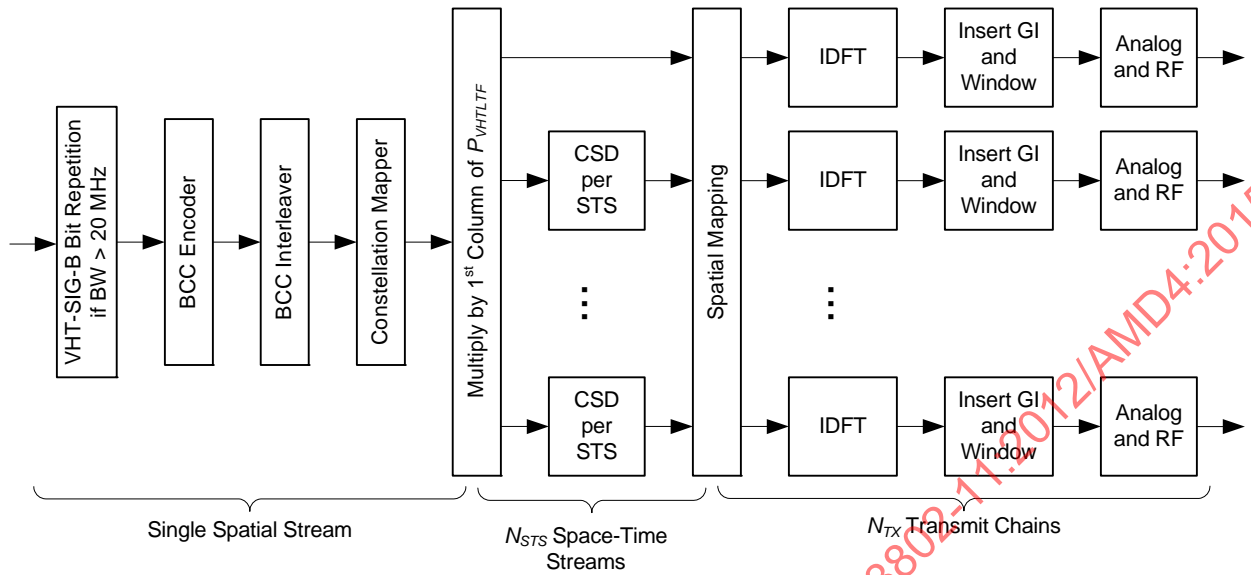

Figure 22-6—Transmitter block diagram for the VHT-SIG-B field of a 20 MHz, 40 MHz, and 80 MHz VHT SU PPDU

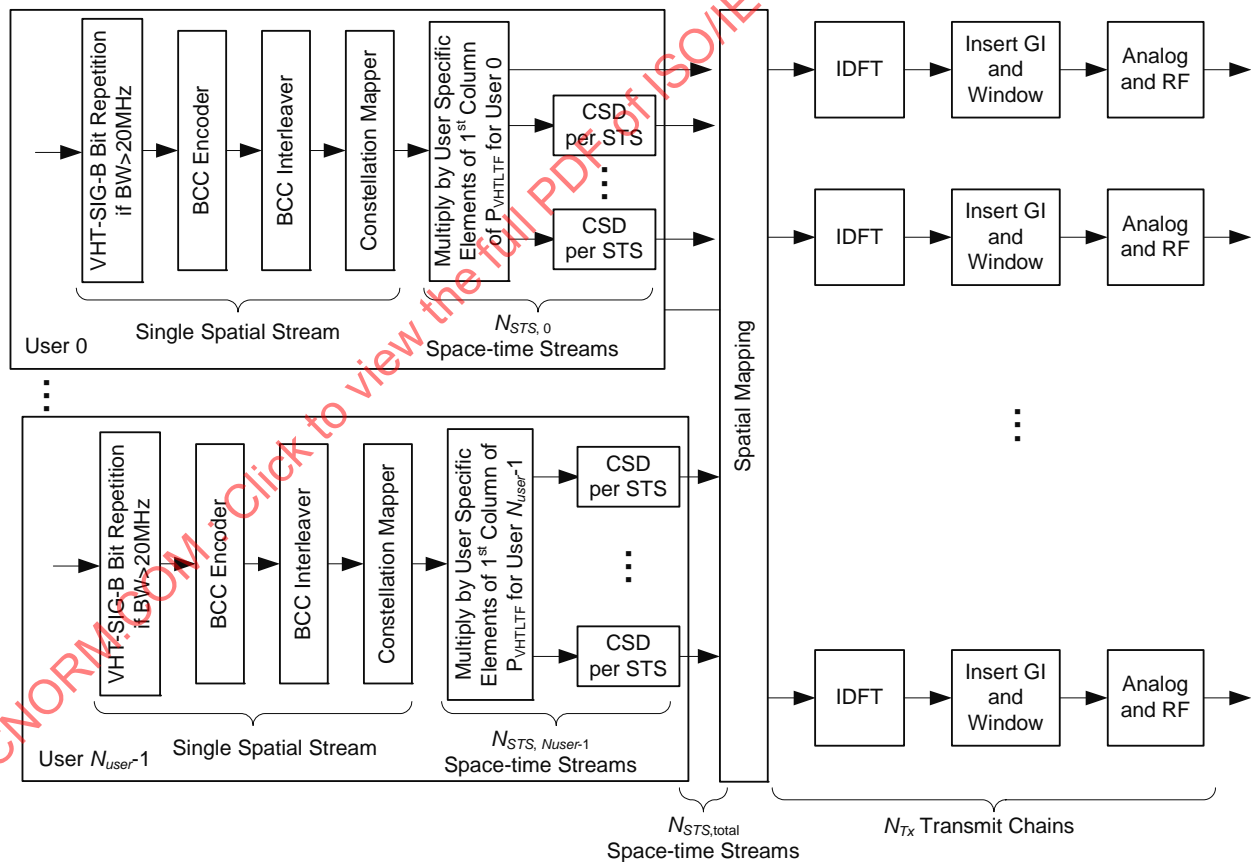

Figure 22-7—Transmitter block diagram for the VHT-SIG-B field of a 20 MHz, 40 MHz, and 80 MHz VHT MU PPDU

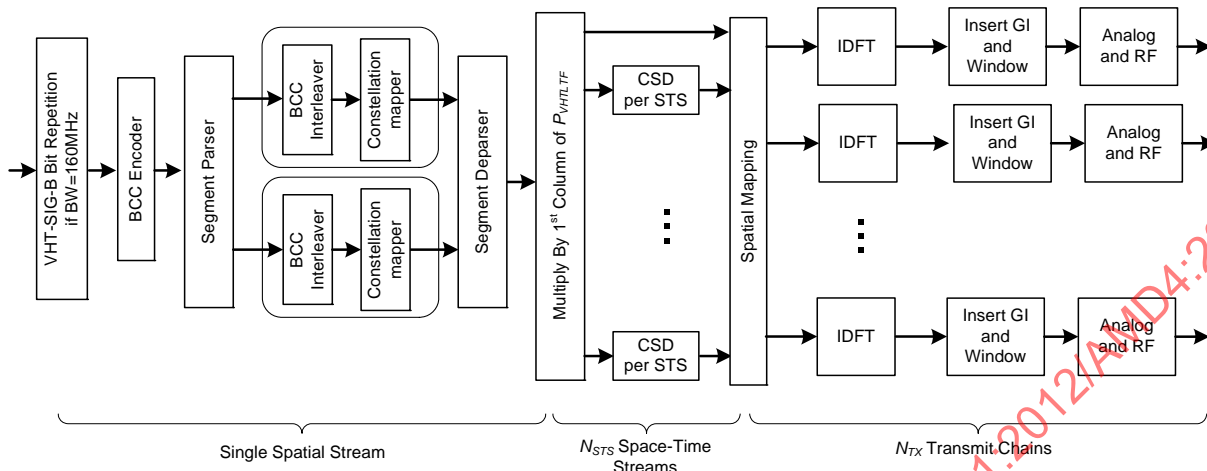

Figure 22-8—Transmitter block diagram for the VHT-SIG-B field of a 160 MHz VHT SU PPDU

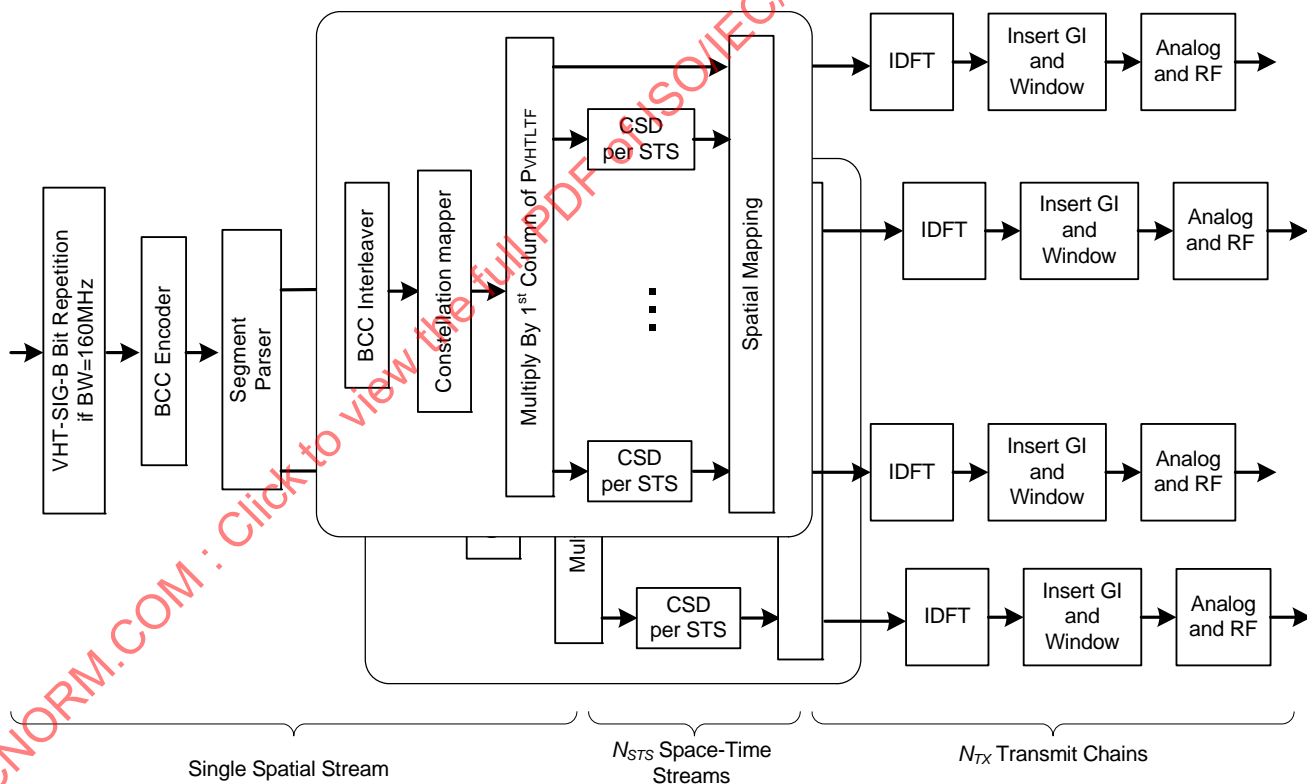

Figure 22-9—Transmitter block diagram for the VHT-SIG-B field of an 80+80 MHz VHT SU PPDU

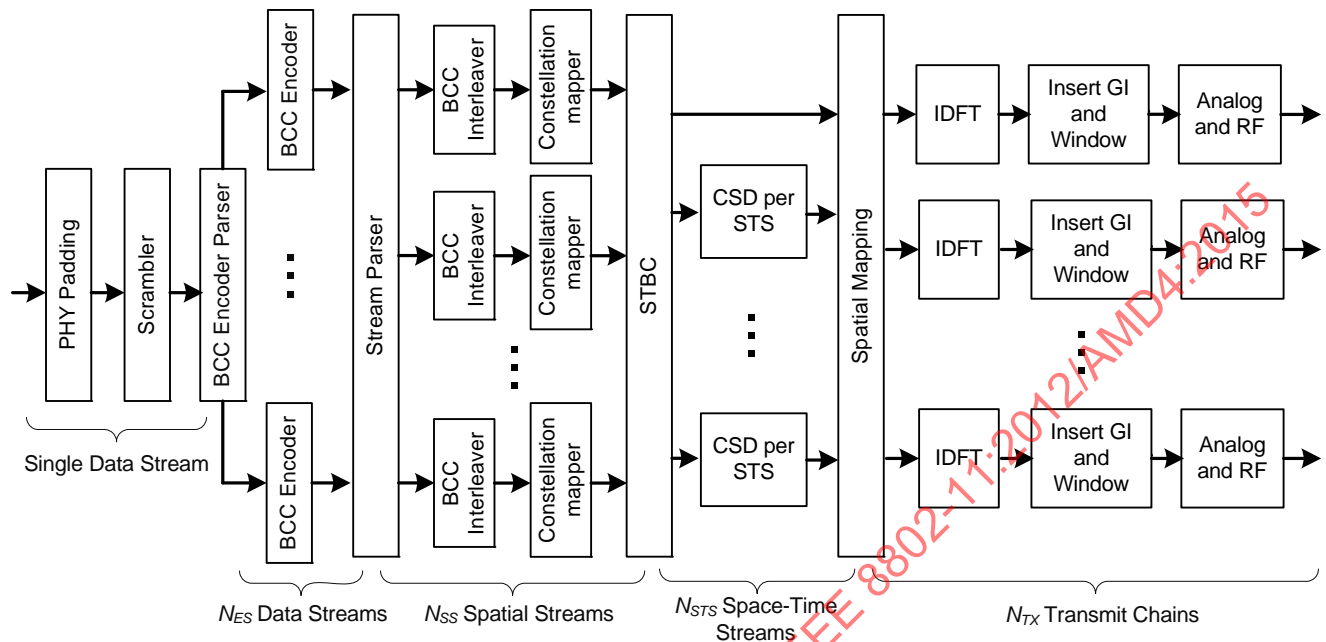

Figure 22-10—Transmitter block diagram for the Data field of a 20 MHz, 40 MHz, or 80 MHz VHT SU PPDU with BCC encoding

22.3.4 Overview of the PPDU encoding process

22.3.4.1 General

This subclause provides an overview of the VHT PPDU encoding process.

22.3.4.2 Construction of L-STF

Construct the L-STF field as defined in 22.3.8.2.2 with the following highlights:

- Determine the CH_BANDWIDTH from the TXVECTOR.
- Sequence generation: Generate the L-STF sequence over the CH_BANDWIDTH as described in 22.3.8.2.2.
- Phase rotation: Apply appropriate phase rotation for each 20 MHz subchannel as described in 22.3.7.4 and 22.3.7.5.
- IDFT: Compute the inverse discrete Fourier transform.
- CSD: Apply CSD for each transmit chain and frequency segment as described in 22.3.8.2.1.
- Insert GI and apply windowing: Prepend a GI (LONG_GI) and apply windowing as described in 22.3.7.4.
- Analog and RF: Up-convert the resulting complex baseband waveform associated with each transmit chain to an RF signal according to the center frequency of the desired channel and transmit. Refer to 22.3.7.4 and 22.3.8 for details.

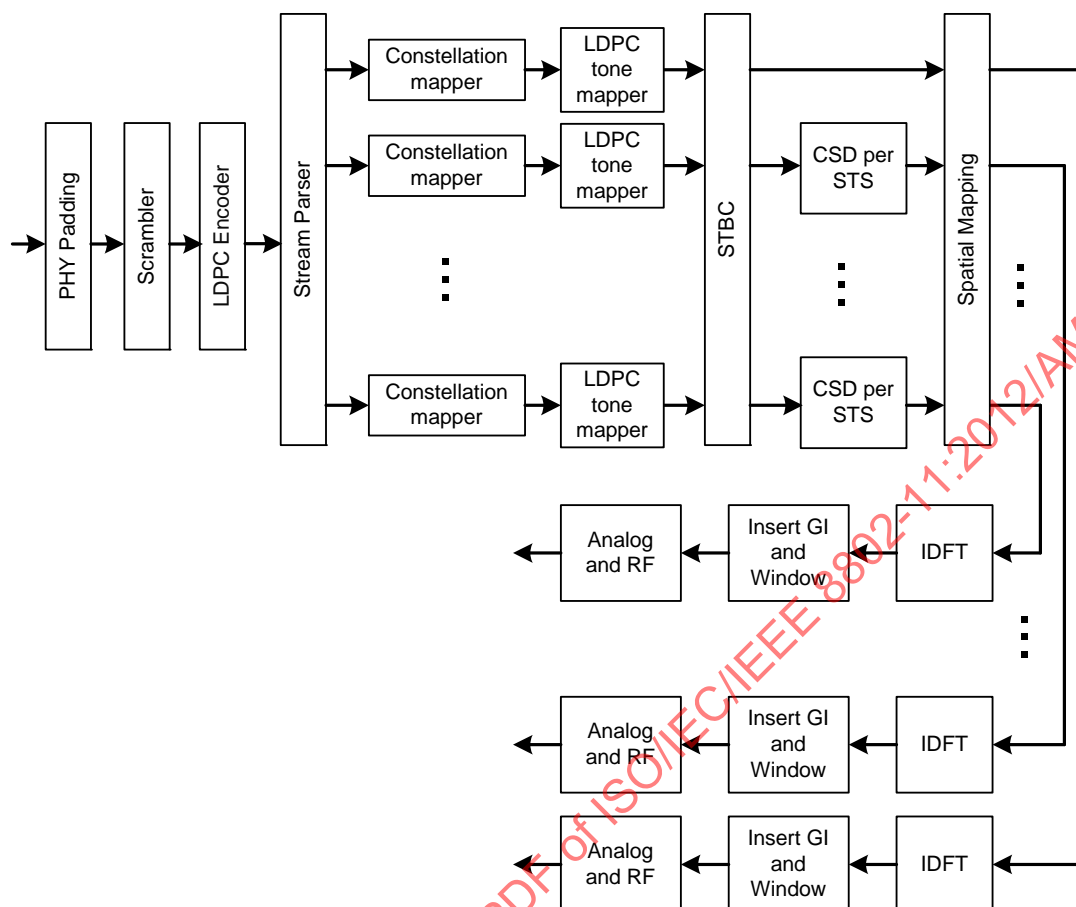

Figure 22-11—Transmitter block diagram for the Data field of a 20 MHz, 40 MHz, or 80 MHz VHT SU PPDU with LDPC encoding

22.3.4.3 Construction of the L-LTF

Construct the L-LTF field as defined in 22.3.8.2.3 with the following highlights:

- Determine the CH_BANDWIDTH from the TXVECTOR.
- Sequence generation: Generate the L-LTF sequence over the CH_BANDWIDTH as described in 22.3.8.2.3.
- Phase rotation: Apply appropriate phase rotation for each 20 MHz subchannel as described in 22.3.7.4 and 22.3.7.5.
- IDFT: Compute the inverse discrete Fourier transform.
- CSD: Apply CSD for each transmit chain and frequency segment as described in 22.3.8.2.1.
- Insert GI and apply windowing: Prepend a GI ($2 \times \text{LONG_GI}$) and apply windowing as described in 22.3.7.4.
- Analog and RF: Up-convert the resulting complex baseband waveform associated with each transmit chain to an RF signal according to the center frequency of the desired channel and transmit. Refer to 22.3.7.4 and 22.3.8 for details.

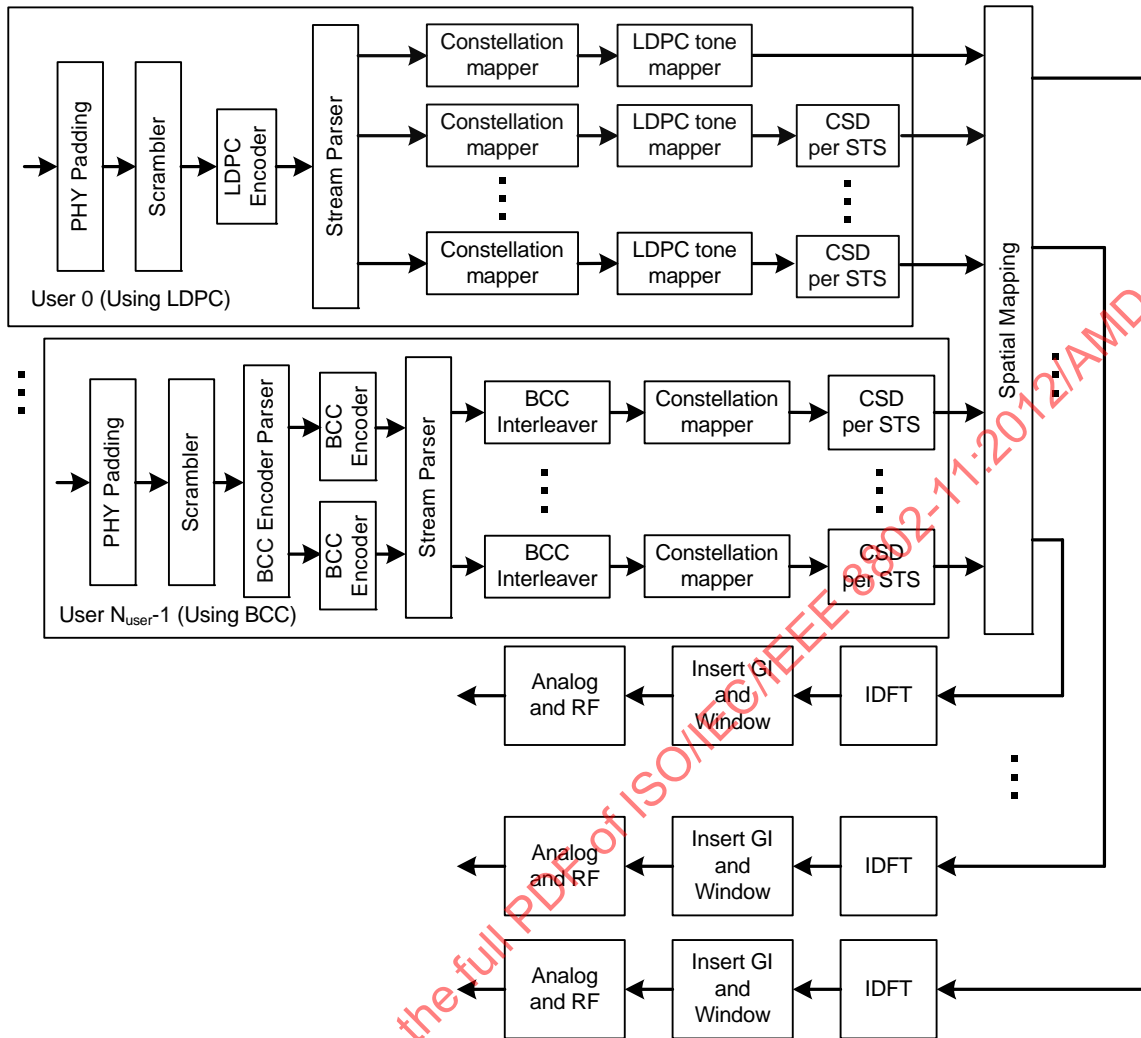

Figure 22-12—Transmitter block diagram for the Data field of a 20 MHz, 40 MHz, or 80 MHz VHT MU PPDU

22.3.4.4 Construction of L-SIG

Construct the L-SIG field as the SIGNAL field defined by 22.3.8.2.4 with the following highlights:

- For a VHT PPDU, set the RATE subfield in the SIGNAL field to 6 Mb/s. Set the Length, Parity, and Tail bits in the SIGNAL field as described in 22.3.8.2.4.
- BCC encoder: Encode the SIGNAL field by a convolutional encoder at the rate of $R=1/2$ as described in 22.3.10.5.3.
- BCC interleaver: Interleave as described in 22.3.10.8.
- Constellation Mapper: BPSK modulate as described in 22.3.10.9.
- Pilot insertion: Insert pilots as described in 22.3.10.11.
- Duplication and phase rotation: Duplicate the L-SIG field over each 20 MHz of the $CH_BANDWIDTH$. Apply appropriate phase rotation for each 20 MHz subchannel as described in 22.3.7.4 and 22.3.7.5.

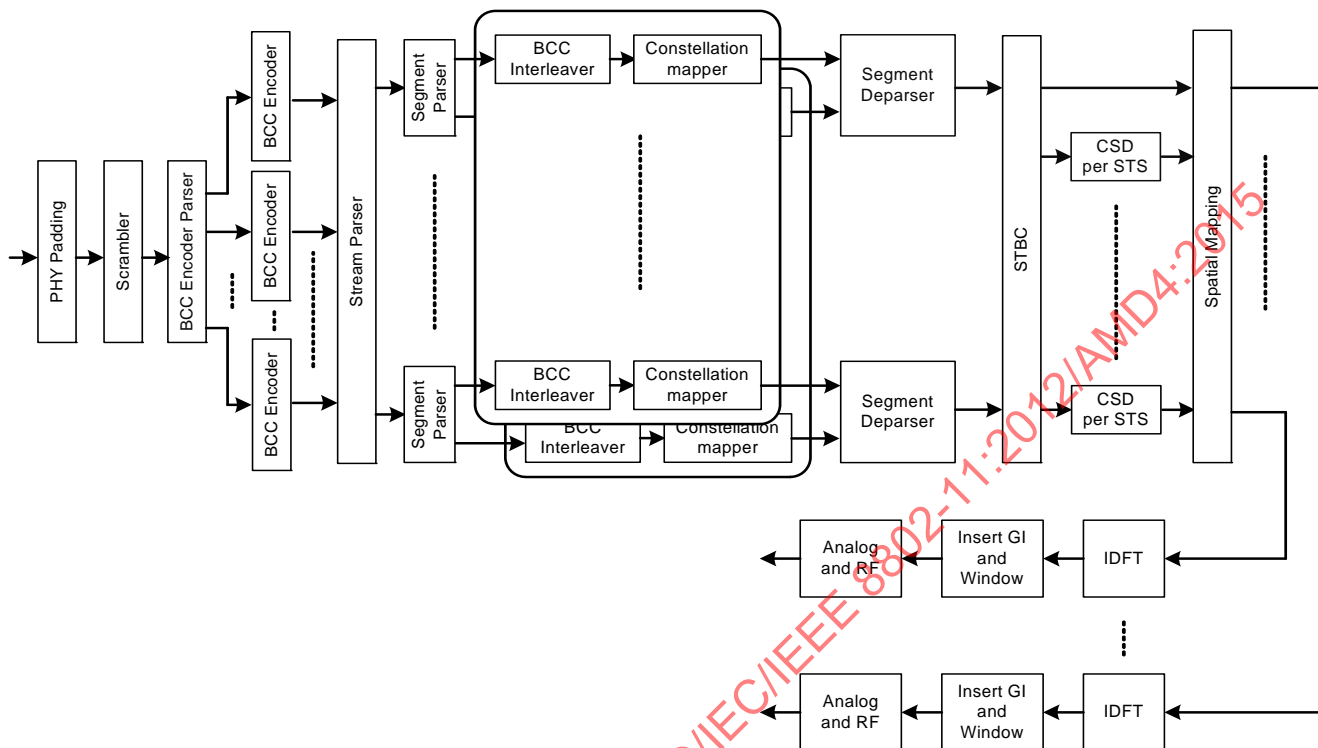

Figure 22-13—Transmitter block diagram for the Data field of a 160 MHz VHT SU PPDU with BCC encoding

- g) IDFT: Compute the inverse discrete Fourier transform.
- h) CSD: Apply CSD for each transmit chain and frequency segment as described in 22.3.8.2.1.
- i) Insert GI and apply windowing: Prepend a GI (LONG_GI) and apply windowing as described in 22.3.7.4.
- j) Analog and RF: Up-convert the resulting complex baseband waveform associated with each transmit chain to an RF signal according to the center frequency of the desired channel and transmit. Refer to 22.3.7.4 and 22.3.8 for details.

22.3.4.5 Construction of VHT-SIG-A

The VHT-SIG-A field consists of two symbols, VHT-SIG-A1 and VHT-SIG-A2, as defined in 22.3.8.3.3 and is constructed as follows:

- a) Obtain the CH_BANDWIDTH, STBC, GROUP_ID, PARTIAL_AID (SU only), NUM_STS, GI_TYPE, FEC_CODING, MCS (SU only), BEAMFORMED (SU only), NUM_USERS, and TXOP_PS_NOT_ALLOWED from the TXVECTOR. Add the reserved bits, append the calculated CRC, then append the N_{tail} tail bits as shown in 22.3.8.3.3. This results in 48 uncoded bits.
- b) BCC encoder: Encode the data by a convolutional encoder at the rate of $R=1/2$ as described in 18.3.5.6
- c) BCC interleaver: Interleave as described in 18.3.5.7.
- d) Constellation mapper: BPSK modulate the first 48 interleaved bits as described in 18.3.5.8 to form the first symbol of VHT-SIG-A. BPSK modulate the second 48 interleaved bits and rotate by 90° counter-clockwise relative to the first symbol to form the second symbol of VHT-SIG-A.

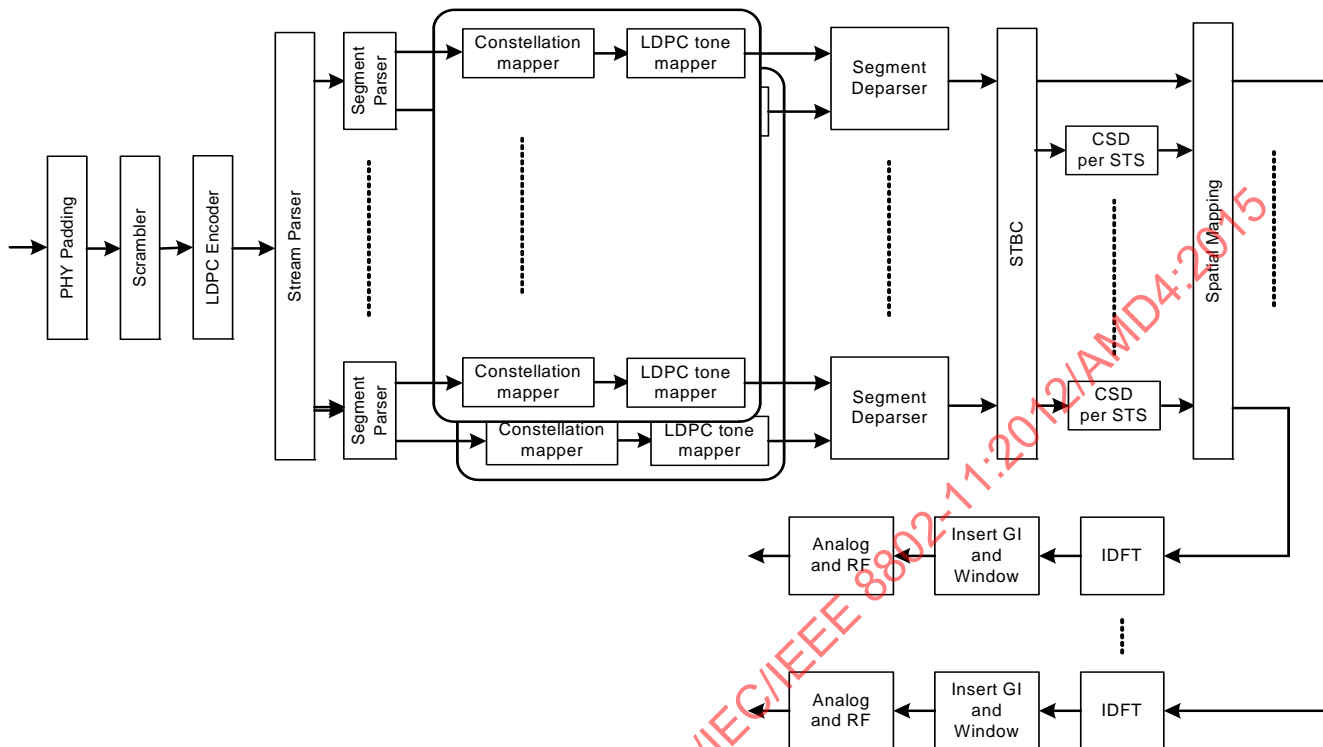

Figure 22-14—Transmitter block diagram for the Data field of a 160 MHz VHT SU PPDU with LDPC encoding

- e) Pilot insertion: Insert pilots as described in 18.3.5.10.
- f) Duplication and phase rotation: Duplicate VHT-SIG-A1 and VHT-SIG-A2 over each 20 MHz of the CH_BANDWIDTH. Apply the appropriate phase rotation for each 20 MHz subchannel as described in 22.3.7.4 and 22.3.7.5.
- g) IDFT: Compute the inverse discrete Fourier transform.
- h) CSD: Apply CSD for each transmit chain as described in 22.3.8.2.1.
- i) Insert GI and apply windowing: Prepend a GI (LONG_GI) and apply windowing as described in 22.3.7.4.
- j) Analog and RF: Up-convert the resulting complex baseband waveform associated with each transmit chain to an RF signal according to the center frequency of the desired channel and transmit. Refer to 22.3.7.4 and 22.3.8 for details.

22.3.4.6 Construction of VHT-STF

The VHT-STF field is defined in 22.3.8.3.4 and is constructed as follows:

- a) Sequence generation: Generate the VHT-STF in the frequency-domain over the bandwidth indicated by CH_BANDWIDTH as described in 22.3.8.3.4.
- b) Phase rotation: Apply appropriate phase rotation for each 20 MHz subchannel as described in 22.3.7.4 and 22.3.7.5.
- c) CSD: Apply CSD for each space-time stream and frequency segment as described in 22.3.8.3.2.
- d) Spatial mapping: Apply the Q matrix as described in 22.3.10.11.1.

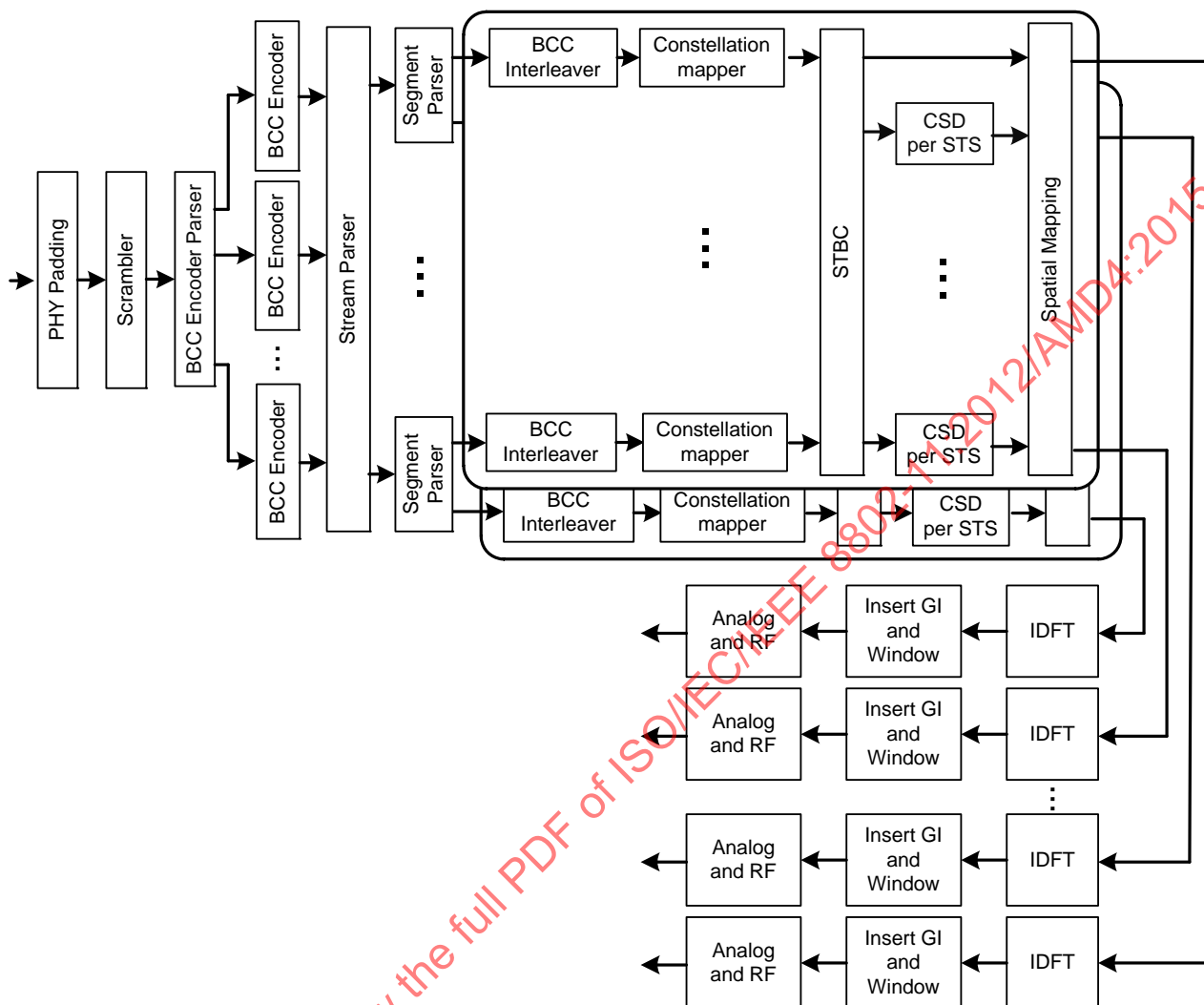

Figure 22-15—Transmitter block diagram for the Data field of an 80+80 MHz VHT SU PPDU with BCC encoding

- e) IDFT: Compute the inverse discrete Fourier transform.
- f) Insert GI and apply windowing: Prepend a GI (LONG_GI) and apply windowing as described in 22.3.7.4.
- g) Analog and RF: Up-convert the resulting complex baseband waveform associated with each transmit chain to an RF signal according to the center frequency of the desired channel and transmit. Refer to 22.3.7.4 and 22.3.8 for details.

22.3.4.7 Construction of VHT-LTF

The VHT-LTF field is defined in 22.3.8.3.5 and constructed as follows:

- a) Sequence generation: Generate the VHT-LTF sequence in the frequency-domain over the bandwidth indicated by CH_BANDWIDTH as described in 22.3.8.3.5.

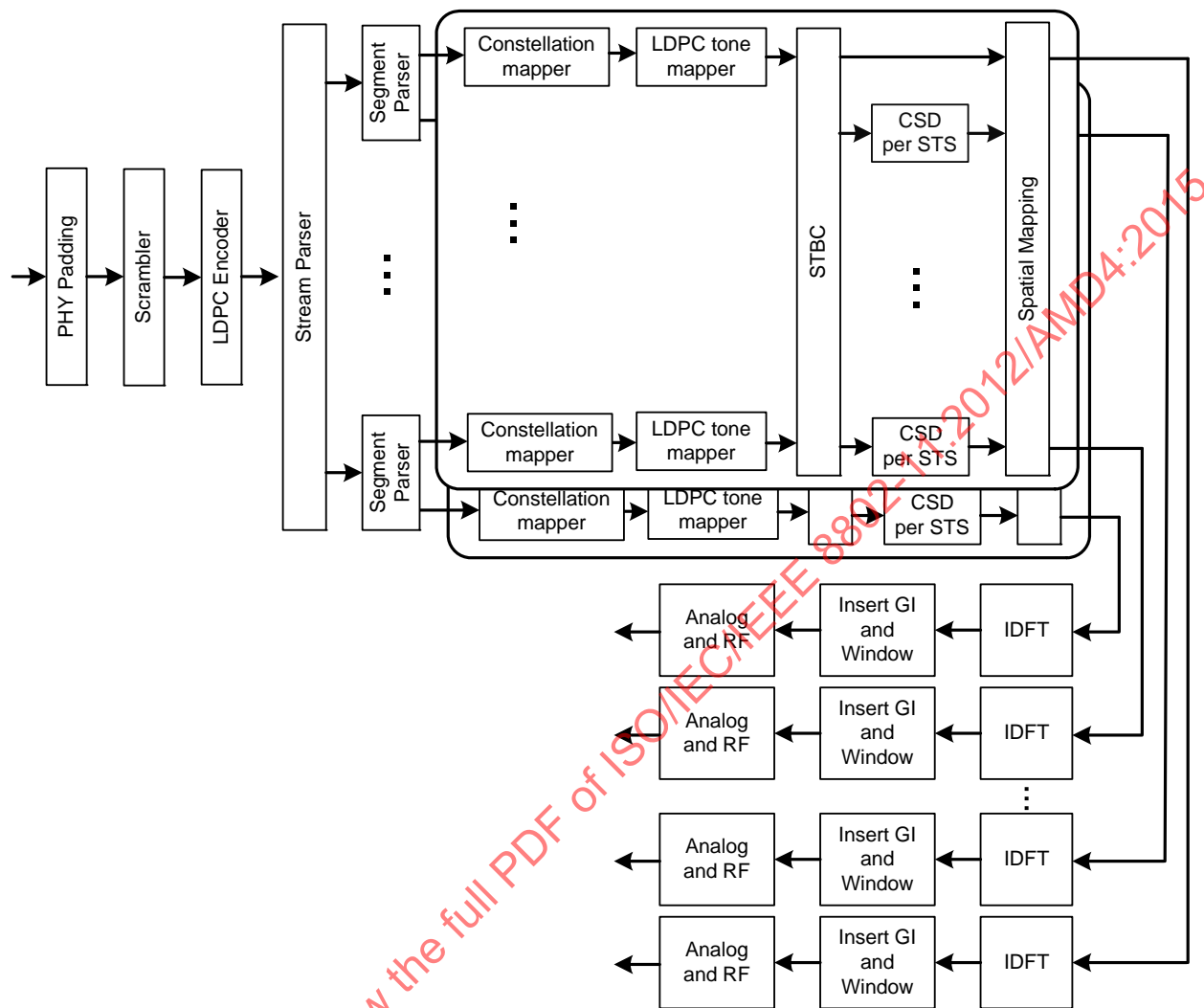

Figure 22-16—Transmitter block diagram for the Data field of an 80+80 MHz VHT SU PPDU with LDPC encoding

- b) Phase rotation: Apply appropriate phase rotation for each 20 MHz subchannel as described in 22.3.7.4 and 22.3.7.5.
- c) A_{VHLLTF} matrix mapping: Apply the P_{VHLLTF} matrix to the VHT-LTF sequence and apply the R_{VHLLTF} matrix to the pilot tones as described in 22.3.8.3.5.
- d) CSD: Apply CSD for each space-time stream and frequency segment as described in 22.3.8.3.2.
- e) Spatial mapping: Apply the Q matrix as described in 22.3.10.11.1.
- f) IDFT: Compute the inverse discrete Fourier transform.
- g) Insert GI and apply windowing: Prepend a GI (LONG_GI) and apply windowing as described in 22.3.7.4.
- h) Analog and RF: Up-convert the resulting complex baseband waveform associated with each transmit chain to an RF signal according to the center frequency of the desired channel and transmit. Refer to 22.3.7.4 and 22.3.8 for details.

22.3.4.8 Construction of VHT-SIG-B

The VHT-SIG-B field is constructed per-user as follows:

- a) Obtain the VHT-MCS (for MU only) and APEP_LENGTH from the TXVECTOR.
- b) VHT-SIG-B bits: Set the VHT-MCS (for MU only) and VHT-SIG-B Length field as described in 22.3.8.3.6. Add the reserved bits (for SU only) and N_{tail} bits of tail. For an NDP set VHT-SIG-B to the fixed bit pattern for the bandwidth used as described in 22.3.8.3.6.
- c) VHT-SIG-B Bit Repetition: Repeat the VHT-SIG-B bits as a function of CH_BANDWIDTH as defined in 22.3.8.3.6.
- d) BCC encoder: Encode the VHT-SIG-B field using BCC at rate $R=1/2$ as described in 18.3.5.6.
- e) Segment parser (if needed): For a contiguous 160 MHz or noncontiguous 80+80 MHz transmission, divide the output bits of the BCC encoder into two frequency subblocks as described in 22.3.10.7. This block is bypassed for 20 MHz, 40 MHz, and 80 MHz VHT PPDU transmissions.
- f) BCC interleaver: Interleave as described in 22.3.10.8.
- g) Constellation mapper: Map to a BPSK constellation as defined in 18.3.5.8.
- h) Segment deparser (if needed): For a contiguous 160 MHz transmission, merge the two frequency subblocks into one frequency segment as described in 22.3.10.9.3. This block is bypassed for 20 MHz, 40 MHz, 80 MHz, and 80+80 MHz VHT PPDU transmissions.
- i) Pilot insertion: Insert pilots following the steps described in 22.3.10.10.
- j) P_{VHTLTF} matrix mapping: Apply the mapping of the 1st column of the P_{VHTLTF} matrix to the data subcarriers as described in 22.3.8.3.6. The total number of data and pilot subcarriers is the same as in the Data field.
- k) CSD: Apply CSD for each space-time stream and frequency segment as described in 22.3.8.3.2.
- l) Spatial mapping: Apply the Q matrix as described in 22.3.10.11.1.
- m) Phase rotation: Apply the appropriate phase rotations for each 20 MHz subchannel as described in 22.3.7.4 and 22.3.7.5.
- n) IDFT: Compute the inverse discrete Fourier transform.
- o) Insert GI and apply windowing: Prepend a GI (LONG_GI) and apply windowing as described in 22.3.7.4.
- p) Analog and RF: Up-convert the resulting complex baseband waveform associated with each transmit chain to an RF signal according to the center frequency of the desired channel and transmit. Refer to 22.3.7.4 and 22.3.8 for details.

22.3.4.9 Construction of the Data field in a VHT SU PPDU

22.3.4.9.1 Using BCC

The construction of the Data field in a VHT SU PPDU with BCC encoding proceeds as follows:

- a) Insert the CRC calculated for VHT-SIG-B in the SERVICE field as described in 22.3.10.2 and append the PSDU to the SERVICE field.
- b) PHY padding: Append the PHY pad bits and tail bits to the PSDU.
- c) Scrambler: Scramble the PHY padded data.
- d) BCC encoder: Divide the scrambled bits between the encoders by sending bits to different encoders in a round robin manner. The number of encoders is determined by rate-dependent parameters described in 22.5. BCC encode as described in 22.3.10.5.2 and 22.3.10.5.3.
- e) Stream parser: Rearrange the output of the BCC encoders into blocks as described in 22.3.10.6.

- f) Segment parser (if needed): For a contiguous 160 MHz or noncontiguous 80+80 MHz transmission, divide the output bits of each stream parser into two frequency subblocks as described in 22.3.10.7. This block is bypassed for 20 MHz, 40 MHz, and 80 MHz VHT PPDU transmissions.
- g) BCC interleaver: Interleave as described in 22.3.10.8.
- h) Constellation mapper: Map to BPSK, QPSK, 16-QAM, 64-QAM, or 256-QAM constellation points as described in 22.3.10.9.
- i) Segment deparser (if needed): For a contiguous 160 MHz transmission, merge the two frequency subblocks into one frequency segment as described in 22.3.10.9.3. This block is bypassed for 20 MHz, 40 MHz, 80 MHz, and 80+80 MHz VHT PPDU transmissions.
- j) STBC: Apply STBC as described in 22.3.10.9.4.
- k) Pilot insertion: Insert pilots following the steps described in 22.3.10.10.
- l) CSD: Apply CSD for each space-time stream and frequency segment as described in 22.3.8.3.2.
- m) Spatial mapping: Apply the Q matrix as described in 22.3.10.11.1.
- n) Phase rotation: Apply the appropriate phase rotations for each 20 MHz subchannel as described in 22.3.7.4 and 22.3.7.5.
- o) IDFT: For a noncontiguous 80+80 MHz transmission, map each frequency subblocks to the separate IDFT. Compute the inverse discrete Fourier transform.
- p) Insert GI and apply windowing: Prepend a GI (SHORT_GI or LONG_GI) and apply windowing as described in 22.3.7.4.
- q) Analog and RF: Up-convert the resulting complex baseband waveform associated with each transmit chain to an RF signal according to the center frequency of the desired channel and transmit. Refer to 22.3.7.4 and 22.3.8 for details.

22.3.4.9.2 Using LDPC

The construction of the Data field in a VHT SU PPDU with LDPC encoding proceeds as follows:

- a) Insert the CRC calculated for VHT-SIG-B in the SERVICE field as described in 22.3.10.2 and append the PSDU to the SERVICE field.
- b) PHY padding: Append the PHY pad bits to the PSDU. There are no tail bits.
- c) Scrambler: Scramble the PHY padded data.
- d) LDPC encoder: The scrambled bits are encoded using the LDPC code with the APEP_LENGTH in the TXVECTOR as described in 22.3.10.5.4.
- e) Stream parser: The output of the LDPC encoder is rearranged into blocks as described in 22.3.10.6.
- f) Segment parser (if needed): For a contiguous 160 MHz or noncontiguous 80+80 MHz transmission, divide the output bits of each stream parser into two frequency subblocks as described in 22.3.10.7. This block is bypassed for 20 MHz, 40 MHz, and 80 MHz VHT PPDU transmissions.
- g) Constellation mapper: Map to BPSK, QPSK, 16-QAM, 64-QAM or 256-QAM constellation points as described in 22.3.10.9.
- h) LDPC tone mapper: The LDPC tone mapping shall be performed on all LDPC encoded streams as described in 22.3.10.9.2.
- i) Segment deparser (if needed): For a contiguous 160 MHz transmission, merge the two frequency subblocks into one frequency segment as described in 22.3.10.9.3. This block is bypassed for 20 MHz, 40 MHz, 80 MHz, and 80+80 MHz VHT PPDU transmissions.
- j) STBC: Apply STBC as described in 22.3.10.9.4.
- k) Pilot insertion: Insert pilots following the steps described in 22.3.10.10.
- l) CSD: Apply CSD for each space-time stream and frequency segment as described in 22.3.8.3.2.
- m) Spatial mapping: Apply the Q matrix as described in 22.3.10.11.1.

- n) Phase rotation: Apply the appropriate phase rotations for each 20 MHz subchannel as described in 22.3.7.4 and 22.3.7.5.
- o) IDFT: For a noncontiguous 80+80 MHz transmission, map each frequency subblocks to the separate IDFT. Compute the inverse discrete Fourier transform.
- p) Insert GI and apply windowing: Prepend a GI (SHORT_GI or LONG_GI) and apply windowing as described in 22.3.7.4.
- q) Analog and RF: Up-convert the resulting complex baseband waveform associated with each transmit chain to an RF signal according to the center frequency of the desired channel and transmit. Refer to 22.3.7.4 and 22.3.8 for details.

22.3.4.10 Construction of the Data field in a VHT MU PPDU

22.3.4.10.1 General

For an MU transmission, the PPDU encoding process is performed on a per-user basis up to the input of the Spatial Mapping block except CSD (as described in 22.3.8.3.2). All user data is combined and mapped to the transmit chains in the Spatial Mapping block.

22.3.4.10.2 Using BCC

A Data field with BCC encoding is constructed using the process described in 22.3.4.9.1 before the spatial mapping block and repeated for each user that uses BCC encoding.

22.3.4.10.3 Using LDPC

A Data field with LDPC encoding is constructed using the process described in 22.3.4.9.2 before the spatial mapping block and repeated for each user that uses LDPC encoding.

22.3.4.10.4 Combining to form a VHT MU PPDU

The per-user data is combined as follows:

- a) Spatial Mapping: The Q matrix is applied as described in 22.3.10.11.1. The combining of all user data is done in this block.
- b) Phase rotation: Apply the appropriate phase rotations for each 20 MHz subchannel as described in 22.3.7.4 and 22.3.7.5.
- c) IDFT: Compute the inverse discrete Fourier transform.
- d) Insert GI and apply windowing: Prepend a GI (SHORT_GI or LONG_GI) and apply windowing as described in 22.3.7.4.
- e) Analog and RF: Up-convert the resulting complex baseband waveform associated with each transmit chain to an RF signal according to the center frequency of the desired channel and transmit. Refer to 22.3.7.4 and 22.3.8 for details.

22.3.5 VHT modulation and coding scheme (VHT-MCS)

The VHT-MCS is a value that determines the modulation and coding used in the Data field of the PPDU. It is a compact representation that is carried in the VHT-SIG-A field for VHT SU PPDUs and in the VHT-SIG-B field for VHT MU PPDUs. Rate-dependent parameters for the full set of VHT-MCSs are shown in Table 22-30 to Table 22-61 (in 22.5). These tables give rate-dependent parameters for VHT-MCSs with indices 0 to 9, with number of spatial streams from 1 to 8 and bandwidth options of 20 MHz, 40 MHz, 80 MHz, and either 160 MHz or 80+80 MHz. Equal modulation (EQM) is applied to all streams for a particular user.

22.3.6 Timing-related parameters

Refer to Table 20-6 for timing-related parameters for non-VHT formats.

Table 22-5 defines the timing-related parameters for VHT format.

Table 22-5—Timing-related constants

Parameter	CBW20	CBW40	CBW80	CBW80+80	CBW160	Description
N_{SD}	52	108	234	234	468	Number of complex data numbers per frequency segment
N_{SP}	4	6	8	8	16	Number of pilot values per frequency segment
N_{ST}	56	114	242	242	484	Total number of subcarriers per frequency segment. See NOTE.
N_{SR}	28	58	122	122	250	Highest data subcarrier index per frequency segment
N_{Seg}	1	1	1	2	1	Number of frequency segments
Δ_F	312.5 kHz					Subcarrier frequency spacing
T_{DFT}	3.2 μ s					IDFT/DFT period
T_{GI}	0.8 μ s = $T_{DFT}/4$					Guard interval duration
T_{GI2}	1.6 μ s					Double guard interval
T_{GIS}	0.4 μ s = $T_{DFT}/8$					Short guard interval duration
T_{SYML}	4 μ s = $T_{DFT} + T_{GI} = 1.25 \times T_{DFT}$					Long GI symbol interval
T_{SYMS}	3.6 μ s = $T_{DFT} + T_{GIS} = 1.125 \times T_{DFT}$					Short GI symbol interval
T_{SYM}	T_{SYML} or T_{SYMS} depending on the GI used (see Table 22-8)					Symbol interval
T_{L-STF}	8 μ s = $10 \times T_{DFT}/4$					Non-HT Short Training field duration
T_{L-LTF}	8 μ s = $2 \times T_{DFT} + T_{GI2}$					Non-HT Long Training field duration
T_{L-SIG}	4 μ s = T_{SYML}					Non-HT SIGNAL field duration
$T_{VHT-SIG-A}$	8 μ s = $2T_{SYML}$					VHT Signal A field duration
$T_{VHT-STF}$	4 μ s = T_{SYML}					VHT Short Training field duration

Table 22-5—Timing-related constants (continued)

Parameter	CBW20	CBW40	CBW80	CBW80+80	CBW160	Description
$T_{VHT-LTF}$	$4 \mu\text{s} = T_{SYML}$					Duration of each VHT-LTF symbol
$T_{VHT-SIG-B}$	$4 \mu\text{s} = T_{SYML}$					VHT Signal B field duration
$N_{service}$	16					Number of bits in the SERVICE field
N_{tail}	6					Number of tail bits per BCC encoder
NOTE— $N_{ST} = N_{SD} + N_{SP}$						

Table 22-6 defines parameters used frequently in Clause 22.

Table 22-6—Frequently used parameters

Symbol	Explanation
$N_{CBPS}, N_{CBPS,u}$	Number of coded bits per symbol for user u , $u = 0, \dots, N_{user}-1$. For a VHT SU PPDU, $N_{CBPS} = N_{CBPS,0}$ For a VHT MU PPDU, N_{CBPS} is undefined
$N_{CBPSS}, N_{CBPSS,u}$	Number of coded bits per symbol per spatial stream. For the VHT-SIG-B field, N_{CBPSS} is common for all users. $N_{CBPSS} = \begin{cases} N_{SD}, & \text{for a 20 MHz, 40 MHz, 80 MHz, and 160 MHz PPDU} \\ 2N_{SD}, & \text{for an 80+80 MHz PPDU} \end{cases}$ for all users. For the Data field, $N_{CBPSS,u}$ equals the number of coded bits per symbol per spatial stream for user u , $u = 0, \dots, N_{user}-1$. For the Data field of a VHT SU PPDU, $N_{CBPSS} = N_{CBPSS,0}$ For the Data field of a VHT MU PPDU, N_{CBPSS} is undefined
$N_{CBPSSI}, N_{CBPSSI,u}$	Number of coded bits per symbol per spatial stream per BCC interleaver block. For a VHT SU PPDU, $N_{CBPSSI} = \begin{cases} N_{CBPSS}, & \text{for a 20 MHz, 40 MHz, or 80 MHz PPDU} \\ \frac{N_{CBPSS}}{2}, & \text{for a 160 MHz or 80+80 MHz PPDU} \end{cases}$ For a VHT MU PPDU for user u , $u = 0, \dots, N_{user}-1$ $N_{CBPSSI,u} = \begin{cases} N_{CBPSS,w}, & \text{for a 20 MHz, 40 MHz, or 80 MHz PPDU} \\ \frac{N_{CBPSS,u}}{2}, & \text{for a 160 MHz or 80+80 MHz PPDU} \end{cases}$ For a VHT MU PPDU, N_{CBPSSI} is undefined.

Table 22-6—Frequently used parameters (continued)

Symbol	Explanation
$N_{DBPS}, N_{DBPS,u}$	Number of data bits per symbol for user u , $u = 0, \dots, N_{user}-1$. For a VHT SU PPDU, $N_{DBPS} = N_{DBPS,0}$ For a VHT MU PPDU, N_{DBPS} is undefined
$N_{BPSCS}, N_{BPSCS,u}$	Number of coded bits per subcarrier per spatial stream for user u , $u = 0, \dots, N_{user}-1$. For a VHT SU PPDU, $N_{BPSCS} = N_{BPSCS,0}$ For a VHT MU PPDU, N_{BPSCS} is undefined
N_{RX}	Number of receive chains
N_{user}	For pre-VHT modulated fields, $N_{user} = 1$. For VHT modulated fields, N_{user} represents the number of users in the transmission (equal to the TXVECTOR parameter NUM_USERS).
$N_{STS}, N_{STS,u}$	For pre-VHT modulated fields, $N_{STS,u} = 1$ (see NOTE 2). For VHT modulated fields, $N_{STS,u}$ is the number of space-time streams for user u , $u = 0, \dots, N_{user}-1$. For a VHT SU PPDU, $N_{STS} = N_{STS,0}$ For a VHT MU PPDU, N_{STS} is undefined.
$N_{STS,total}$	For VHT modulated fields, $N_{STS,total}$ is the total number of space-time streams in a PPDU. $N_{STS,total} = \sum_{u=0}^{N_{user}-1} N_{STS,u}$ For pre-VHT modulated fields, $N_{STS,total}$ is undefined. Note that $N_{STS,total} = N_{STS}$ for a VHT SU PPDU.
$N_{SS}, N_{SS,u}$	Number of spatial streams. For the VHT-SIG-B field, $N_{SS} = 1$ for each user. For the Data field, $N_{SS,u}$ is the number of spatial streams for user u , $u = 0, \dots, N_{user}-1$. For the Data field of a VHT SU PPDU, $N_{SS} = N_{SS,0}$ For the Data field of a VHT MU PPDU, N_{SS} is undefined.
N_{TX}	Number of transmit chains
$N_{ES}, N_{ES,u}$	The number of BCC encoders. For the VHT-SIG-B field, $N_{ES} = 1$ for each user. For a Data field encoded using BCC, $N_{ES,u}$ is the number of BCC encoders for user u , $u = 0, \dots, N_{user}-1$. For the Data field encoded using LDPC, $N_{ES} = 1$ for a VHT SU PPDU and $N_{ES,u} = 1$ for a VHT MU PPDU for user u , $u = 0, \dots, N_{user}-1$. For the Data field of a VHT SU PPDU, $N_{ES} = N_{ES,0}$ For the Data field of a VHT MU PPDU, N_{ES} is undefined.
N_{VHTLTF}	Number of VHT-LTF symbols (see 22.3.8.3.5)
R, R_u	R_u is the coding rate for user u , $u = 0, \dots, N_{user}-1$. For a VHT SU PPDU, $R = R_0$ For a VHT MU PPDU, R is undefined

Table 22-6—Frequently used parameters (continued)

Symbol	Explanation
M_u	For pre-VHT modulated fields, $M_u = 0$. For VHT modulated fields, $M_0 = 0$ for $u = 0$ and $M_u = \sum_{u'=0}^{u-1} N_{STS, u'}$ for $u = 1, \dots, N_{user}-1$.
NOTE 1—Pre-VHT modulated fields refer to the L-STF, L-LTF, L-SIG, and VHT-SIG-A fields, while VHT modulated fields refer to the VHT-STF, VHT-LTF, VHT-SIG-B, and Data fields (see Figure 22-17).	
NOTE 2—For pre-VHT modulated fields, u is 0 only since $N_{user} = 1$.	

22.3.7 Mathematical description of signals

22.3.7.1 Notation

For a description of the conventions used for the mathematical description of the signals, see 18.3.2.5. In addition, the following notational conventions are used in Clause 22:

$[Q]_{m,n}$ indicates the element in row m and column n of matrix Q , where $1 \leq m \leq N_{row}$ and $1 \leq n \leq N_{col}$

N_{row} and N_{col} are the number of rows and columns, respectively, of the matrix Q

$[Q]_{M:N}$ indicates a matrix consisting of columns M to N of matrix Q

22.3.7.2 Subcarrier indices in use

For description on subcarrier indices over which the signal is transmitted for non-HT and HT PPDU, see 20.3.7.

For a 20 MHz VHT PPDU transmission, the 20 MHz is divided into 64 subcarriers. The signal is transmitted on subcarriers -28 to -1 and 1 to 28 , with 0 being the center (DC) subcarrier.

For a 40 MHz VHT PPDU transmission, the 40 MHz is divided into 128 subcarriers. The signal is transmitted on subcarriers -58 to -2 and 2 to 58 .

For an 80 MHz VHT PPDU transmission, the 80 MHz is divided into 256 subcarriers. The signal is transmitted on subcarriers -122 to -2 and 2 to 122 .

For a 160 MHz VHT PPDU transmission, the 160 MHz is divided into 512 subcarriers. The signal is transmitted on subcarriers -250 to -130 , -126 to -6 , 6 to 126 , and 130 to 250 .

For a noncontiguous 80+80 MHz VHT PPDU transmission, each 80 MHz frequency segment is divided into 256 subcarriers. In each frequency segment, the signal is transmitted on subcarriers -122 to -2 and 2 to 122 .

22.3.7.3 Channel frequencies

Let

$$f_{c, \text{idx}0} = \text{dot11CurrentChannelCenterFrequencyIndex0} \quad (22-1)$$

$$f_{c, \text{idx}1} = \text{dot11CurrentChannelCenterFrequencyIndex1} \quad (22-2)$$

$$f_{P20, \text{idx}} = \text{dot11CurrentPrimaryChannel} \quad (22-3)$$

$$f_{CH, \text{start}} = \text{dot11ChannelStartingFactor} \times 500 \text{ kHz} \quad (22-4)$$

where

dot11CurrentChannelCenterFrequencyIndex0, dot11CurrentChannelCenterFrequencyIndex1, and dot11CurrentPrimaryChannel are defined in Table 22-22.

When dot11CurrentChannelWidth (see Table 22-22) is 20 MHz, $f_{P20, \text{idx}} = f_{c, \text{idx}0}$. For dot11CurrentChannelWidth greater than 20 MHz, $f_{P20, \text{idx}}$ and $f_{c, \text{idx}0}$ shall have the relationship specified in Equation (22-5).

$$f_{P20, \text{idx}} = f_{c, \text{idx}0} - 4 \cdot \left(\frac{N_{20\text{MHz}}}{2} - n_{P20} \right) + 2 \quad (22-5)$$

where

$$N_{20\text{MHz}} = \begin{cases} 2, & \text{if dot11CurrentChannelWidth indicates 40 MHz} \\ 4, & \text{if dot11CurrentChannelWidth indicates 80 MHz and 80+80 MHz} \\ 8, & \text{if dot11CurrentChannelWidth indicates 160 MHz} \end{cases}$$

n_{P20} is an integer with possible range $0 \leq n_{P20} \leq N_{20\text{MHz}} - 1$

When dot11CurrentChannelWidth is 40 MHz, 80 MHz, 160 MHz, or 80+80 MHz,

- The primary 20 MHz channel is the channel with 20 MHz bandwidth centered at $f_{CH, \text{start}} + 5 \times f_{P20, \text{idx}}$ MHz.
- The secondary 20 MHz channel is the channel with 20 MHz bandwidth centered at $f_{CH, \text{start}} + 5 \times f_{S20, \text{idx}}$, where $f_{S20, \text{idx}}$ is given in Equation (22-6).

$$f_{S20, \text{idx}} = \begin{cases} f_{P20, \text{idx}} + 4, & \text{if } n_{P20} \text{ is even} \\ f_{P20, \text{idx}} - 4, & \text{if } n_{P20} \text{ is odd} \end{cases} \quad (22-6)$$

When dot11CurrentChannelWidth is 80 MHz, 160 MHz, or 80+80 MHz,

- The primary 40 MHz channel is the channel with 40 MHz bandwidth centered at $f_{CH, \text{start}} + 5 \times f_{P40, \text{idx}}$ MHz, where $f_{P40, \text{idx}}$ is given in Equation (22-7).
- The secondary 40 MHz channel is the channel with 40 MHz bandwidth centered at $f_{CH, \text{start}} + 5 \times f_{S40, \text{idx}}$ MHz, where $f_{S40, \text{idx}}$ is given in Equation (22-8).

$$f_{P40, \text{idx}} = f_{c, \text{idx}0} - 8 \cdot \left(\frac{N_{20\text{MHz}}}{4} - n_{P40} \right) + 4 \quad (22-7)$$

$$f_{S40, \text{idx}} = \begin{cases} f_{P40, \text{idx}} + 8, & \text{if } n_{P40} \text{ is even} \\ f_{P40, \text{idx}} - 8, & \text{if } n_{P40} \text{ is odd} \end{cases} \quad (22-8)$$

where $n_{P40} = \lfloor n_{P20}/2 \rfloor$ and $\lfloor x \rfloor$ is the largest integer less than or equal to x .

When dot11CurrentChannelWidth is 160 MHz,

- The primary 80 MHz channel is the channel with 80 MHz bandwidth centered at $f_{CH, \text{start}} + 5 \times f_{P80, \text{idx}}$ MHz, where $f_{P80, \text{idx}}$ is given in Equation (22-9).
- The secondary 80 MHz channel is the channel with 80 MHz bandwidth centered at $f_{CH, \text{start}} + 5 \times f_{S80, \text{idx}}$ MHz where $f_{S80, \text{idx}}$ is given in Equation (22-10).

$$f_{P80, \text{idx}} = f_{c, \text{idx}0} - 16 \cdot \left(\frac{N_{20\text{MHz}}}{8} - n_{P80} \right) + 8 \quad (22-9)$$

$$f_{S80, \text{idx}} = \begin{cases} f_{P80, \text{idx}} + 16, & \text{if } n_{P80} \text{ is even} \\ f_{P80, \text{idx}} - 16, & \text{if } n_{P80} \text{ is odd} \end{cases} \quad (22-10)$$

where $n_{P80} = \lfloor n_{P20}/4 \rfloor$.

When dot11CurrentChannelWidth is 80+80 MHz,

- The primary 80 MHz channel is the channel with 80 MHz bandwidth centered at $f_{CH, \text{start}} + 5 \times f_{P80, \text{idx}}$ MHz, where $f_{P80, \text{idx}} = f_{c, \text{idx}0}$.
- The secondary 80 MHz channel is the channel with 80 MHz bandwidth centered at $f_{CH, \text{start}} + 5 \times f_{S80, \text{idx}}$ MHz where $f_{S80, \text{idx}} = f_{c, \text{idx}1}$.

22.3.7.4 Transmitted signal

The transmitted signal is described in complex baseband signal notation. The actual transmitted signal is related to the complex baseband signal by the relation shown in Equation (22-11).

$$r_{RF}^{(i_{Seg}, i_{TX})}(t) = \text{Re} \left\{ \frac{1}{\sqrt{N_{Seg}}} r_{PPDU}^{(i_{Seg}, i_{TX})}(t) \exp(j2\pi f_c^{(i_{Seg})} t) \right\}, \quad (22-11)$$

$$i_{Seg} = 0, \dots, N_{Seg} - 1; \quad i_{TX} = 1, \dots, N_{TX}$$

where

$\text{Re}\{.\}$ represents the real part of a complex variable;

N_{Seg} represents the number of frequency segments in the transmit signal, as defined in Table 22-5;

$r_{PPDU}^{(i_{Seg}, i_{TX})}(t)$ represents the complex baseband signal of frequency segment i_{Seg} in transmit chain i_{TX} ;

$f_c^{(i_{Seg})}$ represents the center frequency of the portion of the PPDU transmitted in frequency segment i_{Seg} . Table 22-7 shows $f_c^{(i_{Seg})}$ as a function of the channel starting frequency and dot11CurrentChannelWidth (see Table 22-22) where $f_{P20, \text{idx}}$, $f_{P40, \text{idx}}$, and $f_{P80, \text{idx}}$ are given in Equation (22-4), Equation (22-5), Equation (22-7), and Equation (22-9), respectively.

NOTE—Transmitted signals may have different impairments such as phase offset or phase noise between the two frequency segments, which is not shown in Equation (22-11) for simplicity. See 22.3.18.3.

Table 22-7—Center frequency of the portion of the PPDU transmitted in frequency segment i_{seg}

dot11CurrentChannel Width	CH_BANDWIDTH	$f_c^{(i_{seg})} = f_{CH, start} + 5 \times f_{(i_{seg})}$	
		$f_{(0)}$	$f_{(1)}$
20 MHz	CBW20	$f_{c, idx0}$	—
40 MHz	CBW20	$f_{P20, idx}$	—
	CBW40	$f_{c, idx0}$	—
80 MHz	CBW20	$f_{P20, idx}$	—
	CBW40	$f_{P40, idx}$	—
	CBW80	$f_{c, idx0}$	—
160 MHz	CBW20	$f_{P20, idx}$	—
	CBW40	$f_{P40, idx}$	—
	CBW80	$f_{P80, idx}$	—
	CBW160	$f_{c, idx0}$	—
80+80 MHz	CBW20	$f_{P20, idx}$	—
	CBW40	$f_{P40, idx}$	—
	CBW80	$f_{P80, idx}$	—
	CBW80+80	$f_{c, idx0}$	$f_{c, idx1}$

The transmitted RF signal is derived by up-converting the complex baseband signal, which consists of several fields. The timing boundaries for the various fields are shown in Figure 22-17 where N_{VHTLTF} is the number of VHT-LTF symbols and is defined in Table 22-13.

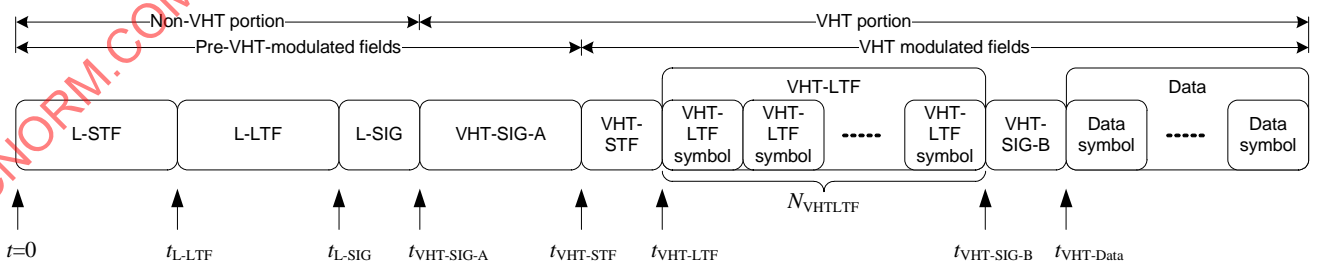

Figure 22-17—Timing boundaries for VHT PPDU fields

The time offset, t_{Field} , determines the starting time of the corresponding field.

The signal transmitted on frequency segment i_{Seg} of transmit chain i_{TX} shall be as shown in Equation (22-12).

$$\begin{aligned}
 r_{PPDU}^{(i_{Seg}, i_{TX})}(t) = & r_{L-STF}^{(i_{Seg}, i_{TX})}(t) + r_{L-LTF}^{(i_{Seg}, i_{TX})}(t - t_{L-LTF}) \\
 & + r_{L-SIG}^{(i_{Seg}, i_{TX})}(t - t_{L-SIG}) + r_{VHT-SIG-A}^{(i_{Seg}, i_{TX})}(t - t_{VHT-SIG-A}) \\
 & + r_{VHT-STF}^{(i_{Seg}, i_{TX})}(t - t_{VHT-STF}) + r_{VHT-LTF}^{(i_{Seg}, i_{TX})}(t - t_{VHT-LTF}) \\
 & + r_{VHT-SIG-B}^{(i_{Seg}, i_{TX})}(t - t_{VHT-SIG-B}) + r_{VHT-Data}^{(i_{Seg}, i_{TX})}(t - t_{VHT-Data})
 \end{aligned} \tag{22-12}$$

where

$$0 \leq i_{Seg} \leq N_{Seg} - 1$$

$$1 \leq i_{TX} \leq N_{TX}$$

$$t_{L-LTF} = T_{L-STF}$$

$$t_{L-SIG} = t_{L-LTF} + T_{L-LTF}$$

$$t_{VHT-SIG-A} = t_{L-SIG} + T_{L-SIG}$$

$$t_{VHT-STF} = t_{VHT-SIG-A} + T_{VHT-SIG-A}$$

$$t_{VHT-LTF} = t_{VHT-STF} + T_{VHT-STF}$$

$$t_{VHT-SIG-B} = t_{VHT-LTF} + N_{VHTLTF} T_{VHT-LTF}$$

$$t_{VHT-Data} = t_{VHT-SIG-B} + T_{VHT-SIG-B}$$

Each field, $r_{Field}^{(i_{Seg}, i_{TX})}(t)$, is defined as the summation of one or more subfields, where each subfield is defined to be an inverse discrete Fourier transform as specified in Equation (22-13).

$$\begin{aligned}
 r_{Subfield}^{(i_{Seg}, i_{TX})}(t) = & \frac{1}{\sqrt{N_{Field}^{Tone} N_{Norm}}} w_{Subfield}(t) \sum_{k=-N_{SR}}^{N_{SR}} \sum_{u=0}^{N_{user}-1} \sum_{m=1}^{N_{STS,u}} \left[Q_k^{(i_{Seg})} \right]_{i_{TX}, (M_u + m)} \Upsilon_{k, BW} X_{k, u}^{(i_{Seg}, m)} \\
 & \exp(j2\pi k \Delta_F (t - T_{GI, Field} - T_{CS, VHT}(M_u + m)))
 \end{aligned} \tag{22-13}$$

This general representation holds for all subfields. In the remainder of this subclause, pre-VHT modulated fields refer to the L-STF, L-LTF, L-SIG, and VHT-SIG-A fields, while VHT modulated fields refer to the VHT-STF, VHT-LTF, VHT-SIG-B, and Data fields, as shown in Figure 22-17. Total power of the time domain VHT modulated field signals summed over all transmit chains should not exceed the total power of the time domain pre-VHT modulated field signals summed over all transmit chains. For notational simplicity, the parameter BW is omitted from some bandwidth dependent terms.

In Equation (22-13) the following notions are used:

N_{Field}^{Tone} Table 22-8 summarizes the various values of N_{Field}^{Tone} as a function of bandwidth per frequency segment.

N_{Norm} For pre-VHT modulated fields, $N_{Norm} = N_{TX}$. For VHT modulated fields,

$N_{Norm} = N_{STS, total}$ where $N_{STS, total}$ is given in Table 22-6.

Table 22-8—Tone scaling factor and guard interval duration values for PHY fields

Field	$N_{\text{Field}}^{\text{Tone}}$ as a function of bandwidth per frequency segment				Guard interval duration
	20 MHz	40 MHz	80 MHz	160 MHz	
L-STF	12	24	48	96	-
L-LTF	52	104	208	416	T_{GI2}
L-SIG	52	104	208	416	T_{GI}
VHT-SIG-A	52	104	208	416	T_{GI}
VHT-STF	12	24	48	96	-
VHT-LTF	56	114	242	484	T_{GI}
VHT-SIG-B	56	114	242	484	T_{GI}
VHT-Data	56	114	242	484	T_{GI} or T_{GIS} (see NOTE 2)
NON_HT_DUP_OFDM-Data (see NOTE 1)	-	104	208	416	T_{GI}

NOTE 1—For notational convenience, NON_HT_DUP_OFDM-Data is used as a label for the Data field of a NON_HT PPDU with format type NON_HT_DUP_OFDM.

NOTE 2— T_{GI} denotes guard interval duration when TXVECTOR parameter GI_TYPE equals LONG_GI, T_{GIS} denotes short guard interval duration when TXVECTOR parameter GI_TYPE equals SHORT_GI.

$w_{T_{\text{Subfield}}}(t)$ is a windowing function. An example function, $w_{T_{\text{Subfield}}}(t)$, is given in 18.3.2.5 (Mathematical conventions in the signal descriptions). T_{Subfield} is $T_{L\text{-STF}}$ for L-STF, $T_{L\text{-LTF}}$ for L-LTF, $T_{L\text{-SIG}}$ for L-SIG, T_{SYML} for VHT-SIG-A, $T_{\text{VHT-STF}}$ for VHT-STF, $T_{\text{VHT-LTF}}$ for VHT-LTF and $T_{\text{VHT-SIG-B}}$ for VHT-SIG-B. T_{Subfield} is T_{SYM} for VHT-Data, that is T_{SYML} when not using the short guard interval (Short GI field of VHT-SIG-A is 0) and T_{SYMS} when using the short guard interval (Short GI field of VHT-SIG-A is 1).

$Q_k^{(i_{\text{seg}})}$ is the spatial mapping matrix for the subcarrier k in frequency segment i_{seg} . For pre-VHT modulated fields, $Q_k^{(i_{\text{seg}})}$ is a column vector with N_{TX} elements with element i_{TX} being $\exp(-j2\pi k\Delta_F T_{\text{CS}}^{i_{TX}})$, where $T_{\text{CS}}^{i_{TX}}$ represents the cyclic shift for transmitter chain i_{TX} whose values are given in Table 22-10. For VHT modulated fields, $Q_k^{(i_{\text{seg}})}$ is a matrix with N_{TX} rows and $N_{STS, \text{total}}$ columns.

$\Upsilon_{k, \text{BW}}$ is defined in 22.3.7.5

Δ_F is the subcarrier frequency spacing given in Table 22-5.

$X_{k, u}^{(i_{\text{seg}}, m)}$ is the frequency-domain symbol in subcarrier k of user u for frequency segment i_{seg} of space-time stream m . Some of the $X_{k, u}^{(i_{\text{seg}}, m)}$ within $-N_{SR} \leq k \leq N_{SR}$ have a value of 0. Examples of such cases include the DC tones, guard tones on each side of the transmit spectrum, as well as the

unmodulated tones of L-STF and VHT-STF fields. Note that the multiplication matrices A_{VHTLTF}^k and P_{VHTLTF} are included in the calculation of $X_{k,u}^{(i_{seg}, m)}$ for the VHT-LTF and VHT-SIG-B fields, respectively.

$T_{GI, Field}$ is the guard interval duration used for each OFDM symbol in the field. For L-STF and VHT-STF, $T_{GI, Field} = T_{GI}$ but it can be omitted from Equation (22-13) due to the periodic property of L-STF and VHT-STF over every 0.8 μ s. For the L-SIG, VHT-SIG-A, VHT-LTF, and VHT-SIG-B fields, $T_{GI, Field}$ is defined in the “Guard interval duration” column of Table 22-8.

$T_{CS, VHT}(l)$ For pre-VHT modulated fields, $T_{CS, VHT}(l) = 0$. For VHT modulated fields, $T_{CS, VHT}(l)$ represents the cyclic shift per space-time stream, whose value is defined in Table 22-11.

22.3.7.5 Definition of tone rotation

The function $\Upsilon_{k, BW}$ is used to represent a rotation of the tones. BW in $\Upsilon_{k, BW}$ is determined by the TXVECTOR parameter CH_BANDWIDTH as defined in Table 22-9.

Table 22-9—CH_BANDWIDTH and $\Upsilon_{k, BW}$

CH_BANDWIDTH	$\Upsilon_{k, BW}$
CBW20	$\Upsilon_{k, 20}$
CBW40	$\Upsilon_{k, 40}$
CBW80	$\Upsilon_{k, 80}$
CBW160	$\Upsilon_{k, 160}$
CBW80+80	$\Upsilon_{k, 80}$ per frequency segment

For a 20 MHz PPDU transmission,

$$\Upsilon_{k, 20} = 1 \tag{22-14}$$

For a 40 MHz PPDU transmission,

$$\Upsilon_{k, 40} = \begin{cases} 1, & k < 0 \\ j, & k \geq 0 \end{cases} \tag{22-15}$$

For an 80 MHz PPDU transmission,

$$\Upsilon_{k, 80} = \begin{cases} 1, & k < -64 \\ -1, & k \geq -64 \end{cases} \tag{22-16}$$

For a noncontiguous 80+80 MHz PPDU transmission, each 80 MHz frequency segment shall use the phase rotation for 80 MHz PPDU transmissions as defined in Equation (22-16).

For a contiguous 160 MHz PPDU transmission,

$$\Upsilon_{k,160} = \begin{cases} 1, & k < -192 \\ -1, & -192 \leq k < 0 \\ 1, & 0 \leq k < 64 \\ -1, & 64 \leq k \end{cases} \quad (22-17)$$

22.3.8 VHT preamble

22.3.8.1 Introduction

A VHT preamble is defined to carry the required information to operate in either single user or multi-user mode. To ensure compatibility with non-VHT STAs, specific non-VHT fields are defined that can be received by non-VHT STAs compliant with Clause 18 or Clause 20. The non-VHT fields are followed by VHT fields specific to VHT STAs.

22.3.8.2 Non-VHT portion of VHT format preamble

22.3.8.2.1 Cyclic shift for pre-VHT modulated fields

The cyclic shift value $T_{CS}^{i_{TX}}$ for the L-STF, L-LTF, L-SIG, and VHT-SIG-A fields of the PPDU for transmit chain i_{TX} out of a total of N_{TX} are defined in Table 22-10.

Table 22-10—Cyclic shift values for L-STF, L-LTF, L-SIG, and VHT-SIG-A fields of the PPDU

$T_{CS}^{i_{TX}}$ values for L-STF, L-LTF, L-SIG, and VHT-SIG-A fields of the PPDU									
Total number of transmit chains (N_{TX})	Cyclic shift for transmit chain i_{TX} (in units of ns)								
	1	2	3	4	5	6	7	8	>8
1	0	–	–	–	–	–	–	–	–
2	0	–200	–	–	–	–	–	–	–
3	0	–100	–200	–	–	–	–	–	–
4	0	–50	–100	–150	–	–	–	–	–
5	0	–175	–25	–50	–75	–	–	–	–
6	0	–200	–25	–150	–175	–125	–	–	–
7	0	–200	–150	–25	–175	–75	–50	–	–
8	0	–175	–150	–125	–25	–100	–50	–200	–
>8	0	–175	–150	–125	–25	–100	–50	–200	Between –200 and 0 inclusive

22.3.8.2.2 L-STF definition

The L-STF field for a 20 MHz or 40 MHz transmission is defined by Equation (20-8) and Equation (20-9), respectively, in 20.3.9.3.3 (L-STF definition). For 80 MHz, the L-STF field is defined by Equation (22-18). Note that these equations do not include the phase rotation per 20 MHz subchannel.

$$S_{-122, 122} = \{S_{-58, 58}, 0, 0, 0, 0, 0, 0, 0, 0, 0, 0, 0, S_{-58, 58}\} \quad (22-18)$$

where

$S_{-58, 58}$ is defined in Equation (20-9)

For 160 MHz, the L-STF is defined by Equation (22-19).

$$S_{-250, 250} = \{S_{-122, 122}, 0, 0, 0, 0, 0, 0, 0, 0, 0, 0, 0, S_{-122, 122}\} \quad (22-19)$$

where

$S_{-122, 122}$ is defined in Equation (22-18)

For a noncontiguous transmission using two 80 MHz frequency segments, each 80 MHz frequency segment shall use the L-STF pattern for the 80 MHz ($S_{-122, 122}$) defined in Equation (22-18).

The time domain representation of the signal on frequency segment i_{Seg} in transmit chain i_{TX} shall be as specified in Equation (22-20).

$$r_{L-STF}^{(i_{Seg}, i_{TX})}(t) = \frac{1}{\sqrt{N_{L-STF}^{Tone} N_{TX}}} w_{T_{L-STF}}(t) \sum_{k=-N_{SR}}^{N_{SR}} Y_{k, BW} S_k \exp(j2\pi k \Delta_F (t - T_{CS}^{i_{TX}})) \quad (22-20)$$

where

$T_{CS}^{i_{TX}}$ represents the cyclic shift for transmit chain i_{TX} with a value given in Table 22-10

$Y_{k, BW}$ is defined by Equation (22-14), Equation (22-15), Equation (22-16). and Equation (22-17)

N_{L-STF}^{Tone} has the value given in Table 22-8

22.3.8.2.3 L-LTF definition

For a 20 MHz or 40 MHz transmission, the L-LTF pattern in the VHT preamble is defined by Equation (20-11) and Equation (20-12) in 20.3.9.3.4 (L-LTF definition), respectively. For an 80 MHz transmission, the L-LTF pattern is defined by Equation (22-21). Note that these equations do not include the phase rotation per 20 MHz subchannel.

$$L_{-122, 122} = \{L_{-58, 58}, 0, 0, 0, 0, 0, 0, 0, 0, 0, 0, 0, L_{-58, 58}\} \quad (22-21)$$

where

$L_{-58, 58}$ is defined in Equation (20-12)

For a 160 MHz transmission, the L-LTF is defined by Equation (22-22). Note that this equation does not include the phase rotations per 20 MHz subchannel.

$$L_{-250, 250} = \{L_{-122, 122}, 0, 0, 0, 0, 0, 0, 0, 0, 0, 0, 0, 0, L_{-122, 122}\} \quad (22-22)$$

where

$L_{-122, 122}$ is given by Equation (22-21)

For noncontiguous transmissions using two 80 MHz frequency segments, each 80 MHz frequency segment shall use the L-LTF pattern for the 80 MHz L-LTF pattern ($L_{-122, 122}$) defined in Equation (22-21).

The time domain representation of the signal on transmit chain i_{TX} shall be as defined in Equation (22-23)

$$r_{L-LTF}^{(i_{Seg}, i_{TX})}(t) = \frac{1}{\sqrt{N_{L-LTF}^{Tone} N_{TX}}} w_{T_{L-LTF}}(t) \sum_{k=-N_{SR}}^{N_{SR}} \Upsilon_{k, BW} L_k \exp(j2\pi k \Delta_F (t - T_{GI2} - T_{CS}^{i_{TX}})) \quad (22-23)$$

where

$T_{CS}^{i_{TX}}$ represents the cyclic shift for transmitter chain i_{TX} with a value given in Table 22-10

$\Upsilon_{k, BW}$ is defined by Equation (22-14), Equation (22-15), Equation (22-16), and Equation (22-17)

N_{L-LTF}^{Tone} has the value given in Table 22-8

22.3.8.2.4 L-SIG definition

The L-SIG field is used to communicate rate and length information. The structure of the L-SIG field is defined in Figure 18-5.

In a VHT PPDU, the RATE field shall be set to the value representing 6 Mb/s in the 20 MHz channel spacing column of Table 18-6. In a non-HT duplicate PPDU, the RATE field is defined in 18.3.4.2 using the L_DATARATE parameter in the TXVECTOR.

The LENGTH field shall be set to the value given by Equation (22-24).

$$\text{Length} = \frac{\text{TXTIME} - 20}{4} \times 3 - 3 \quad (22-24)$$

where

TXTIME (in μs) is defined in 22.4.3

The LSB of the binary expression of the Length value shall be mapped to B5. In a non-HT duplicate PPDU, the LENGTH field is defined in 18.3.4.3 using the L_LENGTH parameter in the TXVECTOR.

The Reserved (R) field shall be set to 0.

The Parity (P) field has the even parity of bits 0-16.

The SIGNAL TAIL field shall be set to 0.

The L-SIG field shall be encoded, interleaved, and mapped following the steps described in 18.3.5.6, 18.3.5.7, and 18.3.5.8. The stream of 48 complex numbers generated by these steps is denoted by $d_k, k = 0, \dots, 47$. Pilots shall be inserted as described in 18.3.5.9. The time domain waveform of the L-SIG field shall be as given by Equation (22-25).

$$r_{L-SIG}^{(i_{Seg}, i_{TX})}(t) = \frac{1}{\sqrt{N_{L-SIG}^{Tone} N_{TX}}} w_{T_{L-SIG}}(t) \cdot \sum_{i_{BW}=0}^{N_{20MHz}-1} \sum_{k=-26}^{26} \left(Y_{(k-K_{Shift}(i_{BW}), BW)(D_{k,20} + p_0 P_k)} \cdot \exp(j2\pi(k - K_{Shift}(i_{BW}))\Delta_F(t - T_{GI} - T_{CS}^{i_{TX}})) \right) \quad (22-25)$$

where

N_{20MHz} is defined in 22.3.7.3

$K_{Shift}(i) = (N_{20MHz} - 1 - 2i) \cdot 32$

$$D_{k,20} = \begin{cases} 0, & k = 0, \pm 7, \pm 21 \\ d_{M_{20}^r(k)}, & \text{otherwise} \end{cases} \quad (22-26)$$

$$M_{20}^r(k) = \begin{cases} k + 26, & -26 \leq k \leq -22 \\ k + 25, & -20 \leq k \leq -8 \\ k + 24, & -6 \leq k \leq -1 \\ k + 23, & 1 \leq k \leq 6 \\ k + 22, & 8 \leq k \leq 20 \\ k + 21, & 22 \leq k \leq 26 \end{cases} \quad (22-27)$$

P_k is defined in 18.3.5.10

p_0 is the first pilot value in the sequence defined in 18.3.5.10

N_{L-SIG}^{Tone} has the value given in Table 22-8

$Y_{k,BW}$ is defined in Equation (22-14), Equation (22-15), Equation (22-16), and Equation (22-17)

$T_{CS}^{i_{TX}}$ represents the cyclic shift for transmitter chain i_{TX} with a value given in Table 22-10

NOTE— $M_{20}^r(k)$ is a “reverse” function of the function $M(k)$ defined in 18.3.5.10.

22.3.8.3 VHT portion of VHT format preamble

22.3.8.3.1 Introduction

The VHT portion of the VHT format preamble consists of the VHT-SIG-A, VHT-STF, VHT-LTF, and VHT-SIG-B fields.

22.3.8.3.2 Cyclic shift for VHT modulated fields

The cyclic shift values defined in this subclause apply to the VHT-STF, VHT-LTF, VHT-SIG-B, and Data fields of the VHT PPDU. The cyclic shift values defined in 22.3.8.2.1 apply to VHT-SIG-A field in the VHT format preamble.

Throughout the VHT modulated fields of the preamble, cyclic shifts are applied to prevent unintended beamforming when correlated signals are transmitted in multiple space-time streams. The same cyclic shift is also applied to these streams during the transmission of the Data field of the VHT PPDU. The cyclic shift value $T_{CS, VHT}(n)$ for the VHT modulated fields for space-time stream n out of $N_{STS, total}$ total space-time streams is shown in Table 22-11.

Table 22-11—Cyclic shift values for the VHT modulated fields of a PPDU

$T_{CS, VHT}(n)$ values for the VHT modulated fields of a PPDU								
Total number of space-time streams ($N_{STS, total}$)	Cyclic shift for space-time stream n (ns)							
	1	2	3	4	5	6	7	8
1	0	–	–	–	–	–	–	–
2	0	–400	–	–	–	–	–	–
3	0	–400	–200	–	–	–	–	–
4	0	–400	–200	–600	–	–	–	–
5	0	–400	–200	–600	–350	–	–	–
6	0	–400	–200	–600	–350	–650	–	–
7	0	–400	–200	–600	–350	–650	–100	–
8	0	–400	–200	–600	–350	–650	–100	–750

In a VHT MU PPDU, the cyclic shifts are applied sequentially across the space-time streams as follows: the cyclic shift of the space-time stream number m of user u is given by $T_{CS, VHT}(M_u + m)$ of the row corresponding to $N_{STS, total}$ in Table 22-11.

22.3.8.3.3 VHT-SIG-A definition

The VHT-SIG-A field carries information required to interpret VHT PPDUs. The structure of the VHT-SIG-A field for the first part (VHT-SIG-A1) is shown in Figure 22-18 and for the second part (VHT-SIG-A2) is shown in Figure 22-19.

NOTE—Integer fields are represented in unsigned binary format with the least significant bit in the lowest numbered bit position.

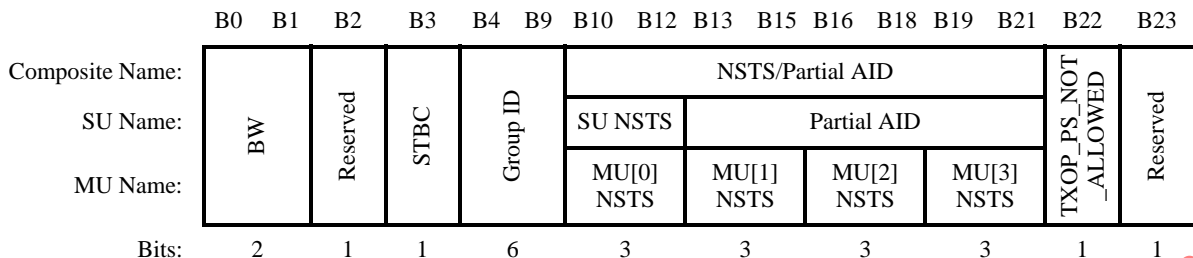

Figure 22-18—VHT-SIG-A1 structure

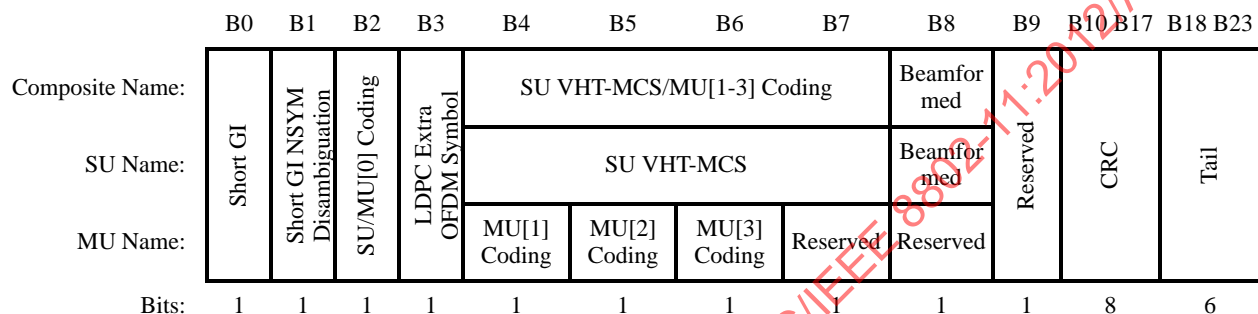

Figure 22-19—VHT-SIG-A2 structure

The VHT-SIG-A field contains the fields listed in Table 22-12. The mapping of the fields is also described in Table 22-12. Note that the mapping of the STBC field, the NSTS/Partial AID field, the SU/MU[0] Coding field, the SU VHT-MCS/MU[1-3] Coding field, and the Beamformed field is different for VHT SU and MU PPDUs.

The VHT-SIG-A field is composed of two parts, VHT-SIG-A1 and VHT-SIG-A2, each containing 24 data bits, as shown in Table 22-12. VHT-SIG-A1 is transmitted before VHT-SIG-A2. The VHT-SIG-A symbols shall be BCC encoded at rate, $R = 1/2$, be interleaved, be mapped to a BPSK constellation, and have pilots inserted following the steps described in 18.3.5.6, 18.3.5.7, 18.3.5.8, and 18.3.5.9, respectively. The first and second half of the stream of 96 complex numbers generated by these steps (before pilot insertion) is divided into two groups of 48 complex numbers $d_{k,n}$, $k = 0 \dots 47$, where $n = 0, 1$, respectively. The first 48 complex numbers form the first symbol of VHT-SIG-A and the second 48 complex numbers form the second symbol of VHT-SIG-A after rotating by 90° counter-clockwise relative to the first symbol. The first symbol of VHT-SIG-A, which does not have the 90° rotation, is used to differentiate VHT PPDUs from HT PPDUs, while the second symbol of VHT-SIG-A, which has the 90° rotation, is used to differentiate VHT PPDUs from non-HT PPDUs. The time domain waveform for the VHT-SIG-A field in a VHT PDU shall be as specified in Equation (22-28).

Table 22-12—Fields in the VHT-SIG-A field

Two parts of VHT-SIG-A	Bit	Field	Number of bits	Description
VHT-SIG-A1	B0-B1	BW	2	Set to 0 for 20 MHz, 1 for 40 MHz, 2 for 80 MHz, and 3 for 160 MHz and 80+80 MHz
	B2	Reserved	1	Reserved. Set to 1.
	B3	STBC	1	For a VHT SU PPDU: Set to 1 if space time block coding is used and set to 0 otherwise. For a VHT MU PPDU: Set to 0.
	B4-B9	Group ID	6	Set to the value of the TXVECTOR parameter GROUP_ID. A value of 0 or 63 indicates a VHT SU PPDU; otherwise, indicates a VHT MU PPDU.
	B10-B21	NSTS/Partial AID	12	For a VHT MU PPDU: NSTS is divided into 4 user positions of 3 bits each. User position p , where $0 \leq p \leq 3$, uses bits $B(10 + 3p)$ to $B(12 + 3p)$. The number of space-time streams for user u are indicated at user position $p = \text{USER_POSITION}[u]$ where $u = 0, 1, \dots, \text{NUM_USERS} - 1$ and the notation $A[b]$ denotes the value of array A at index b . Zero space-time streams are indicated at positions not listed in the USER_POSITION array. Each user position is set as follows: Set to 0 for 0 space-time streams Set to 1 for 1 space-time stream Set to 2 for 2 space-time streams Set to 3 for 3 space-time streams Set to 4 for 4 space-time streams Values 5-7 are reserved For a VHT SU PPDU: B10-B12 Set to 0 for 1 space-time stream Set to 1 for 2 space-time streams Set to 2 for 3 space-time streams Set to 3 for 4 space-time streams Set to 4 for 5 space-time streams Set to 5 for 6 space-time streams Set to 6 for 7 space-time streams Set to 7 for 8 space-time streams B13-B21 Partial AID: Set to the value of the TXVECTOR parameter PARTIAL_AID. Partial AID provides an abbreviated indication of the intended recipient(s) of the PSDU (see 9.17a).
	B22	TXOP_PS_NOT_ALLOWED	1	Set to 0 by VHT AP if it allows non-AP VHT STAs in TXOP power save mode to enter Doze state during a TXOP. Set to 1 otherwise. The bit is reserved and set to 1 in VHT PPDU _s transmitted by a non-AP VHT STA.
	B23	Reserved	1	Set to 1

Table 22-12—Fields in the VHT-SIG-A field (continued)

Two parts of VHT-SIG-A	Bit	Field	Number of bits	Description
VHT-SIG-A2	B0	Short GI	1	Set to 0 if short guard interval is not used in the Data field. Set to 1 if short guard interval is used in the Data field.
	B1	Short GI N_{SYM} Disambiguation	1	Set to 1 if short guard interval is used and $N_{SYM} \bmod 10 = 9$; otherwise, set to 0. N_{SYM} is defined in 22.4.3.
	B2	SU/MU[0] Coding	1	For a VHT SU PPDU, B2 is set to 0 for BCC, 1 for LDPC. For a VHT MU PPDU, if the MU[0] NSTS field is nonzero, then B2 indicates the coding used for user u with $USER_POSITION[u] = 0$; set to 0 for BCC and 1 for LDPC. If the MU[0] NSTS field is 0, then this field is reserved and set to 1.
	B3	LDPC Extra OFDM Symbol	1	Set to 1 if the LDPC PPDU encoding process (if an SU PPDU), or at least one LDPC user's PPDU encoding process (if a VHT MU PPDU), results in an extra OFDM symbol (or symbols) as described in 22.3.10.5.4 and 22.3.10.5.5. Set to 0 otherwise.
	B4-B7	SU VHT- MCS/MU[1- 3] Coding	4	For a VHT SU PPDU: VHT-MCS index For a VHT MU PPDU: If the MU[1] NSTS field is nonzero, then B4 indicates coding for user u with $USER_POSITION[u] = 1$: set to 0 for BCC, 1 for LDPC. If the MU[1] NSTS field is 0, then B4 is reserved and set to 1. If the MU[2] NSTS field is nonzero, then B5 indicates coding for user u with $USER_POSITION[u] = 2$: set to 0 for BCC, 1 for LDPC. If the MU[2] NSTS field is 0, then B5 is reserved and set to 1. If the MU[3] NSTS field is nonzero, then B6 indicates coding for user u with $USER_POSITION[u] = 3$: set to 0 for BCC, 1 for LDPC. If the MU[3] NSTS field is 0, then B6 is reserved and set to 1. B7 is reserved and set to 1
	B8	Beamformed	1	For a VHT SU PPDU: Set to 1 if a Beamforming steering matrix is applied to the waveform in an SU transmission as described in 20.3.11.11.2, set to 0 otherwise. For a VHT MU PPDU: Reserved and set to 1 NOTE—If equal to 1 smoothing is not recommended.
	B9	Reserved	1	Reserved and set to 1
	B10-B17	CRC	8	CRC calculated as in 20.3.9.4.4 with c_7 in B10. Bits 0-23 of HT-SIG1 and bits 0-9 of HT-SIG2 are replaced by bits 0-23 of VHT-SIG-A1 and bits 0-9 of VHT-SIG-A2, respectively.
	B18-B23	Tail	6	Used to terminate the trellis of the convolutional decoder. Set to 0.

$$r_{\text{VHT-SIG-A}}^{(i_{\text{Seg}}, i_{\text{TX}})}(t) = \frac{1}{\sqrt{N_{\text{VHT-SIG-A}}^{\text{Tone}} N_{\text{TX}}}} \sum_{n=0}^1 w_{T_{\text{SYM}}}(t - nT_{\text{SYM}}) \quad (22-28)$$

$$\sum_{i_{\text{BW}}=0}^{N_{20\text{MHz}}-1} \left(\sum_{k=-26}^{26} Y_{(k - K_{\text{Shift}}(i_{\text{BW}})), \text{BW}}(j^n D_{k, n, \text{BW}} + p_{n+1} P_k) \cdot \exp(j2\pi(k - K_{\text{Shift}}(i_{\text{BW}}))\Delta_F(t - nT_{\text{SYM}} - T_{\text{GI}} - T_{\text{CS}}^{i_{\text{TX}}})) \right)$$

where

$N_{20\text{MHz}}$ and $K_{\text{Shift}}(i)$ are defined in 22.3.8.2.4

$$D_{k, n, 20} = \begin{cases} 0, & k = 0, \pm 7, \pm 21 \\ d_{M_{20}^r(k), n}, & \text{otherwise} \end{cases}$$

$M_{20}^r(k)$ is defined in Equation (22-27)

P_k and p_n are defined in 18.3.5.10

$N_{\text{VHT-SIG-A}}^{\text{Tone}}$ has the value given in Table 22-8

$Y_{k, \text{BW}}$ is defined in Equation (22-14), Equation (22-15), Equation (22-16), and Equation (22-17)

$T_{\text{CS}}^{i_{\text{TX}}}$ represents the cyclic shift for transmitter chain i_{TX} with a value given in Table 22-10

NOTE—This definition results in a QPSK modulation on the second symbol of VHT-SIG-A where the constellation of the data tones is rotated by 90° counter-clockwise relative to the first symbol of VHT-SIG-A and relative to the non-HT signal field in VHT PPDU (Figure 22-20). In VHT PPDU, the VHT-SIG-A is transmitted with the same number of subcarriers and the same cyclic shifts as the preceding non-HT portion of the preamble.

For a noncontiguous 80+80 MHz transmission, each frequency segment shall use the time domain waveform for 80 MHz transmissions.

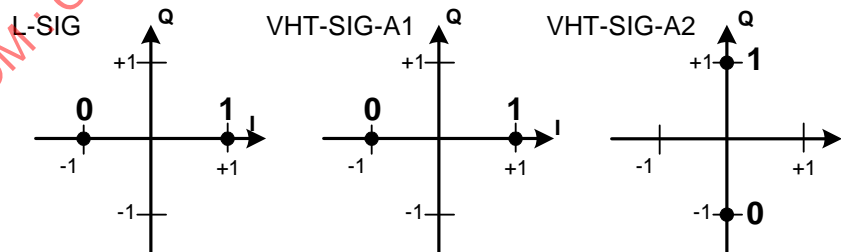

Figure 22-20—Data tone constellation in the VHT PDU pre-VHT modulated fields

22.3.8.3.4 VHT-STF definition

The main purpose of the VHT-STF field is to improve automatic gain control estimation in a MIMO transmission. The duration of the VHT-STF field is $T_{VHT-STF}$ regardless of the Short GI field setting in VHT-SIG-A. The frequency domain sequence used to construct the VHT-STF field in a 20 MHz transmission is identical to the L-STF field. In a 40 MHz and an 80 MHz transmission, the VHT-STF field is constructed from the 20 MHz version by frequency shifting a duplicate of it to each 20 MHz subchannel and applying appropriate phase rotations per 20 MHz subchannel.

For a 20 MHz transmission, the frequency domain sequence is given by Equation (22-29).

$$VHTS_{-28, 28} = HTS_{-28, 28} \quad (22-29)$$

where

$HTS_{-28, 28}$ is defined in Equation (20-19)

For a 40 MHz transmission, the frequency domain sequence is given by Equation (22-30).

$$VHTS_{-58, 58} = HTS_{-58, 58} \quad (22-30)$$

where

$HTS_{-58, 58}$ is defined in Equation (20-20)

For an 80 MHz transmission, the frequency domain sequence is given by Equation (22-31).

$$VHTS_{-122, 122} = \{VHTS_{-58, 58}, 0, 0, 0, 0, 0, 0, 0, 0, 0, 0, 0, VHTS_{-58, 58}\} \quad (22-31)$$

where

$VHTS_{-58, 58}$ is given by Equation (22-30)

For a 160 MHz transmission, the frequency domain sequence is given by Equation (22-32).

$$VHTS_{-250, 250} = \{VHTS_{-122, 122}, 0, 0, 0, 0, 0, 0, 0, 0, 0, 0, 0, VHTS_{-122, 122}\} \quad (22-32)$$

where

$VHTS_{-122, 122}$ is given by Equation (22-31)

NOTE—Equation (22-29), Equation (22-30), Equation (22-31), and Equation (22-32) do not show the phase rotation per 20 MHz subchannel.

For a noncontiguous 80+80 MHz transmission, each 80 MHz frequency segment shall use the VHT-STF pattern for the 80 MHz ($VHTS_{-122, 122}$) defined in Equation (22-31).

The time domain representation of the signal on frequency segment i_{Seg} of transmit chain i_{TX} shall be as specified in Equation (22-33).

$$r_{\text{VHT-STF}}^{(i_{\text{Seg}}, i_{\text{TX}})}(t) = \frac{1}{\sqrt{N_{\text{VHT-STF}}^{\text{Tone}} N_{\text{STS}, \text{total}}}} w_{T_{\text{VHT-STF}}}(t) \cdot \sum_{k=-N_{\text{SR}}}^{N_{\text{SR}}} \sum_{u=0}^{N_{\text{user}}-1} \sum_{m=1}^{N_{\text{STS}, u}} \left(\left[Q_k^{(i_{\text{Seg}})} \right]_{i_{\text{TX}}, (M_u + m)} \Upsilon_{k, \text{BW}}^{\text{VHTS}_k} \cdot \exp(j2\pi k \Delta_F (t - T_{\text{CS}, \text{VHT}}(M_u + m))) \right) \quad (22-33)$$

where

$N_{\text{VHT-STF}}^{\text{Tone}}$ has the value given in Table 22-8

$T_{\text{CS}, \text{VHT}}(n)$ is given in Table 22-11

$Q_k^{(i_{\text{Seg}})}$ is defined in 22.3.10.11.1

$\Upsilon_{k, \text{BW}}$ is defined in Equation (22-14), Equation (22-15), Equation (22-16), and Equation (22-17)

22.3.8.3.5 VHT-LTF definition

The VHT Long Training field (VHT-LTF) field provides a means for the receiver to estimate the MIMO channel between the set of constellation mapper outputs (or, if STBC is applied, the STBC encoder outputs) and the receive chains. The transmitter provides training for $N_{\text{STS}, \text{total}}$ space-time streams (spatial mapper inputs) used for the transmission of the PSDU(s). For each tone the MIMO channel that can be estimated is an $N_{\text{RX}} \times N_{\text{STS}, \text{total}}$ matrix. A VHT transmission has a preamble that contains VHT-LTF symbols, where the data tones of each VHT-LTF symbol are multiplied by entries belonging to a matrix P_{VHTLTF} , to enable channel estimation at the receiver. The pilot tones of each VHT-LTF symbol are multiplied by the entries of a matrix R_{VHTLTF} defined in the following text. The multiplication of the pilot tones in the VHT-LTF symbol by the R_{VHTLTF} matrix instead of the P_{VHTLTF} matrix allows receivers to track phase and frequency offset during MIMO channel estimation using the VHT-LTF. The number of VHT-LTF symbols, N_{VHTLTF} , is a function of the total number of space-time streams $N_{\text{STS}, \text{total}}$ as shown in Table 22-13. As a result the VHT-LTF field consists of one, two, four, six or eight symbols.

Table 22-13—Number of VHT-LTFs required for different numbers of space-time streams

$N_{\text{STS}, \text{total}}$	N_{VHTLTF}
1	1
2	2
3	4
4	4
5	6
6	6
7	8
8	8

Let LTF_{left} and LTF_{right} be the sequences defined in Equation (22-34) and Equation (22-35), respectively.

FOR VERY HIGH THROUGHPUT FOR OPERATION IN BANDS BELOW 6 GHz

IEEE
Std 802.11ac-2013

$$LTF_{\text{left}} = \{1, 1, -1, -1, 1, 1, -1, 1, -1, 1, 1, 1, 1, 1, 1, -1, -1, 1, 1, -1, 1, -1, 1, 1, 1, 1\} \quad (22-34)$$

$$LTF_{\text{right}} = \{1, -1, -1, 1, 1, -1, 1, -1, 1, -1, -1, -1, -1, -1, 1, 1, -1, -1, 1, -1, 1, -1, 1, 1, 1, 1\} \quad (22-35)$$

NOTE— LTF_{left} is identical to the leftmost 26 elements of Equation (17-9), and LTF_{right} is identical to the rightmost 26 elements of Equation (17-9).

In a 20 MHz transmission, the VHT-LTF sequence transmitted is given by Equation (22-36).

$$\begin{aligned} VHTLTF_{-28, 28} &= \{1, 1, LTF_{\text{left}}, 0, LTF_{\text{right}}, -1, -1\} \\ &= HTLTF_{-28, 28} \end{aligned} \quad (22-36)$$

where

$HTLTF_{-28, 28}$ is defined in Equation (20-23)

In a 40 MHz transmission, the VHT-LTF sequence transmitted is given by Equation (22-37).

$$\begin{aligned} VHTLTF_{-58, 58} &= \{LTF_{\text{left}}, 1, LTF_{\text{right}}, -1, -1, -1, 1, 0, 0, 0, -1, 1, 1, -1, LTF_{\text{left}}, 1, LTF_{\text{right}}\} \\ &= HTLTF_{-58, 58} \end{aligned} \quad (22-37)$$

where

$HTLTF_{-58, 58}$ is defined in Equation (20-24)

In an 80 MHz transmission, the VHT-LTF sequence transmitted is given by Equation (22-38).

$$\begin{aligned} VHTLTF_{-122, 122} &= \{LTF_{\text{left}}, 1, LTF_{\text{right}}, -1, -1, -1, 1, 1, -1, 1, -1, 1, 1, -1, LTF_{\text{left}}, 1, LTF_{\text{right}}, \\ &\quad 1, -1, 1, -1, 0, 0, 0, 1, -1, -1, 1, \\ &\quad LTF_{\text{left}}, 1, LTF_{\text{right}}, -1, -1, -1, 1, 1, -1, 1, -1, 1, 1, -1, LTF_{\text{left}}, 1, LTF_{\text{right}}\} \end{aligned} \quad (22-38)$$

In a 160 MHz transmission, the VHT-LTF sequence transmitted is given by Equation (22-39).

$$VHTLTF_{-250, 250} = \{VHTLTF_{-122, 122}, 0, 0, 0, 0, 0, 0, 0, 0, 0, 0, 0, 0, VHTLTF_{-122, 122}\} \quad (22-39)$$

where

$VHTLTF_{-122, 122}$ is given in Equation (22-38)

NOTE—Equation (22-36), Equation (22-37), Equation (22-38), and Equation (22-39) do not show the phase rotation per 20 MHz subchannel.

For a noncontiguous 80+80 MHz transmission, each 80 MHz frequency segment shall use the 80 MHz VHT-LTF sequence, $VHTLTF_{-122, 122}$, defined in Equation (22-38).

The generation of the time domain VHT-LTF symbols per frequency segment is shown in Figure 22-21 where A_{VHTLTF}^k is given in Equation (22-40).

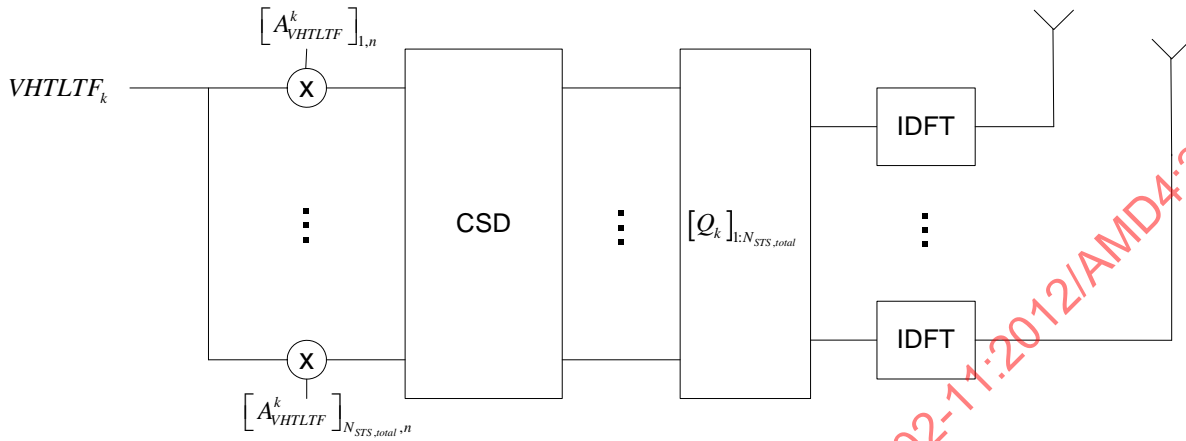

Figure 22-21—Generation of VHT-LTF symbols per frequency segment

$$A_{VHTLTF}^k = \begin{cases} R_{VHTLTF}, & \text{if } k \in K_{\text{Pilot}} \\ P_{VHTLTF}, & \text{otherwise} \end{cases} \quad (22-40)$$

where

K_{Pilot} is the set of subcarrier indices for the pilot tones.

For a 20 MHz transmission, $K_{\text{Pilot}} = \{\pm 7, \pm 21\}$.

For a 40 MHz transmission, $K_{\text{Pilot}} = \{\pm 11, \pm 25, \pm 53\}$.

For an 80 MHz transmission, $K_{\text{Pilot}} = \{\pm 11, \pm 39, \pm 75, \pm 103\}$.

For a 160 MHz transmission, $K_{\text{Pilot}} = \{\pm 25, \pm 53, \pm 89, \pm 117, \pm 139, \pm 167, \pm 203, \pm 231\}$.

For a noncontiguous 80+80 MHz transmission, K_{Pilot} for each 80 MHz frequency segment is identical to K_{Pilot} for an 80 MHz transmission.

R_{VHTLTF} is a $N_{VHTLTF} \times N_{VHTLTF}$ matrix whose elements are defined in Equation (22-41).

$$[R_{VHTLTF}]_{m,n} = [P_{VHTLTF}]_{1,n}, \quad 1 \leq m, n \leq N_{VHTLTF} \quad (22-41)$$

The time domain representation of the waveform transmitted on frequency segment i_{Seg} of transmit chain i_{TX} shall be as described by Equation (22-42).

$$r_{\text{VHT-LTF}}^{(i_{\text{Seg}}, i_{\text{TX}})}(t) = \frac{1}{\sqrt{N_{\text{Tone}} N_{\text{VHT-LTF}} N_{\text{STS, total}}}} \sum_{n=0}^{N_{\text{VHT-LTF}}-1} w_{T_{\text{VHT-LTF}}}(t - nT_{\text{VHT-LTF}}) \cdot \left(\sum_{k=-N_{\text{SR}}}^{N_{\text{SR}}} \sum_{u=0}^{N_{\text{user}}-1} \sum_{m=1}^{N_{\text{STS},u}} \left([Q_k^{(i_{\text{Seg}})}]_{i_{\text{TX}}, (M_u+m)} \Upsilon_{k, \text{BW}} [A_{VHTLTF}^k]_{(M_u+m), (n+1)}^{VHTLTF_k} \right) \cdot \exp(j2\pi k \Delta_f (t - nT_{\text{VHT-LTF}} - T_{\text{GI}} - T_{\text{CS,VHT}}(M_u + m))) \right) \quad (22-42)$$

where

$N_{\text{VHT-LTF}}^{\text{Tone}}$ has the value given in Table 22-8

$T_{\text{CS,VHT}}(n)$ is given in Table 22-11

$Q_k^{(i_{\text{seg}})}$ is defined in 22.3.10.11.1

$\Upsilon_{k,\text{BW}}$ is defined in Equation (22-14), Equation (22-15), Equation (22-16), and Equation (22-17)

A_{VHTLTF}^k is defined in Equation (22-40)

$$P_{\text{VHTLTF}} = \begin{cases} P_{4 \times 4}, N_{\text{STS},\text{total}} \leq 4 \\ P_{6 \times 6}, N_{\text{STS},\text{total}} = 5, 6 \\ P_{8 \times 8}, N_{\text{STS},\text{total}} = 7, 8 \end{cases} \quad (22-43)$$

where

$P_{4 \times 4}$ is defined in Equation (20-27)

The VHT-LTF mapping matrix for six VHT-LTF symbols, $P_{6 \times 6}$, is defined in Equation (22-44).

$$P_{6 \times 6} = \begin{bmatrix} 1 & -1 & 1 & 1 & 1 & -1 \\ 1 & -w^1 & w^2 & w^3 & w^4 & -w^5 \\ 1 & -w^2 & w^4 & w^6 & w^8 & -w^{10} \\ 1 & -w^3 & w^6 & w^9 & w^{12} & -w^{15} \\ 1 & -w^4 & w^8 & w^{12} & w^{16} & -w^{20} \\ 1 & -w^5 & w^{10} & w^{15} & w^{20} & -w^{25} \end{bmatrix} \quad (22-44)$$

where

$$w = \exp(-j2\pi/6)$$

The VHT-LTF mapping matrix for eight VHT-LTF symbols, $P_{8 \times 8}$, is defined in Equation (22-45).

$$P_{8 \times 8} = \begin{bmatrix} P_{4 \times 4} & P_{4 \times 4} \\ P_{4 \times 4} & -P_{4 \times 4} \end{bmatrix} \quad (22-45)$$

where

$P_{4 \times 4}$ is defined in Equation (20-27)

As defined in Table 22-5, the duration of each VHT-LTF symbol is $T_{\text{VHT-LTF}}$ regardless of the Short GI field setting in VHT-SIG-A.

22.3.8.3.6 VHT-SIG-B definition

The VHT-SIG-B field is one symbol and contains 26 bits in a 20 MHz PPDU, 27 bits in a 40 MHz PPDU, and 29 bits in 80 MHz, 160 MHz, and 80+80 MHz PPDU for each user. The fields in the VHT-SIG-B field are listed in Table 22-14. For fields consisting of multiple bits, the LSB of the value occupies the lowest numbered bit of the field. For example, for an MU transmission using VHT-MCS 5 (0101 in binary) in 20 MHz bandwidth, the VHT-SIG-B field bits are set as follows: B16=1, B17=0, B18=1, and B19=0.

Table 22-14—Fields in the VHT-SIG-B field

Field	VHT MU PPDU Allocation (bits)			VHT SU PPDU Allocation (bits)			Description
	20 MHz	40 MHz	80 MHz, 160 MHz, 80+80 MHz	20 MHz	40 MHz	80 MHz, 160 MHz, 80+80 MHz	
VHT-SIG-B Length	B0-B15 (16)	B0-B16 (17)	B0-B18 (19)	B0-B16 (17)	B0-B18 (19)	B0-B20 (21)	Length of A-MPDU pre-EOF padding in units of four octets
VHT-MCS	B16-B19 (4)	B17-B20 (4)	B19-B22 (4)	N/A	N/A	N/A	
Reserved	N/A	N/A	N/A	B17-B19 (3)	B19-B20 (2)	B21-B22 (2)	All ones
Tail	B20-B25 (6)	B21-B26 (6)	B23-B28 (6)	B20-B25 (6)	B21-B26 (6)	B23-B28 (6)	All zeros
Total # bits	26	27	29	26	27	29	

NOTE—Due to the limitations in the maximum A-MPDU length, B19-20 will always be 0 for an 80 MHz, 160 MHz, and 80+80 MHz VHT SU PPDU.

The VHT-SIG-B Length field for user u shall be set using Equation (22-46).

$$\text{VHT-SIG-B Length (for user } u \text{ in units of 4 octets)} = \left\lceil \frac{\text{APEP_LENGTH}_u}{4} \right\rceil \quad (22-46)$$

where

APEP_LENGTH_u is the TXVECTOR parameter APEP_LENGTH for user u (in octets)

NOTE—The number of octets represented by the VHT-SIG-B Length field will not exceed the PSDU_LENGTH determined by Equation (22-112), Equation (22-113), and Equation (22-114) by more than 3 octets.

The VHT-SIG-B bits for an NDP transmission in various channel widths shall be set as defined in Table 22-15.

For a 40 MHz transmission, the VHT-SIG-B bits are repeated twice. For an 80 MHz transmission, the VHT-SIG-B bits are repeated four times and a pad bit appended that is set to 0. For a 160 MHz and 80+80 MHz transmission, the VHT-SIG-B bits are first repeated four times and a pad bit appended that is set to 0 as in the 80 MHz transmission. Then, the resulting 117 bits are repeated again to fill the 234 available bits. The repetition of the VHT-SIG-B bits for various channel width PPDU is shown in Figure 22-22.

Table 22-15—VHT-SIG-B bits (before Tail field) in NDP for various channel widths

Channel Width	B0	B1	B2	B3	B4	B5	B6	B7	B8	B9	B10	B11	B12	B13	B14	B15	B16	B17	B18	B19	B20	B21	B22
20 MHz	0	0	0	0	0	1	1	1	0	1	0	0	0	1	0	0	0	0	1	0	–	–	–
40 MHz	1	0	1	0	0	1	0	1	1	0	1	0	0	0	1	0	0	0	0	1	1	–	–
80 MHz, 160 MHz, or 80+80 MHz	0	1	0	1	0	0	1	1	0	0	1	0	1	1	1	1	1	1	1	0	0	1	0

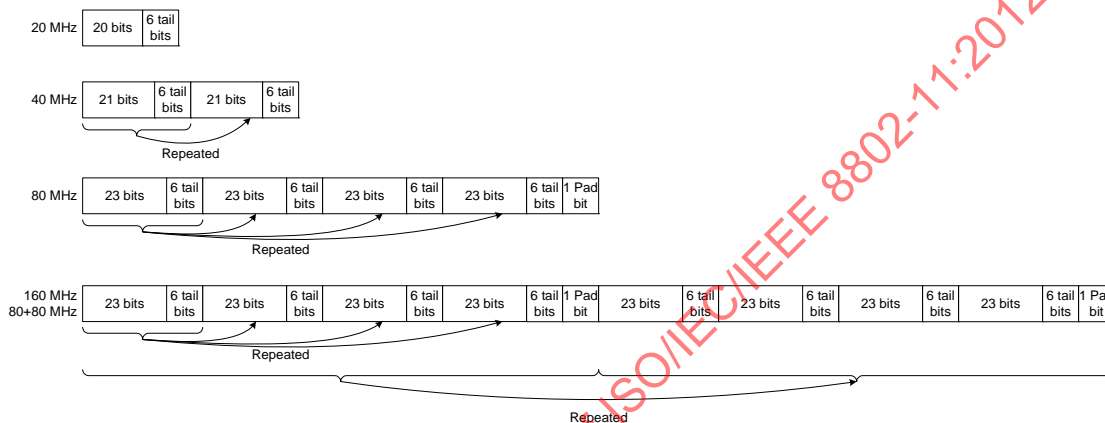

Figure 22-22—VHT-SIG-B bits in 20 MHz, 40 MHz, 80 MHz, 160 MHz, and 80+80 MHz transmissions

For each user u , the VHT-SIG-B field shall be BCC encoded at rate $R = 1/2$ as defined in 18.3.5.6, be segment parsed as defined in 22.3.10.7, be interleaved as defined in 22.3.10.8, be mapped to a BPSK constellation as defined in 18.3.5.8, and have pilots inserted following the steps described in 22.3.10.10. The VHT-SIG-B field constellation points are mapped to $N_{STS,u}$ space-time streams by the user-specific elements of the first column of the P_{VHTLTF} matrix, which is defined in clause 22.3.8.3.5. The total number of data subcarriers and pilot subcarriers are the same as in the Data field. The space-time streams per each frequency segment are input into the CSD block, which is defined in Table 22-11 and follow the same transmission flow as the Data field from there on. The duration of the VHT-SIG-B field is $T_{VHT-SIG-B}$, regardless of the value of the TXVECTOR parameter GI_TYPE. The time domain waveform for the VHT-SIG-B field in a VHT PPDU is specified by Equation (22-47).

$$\begin{aligned}
 s_{VHT-SIG-B}^{(i_{Seg}, i_{TX})}(t) &= \frac{1}{\sqrt{N_{VHT-SIG-B}^{Tone} N_{STS, total}}} w_{T_{VHT-SIG-B}}(t) \\
 &\cdot \sum_{k=-N_{SR}}^{N_{SR}} \sum_{u=0}^{N_{user}-1} \sum_{m=1}^{N_{STS,u}} \left(\left[Q_k^{(i_{Seg})} \right]_{i_{TX}, (M_u+m)} Y_{k, BW} \left(\left[P_{VHTLTF} \right]_{(M_u+m), 1} D_{k, BW}^{(u)} + p_3 P_0^k \right) \right) \\
 &\cdot \exp(j2\pi k \Delta_F (t - T_{GI} - T_{CS, VHT}(M_u + m)))
 \end{aligned} \tag{22-47}$$

where

$N_{VHT-SIG-B}^{Tone}$ has the value given in Table 22-8

$T_{CS, VHT}(n)$ is given in Table 22-11

$Q_k^{(i_{seg})}$ is defined in 22.3.10.11.1

p_n is defined in 18.3.5.10

P_n^k is defined in 22.3.10.10

$\Upsilon_{k,BW}$ is defined in Equation (22-14), Equation (22-15), Equation (22-16), and Equation (22-17)

P_{VHTLTF} is given in Equation (22-43)

For a 20 MHz VHT transmission,

$$D_{k,20}^{(u)} = \begin{cases} 0, & k = 0, \pm 7, \pm 21 \\ d_{M_{20}^{(k)}}^{(u)}, & \text{otherwise} \end{cases} \quad (22-48)$$

$$M_{20}^r(k) = \begin{cases} k + 28, & -28 \leq k \leq -22 \\ k + 27, & -20 \leq k \leq -8 \\ k + 26, & -6 \leq k \leq -1 \\ k + 25, & 1 \leq k \leq 6 \\ k + 24, & 8 \leq k \leq 20 \\ k + 23, & 22 \leq k \leq 28 \end{cases} \quad (22-49)$$

For a 40 MHz VHT transmission,

$$D_{k,40}^{(u)} = \begin{cases} 0, & k = 0, \pm 1, \pm 11, \pm 25, \pm 53 \\ d_{M_{40}^{(k)}}^{(u)}, & \text{otherwise} \end{cases} \quad (22-50)$$

$$M_{40}^r(k) = \begin{cases} k + 58, & -58 \leq k \leq -54 \\ k + 57, & -52 \leq k \leq -26 \\ k + 56, & -24 \leq k \leq -12 \\ k + 55, & -10 \leq k \leq -2 \\ k + 52, & 2 \leq k \leq 10 \\ k + 51, & 12 \leq k \leq 24 \\ k + 50, & 26 \leq k \leq 52 \\ k + 49, & 54 \leq k \leq 58 \end{cases} \quad (22-51)$$

For an 80 MHz VHT transmission,

$$D_{k,80}^{(u)} = \begin{cases} 0, & k = 0, \pm 1, \pm 11, \pm 39, \pm 75, \pm 103 \\ d_{M_{80}^{(k)}}^{(u)}, & \text{otherwise} \end{cases} \quad (22-52)$$

$$M_{80}^r(k) = \begin{cases} k + 122, & -122 \leq k \leq -104 \\ k + 121, & -102 \leq k \leq -76 \\ k + 120, & -74 \leq k \leq -40 \\ k + 119, & -38 \leq k \leq -12 \\ k + 118, & -10 \leq k \leq -2 \\ k + 115, & 2 \leq k \leq 10 \\ k + 114, & 12 \leq k \leq 38 \\ k + 113, & 40 \leq k \leq 74 \\ k + 112, & 76 \leq k \leq 102 \\ k + 111, & 104 \leq k \leq 122 \end{cases} \quad (22-53)$$

For a 160 MHz VHT transmission,

$$D_{k,160}^{(u)} = \begin{cases} 0, & k = 0, \pm 1, \pm 2, \pm 3, \pm 4, \pm 5, \pm 25, \pm 53, \pm 89, \pm 117, \pm 127, \pm 128, \pm 129, \pm 139, \pm 167, \pm 203, \pm 231 \\ d_{M_{160}^r(k)}^{(u)}, & \text{otherwise} \end{cases} \quad (22-54)$$

$$M_{160}^r(k) = \begin{cases} k + 250, & -250 \leq k \leq -232 \\ k + 249, & -230 \leq k \leq -204 \\ k + 248, & -202 \leq k \leq -168 \\ k + 247, & -166 \leq k \leq -140 \\ k + 246, & -138 \leq k \leq -130 \\ k + 243, & -126 \leq k \leq -118 \\ k + 242, & -116 \leq k \leq -90 \\ k + 241, & -88 \leq k \leq -54 \\ k + 240, & -52 \leq k \leq -26 \\ k + 239, & -24 \leq k \leq -6 \\ k + 228, & 6 \leq k \leq 24 \\ k + 227, & 26 \leq k \leq 52 \\ k + 226, & 54 \leq k \leq 88 \\ k + 225, & 90 \leq k \leq 116 \\ k + 224, & 118 \leq k \leq 126 \\ k + 221, & 130 \leq k \leq 138 \\ k + 220, & 140 \leq k \leq 166 \\ k + 219, & 168 \leq k \leq 202 \\ k + 218, & 204 \leq k \leq 230 \\ k + 217, & 232 \leq k \leq 250 \end{cases} \quad (22-55)$$

For a noncontiguous 80+80 MHz VHT transmission, each frequency segment shall follow the 80 MHz VHT transmission format as specified in Equation (22-52) and Equation (22-53).

In Equation (22-48), Equation (22-50), Equation (22-52), and Equation (22-54), $d_k^{(u)}$ is the constellation point of VHT-SIG-B for user u (starting with 0) at subcarrier k (prior to multiplication by P_{VHTLTF}).

22.3.9 Transmission of NON_HT and HT PPDU with multiple transmit chains

22.3.9.1 Transmission of 20 MHz NON_HT PPDU with more than one transmit chain

A VHT STA that transmits a NON_HT PPDU shall apply the cyclic shifts defined in Table 22-10 to the preamble and Data field.

22.3.9.2 Transmission of HT PPDU with more than four transmit chains

A VHT STA that transmits an HT PPDU with FORMAT equal to HT_MF shall apply the cyclic shifts defined in Table 22-10 for the non-HT portion of the PPDU, including the HT-SIG field.

22.3.10 Data field

22.3.10.1 General

The number of OFDM symbols in the Data field is determined by the Length field in L-SIG (see Equation (22-24)), the preamble duration and the setting of the Short GI field in VHT-SIG-A (see 22.3.8.3.3).

When BCC encoding is used, the Data field shall consist of the SERVICE field, the PSDU, the PHY pad bits, and the tail bits ($N_{tail}N_{ES}$ bits for SU and $N_{tail}N_{ES,u}$ bits for each user u in MU). When LDPC encoding is used, the Data field shall consist of the SERVICE field, the PSDU, and the PHY pad bits. No tail bits are present when LDPC encoding is used.

The padding flow is as follows. The MAC delivers a PSDU that fills the available octets in the Data field of the PPDU for each user u . The PHY determines the number of pad bits to add and appends them to the PSDU. The number of pad bits added will always be 0 to 7 per user. When user u of a VHT MU PPDU uses BCC encoding, the number of pad bits is calculated using Equation (22-56). In the case of SU ignore u in Equation (22-56).

$$N_{PAD,u} = N_{SYM}N_{DBPS,u} - 8 \cdot \text{PSDU_LENGTH}_u - N_{service} - N_{tail}N_{ES,u} \quad (22-56)$$

where

PSDU_LENGTH_u is defined in 22.4.3

N_{SYM} is the number of symbols in the Data field and is given by Equation (22-111) for a VHT SU PPDU and by Equation (22-67) for a VHT MU PPDU

For an SU PPDU, if LDPC encoding is used then the PHY padding bits are calculated using Equation (22-57).

$$N_{PAD} = N_{SYM,init}N_{DBPS} - 8 \cdot \text{PSDU_LENGTH} - N_{service} \quad (22-57)$$

where

PSDU_LENGTH is defined in 22.4.3

$N_{SYM,init}$ is given by Equation (22-62)

For a VHT MU PPDU, if LDPC encoding is used for user u then the PHY padding bits are calculated using Equation (22-58).

$$N_{PAD,u} = N_{SYM_max_init} N_{DBPS,u} - 8 \cdot PSDU_LENGTH_u - N_{service} \tag{22-58}$$

where

$PSDU_LENGTH_u$ is defined in 22.4.3

$N_{SYM_max_init}$ is given by Equation (22-65)

The Data field of the VHT PPDU contains data for one or more users. For a VHT MU PPDU, the data processing, from scrambling to constellation mapping shall happen on a per-user basis. In the following subclauses, this process is described from a single user’s point of view.

22.3.10.2 SERVICE field

The SERVICE field is as shown in Table 22-16.

Table 22-16—SERVICE field

Bits	Field	Description
B0-B6	Scrambler Initialization	Set to 0
B7	Reserved	Set to 0
B8-B15	CRC	CRC calculated over VHT-SIG-B (excluding tail bits)

22.3.10.3 CRC calculation for VHT-SIG-B

The CRC calculation and insertion is illustrated in Figure 22-23.

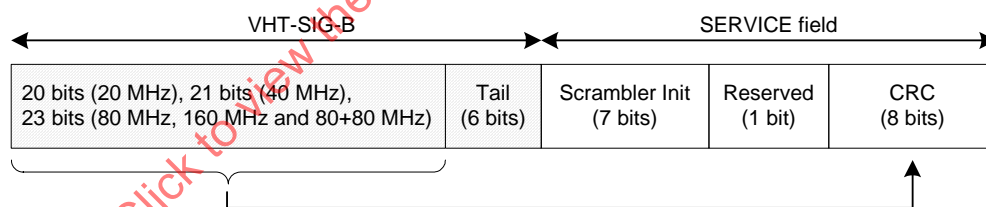

Figure 22-23—VHT-SIG-B and SERVICE field relationship

The value of the CRC field shall be the ones complement of Equation (22-59).

$$crc(D) = (M(D) \oplus I(D))D^8 \text{ mod } G(D) \tag{22-59}$$

where

$$M(D) = m_0 D^{N-1} + m_1 D^{N-2} + \dots + m_{N-2} D + m_{N-1}$$

N is the number of bits over which the CRC is generated; 20 for 20 MHz, 21 for 40 MHz, and 23 for 80 MHz/160 MHz/80+80 MHz

m_i is bit i of VHT-SIG-B

$$I(D) = \sum_{i=N-8}^{N-1} D^i \text{ are initialized values that are added modulo 2 to the first 8 bits of VHT-SIG-B}$$

$$G(D) = D^8 + D^2 + D + 1 \text{ is the CRC generating polynomial}$$

$$crc(D) = c_0D^7 + c_1D^6 + \dots + c_6D + c_7$$

Figure 20-8 shows the operation of the CRC. First, the shift register is reset to all ones. The bits are then passed through the XOR operation at the input. When the last bit has entered, the output is generated by shifting the bits out of the shift register, c_7 first, through an inverter.

As an example, if bits $\{m_0, \dots, m_{22}\}$ are given by $\{100110000000000000000011\}$, the CRC bits $\{c_7, \dots, c_0\}$ are $\{00011100\}$.

The CRC field is transmitted with c_7 first. Hence, c_7 is mapped to B8 of the SERVICE field, c_6 is mapped to B9, ..., and c_0 is mapped to B15 of the SERVICE field.

22.3.10.4 Scrambler

The SERVICE, PSDU, and PHY pad parts of the Data field shall be scrambled by the scrambler defined in 18.3.5.5. The Clause 18 TXVECTOR parameters CH_BANDWIDTH_IN_NON_HT and DYN_BANDWIDTH_IN_NON_HT are not present; therefore, the initial state of the scrambler is set to a pseudorandom nonzero seed. Different users in a VHT MU PPDU may use different pseudorandom nonzero seeds.

22.3.10.5 Coding

22.3.10.5.1 General

The Data field shall be encoded using either the binary convolutional code (BCC) defined in 22.3.10.5.2 and 22.3.10.5.3 or the low density parity check (LDPC) code defined in 22.3.10.5.4. The encoder is selected by the SU/MU[0] Coding, MU[1] Coding, MU[2] Coding, or MU[3] Coding field in VHT-SIG-A, as defined in 22.3.8.3.3. When BCC FEC encoding is used, the number of encoders is determined by rate-dependent parameters as defined in 22.5. The operation of the BCC FEC is described in 22.3.10.5.2 and 22.3.10.5.3. The operation of the LDPC coder is described in 22.3.10.5.4. Support for the reception of a BCC encoded Data field is mandatory.

22.3.10.5.2 BCC encoder parsing operation

If multiple encoders are used, the scrambled SERVICE, PSDU, and PHY pad bits are divided between the encoders by sending bits to different encoders in a round robin manner. Bit i to encoder j of user u , denoted $x_{i,u}^{(j)}$, is as specified in Equation (22-60).

$$x_{i,u}^{(j)} = \begin{cases} b_{N_{ES} \cdot i + j, u}; & 0 \leq i < N_{SYM} \frac{N_{DBPS,u}}{N_{ES,u}} - N_{tail}, \quad 0 \leq j \leq N_{ES,u} - 1 \\ 0; & N_{SYM} \frac{N_{DBPS,u}}{N_{ES,u}} - N_{tail} \leq i < N_{SYM} \frac{N_{DBPS,u}}{N_{ES,u}}, \quad 0 \leq j \leq N_{ES,u} - 1 \end{cases} \quad (22-60)$$

where

$b_{k,u}$ is bit k of the scrambled SERVICE, PSDU, and pad bits of user u

N_{SYM} is the number of symbols in the Data field and is given by Equation (22-111) for a VHT SU PDU and by Equation (22-67) for a VHT MU PDU

NOTE—Tail bits with value 0 are being appended to each FEC input sequence in Equation (22-60).

22.3.10.5.3 Binary convolutional coding and puncturing

The BCC encoder parser output sequences of user u $\{x_{i,u}^{(j)}\}$, $0 \leq i < N_{SYM}N_{DBPS,u}/N_{ES,u}$, $0 \leq j \leq N_{ES,u} - 1$ will each be encoded by a rate $R = 1/2$ convolutional encoder defined in 18.3.5.6. After encoding, the encoded data is punctured by the method defined in 18.3.5.6 (except for rate 5/6), to achieve the rate selected by the modulation and coding scheme. In the case that rate 5/6 coding is selected, the puncturing scheme will be same as described in 20.3.11.6.

22.3.10.5.4 LDPC coding

For a VHT SU PDU using LDPC coding to encode the Data field, the LDPC code and encoding process described in 20.3.11.7 (LDPC codes) shall be used with the following modifications. First, all bits in the Data field including the scrambled SERVICE, PSDU, and pad bits are encoded. Thus, N_{pld} for VHT PDUs shall be computed using Equation (22-61) instead of Equation (20-35).

$$N_{pld} = N_{SYM,init}N_{DBPS} \quad (22-61)$$

where

$N_{SYM,init}$ is given by Equation (22-62)

$$N_{SYM,init} = m_{STBC} \times \left\lceil \frac{8 \cdot APEP_LENGTH + N_{service}}{m_{STBC} \cdot N_{DBPS}} \right\rceil \quad (22-62)$$

where

m_{STBC} is equal to 2 when STBC is used, and 1 otherwise

APEP_LENGTH is the TXVECTOR parameter APEP_LENGTH

Following the calculation of N_{pld} , N_{avbits} shall be computed using Equation (22-63) instead of Equation (20-36).

$$N_{avbits} = N_{SYM,init}N_{CBPS} \quad (22-63)$$

In addition, if N_{SYM} computed in Equation (20-41) in step (d) of 20.3.11.7.5 (LDPC PDU encoding process) is greater than $N_{SYM,init}$, then the LDPC Extra OFDM Symbol field of VHT-SIG-A shall be set to 1. Otherwise, the LDPC Extra OFDM Symbol field of VHT-SIG-A shall be set to 0.

LDPC codes used in VHT MU PDUs shall also follow the definitions in 20.3.11.7 (LDPC codes). Refer to 22.3.10.5.5 for a description of the LDPC encoding process for VHT MU PDUs.

22.3.10.5.5 Encoding process for VHT MU PDUs

For a VHT MU PDU, first compute the initial number of OFDM symbols for each user using Equation (22-64).

$$N_{SYM_init,u} = \begin{cases} \left\lceil \frac{8 \cdot APEP_LENGTH_u + N_{service} + N_{tail} \cdot N_{ES,u}}{N_{DBPS,u}} \right\rceil & \text{when user } u \text{ uses BCC} \\ \left\lceil \frac{8 \cdot APEP_LENGTH_u + N_{service}}{N_{DBPS,u}} \right\rceil & \text{when user } u \text{ uses LDPC} \end{cases} \quad (22-64)$$

where

$APEP_LENGTH_u$ is the TXVECTOR parameter $APEP_LENGTH$ for user u

Based on the above equation, compute the largest initial number of symbols over all users using Equation (22-65).

$$N_{SYM_max_init} = \max_{u=0}^{N_{user}-1} \{N_{SYM_init,u}\} \quad (22-65)$$

Then, for each user u that uses LDPC in the VHT MU PPDU, the final number of symbols in the Data field ($N_{SYM,u}$) shall be computed as follows. First, perform step a) in 20.3.11.7.5 with the exception that N_{pld} is computed using Equation (22-66) instead of Equation (20-35).

$$N_{pld} = N_{SYM_max_init} N_{DBPS,u} \quad (22-66)$$

Then, perform steps b) through d) in 20.3.11.7.5 (LDPC PPDU encoding process) with N_{CBPS} and R replaced with $N_{CBPS,u}$ and R_u , respectively. $N_{SYM,u}$ for user u shall then be equal to the value of N_{SYM} obtained at the end of step d) using Equation (20-41).

The purpose of going through steps a) to d) in 20.3.11.7.5 (LDPC PPDU encoding process) in the above paragraph is to compute $N_{SYM,u}$. Thus, at this stage $N_{SYM,u}$ for each user may be calculated without actually encoding the data using LDPC.

For BCC users, $N_{SYM,u} = N_{SYM_init,u}$.

Then, compute the number of symbols in the Data field using Equation (22-67).

$$N_{SYM} = \max_{u=0}^{N_{user}-1} \{N_{SYM,u}\} \quad (22-67)$$

When constructing the Data field for user u encoded using LDPC code, the MAC follows the padding procedure described in 9.12.6 and delivers a PSDU that contains $PSDU_LENGTH_u$ octets (see 22.4.3). The PHY follows the padding procedure described in 22.3.10.1 to fill $N_{SYM_max_init}$ symbols, where $N_{SYM_max_init}$ is defined in Equation (22-65). Then, for each user, all bits in the Data field including the scrambled SERVICE, PSDU, and pad bits shall be encoded using the LDPC encoding process specified in 20.3.11.7.5 with the following modifications. First, N_{pld} shall be computed using Equation (22-66) instead of Equation (20-35). Also, replace N_{CBPS} and R with $N_{CBPS,u}$ and R_u , respectively. Next, step d) in 20.3.11.7.5 is replaced with step d) below:

- d) If N_{SYM} computed in Equation (22-67) is equal to $N_{SYM_max_init}$, then the number of bits to be punctured, N_{punc} , from the codewords after encoding is computed as shown in Equation (20-38).

If N_{SYM} computed in Equation (22-67) is greater than $N_{SYM_max_init}$, then the number of bits to be punctured, N_{punc} , from the codewords after encoding is computed using Equation (20-39) and Equation (20-40). Note also that N_{avbits} has now been updated in Equation (20-39) in this case.

The punctured bits shall be equally distributed over all N_{CW} codewords with the first

$\text{rem}(N_{punc}, N_{CW})$ codewords punctured 1 bit more than the remaining codewords. Define $N_{ppcw} = \lfloor N_{punc} / N_{CW} \rfloor$. When $N_{ppcw} > 0$, the puncturing is performed by discarding parity bits $P_{n-k-N_{ppcw}-1}, \dots, P_{n-k-1}$ of the first $\text{rem}(N_{punc}, N_{CW})$ codewords and discarding parity bits $P_{n-k-N_{ppcw}}, \dots, P_{n-k-1}$ of the remaining codewords after encoding.

When constructing the Data field for users encoded using BCC, the MAC follows the padding procedure described in 9.12.6 and delivers a PSDU that contains PSDU_LENGTH_u octets. The PHY follows the padding procedure described in 22.3.10.1 to fill up N_{SYM} symbols computed in Equation (22-67). Then, for each user, all bits in the Data field including the scrambled SERVICE, PSDU, and pad bits shall be encoded using the BCC encoding process specified in 22.3.10.5.2 and 22.3.10.5.3. Note that this process ensures that the BCC tail bits are placed at the very end of the PPDU.

In addition, if N_{SYM} computed in Equation (22-67) is greater than $N_{SYM_max_init}$ computed in Equation (22-65), then the LDPC Extra OFDM Symbol field of VHT-SIG-A2 shall be set to 1. Otherwise, the LDPC Extra OFDM Symbol field of VHT-SIG-A2 shall be set to 0.

22.3.10.6 Stream parser

After coding and puncturing, the data bit streams at the output of the FEC encoders are processed in groups of N_{CBPS} bits. Each of these groups is re-arranged into N_{SS} blocks of N_{CBPSS} bits ($N_{SS,u}$ blocks of $N_{CBPSS,u}$ bits in the case of an MU transmission). This operation is referred to as “stream parsing” and is described in this subclause.

The description is given in terms of an SU transmission. For MU transmissions, the rearrangements are carried out in the same way per user.

The number of bits assigned to a single axis (real or imaginary) of a constellation point in a spatial stream is denoted by Equation (22-68).

$$s = \max \left\{ 1, \frac{N_{BPSCS}}{2} \right\} \quad (22-68)$$

The sum of these over all streams is $S = N_{SS} \cdot s$

Consecutive blocks of s bits are assigned to different spatial streams in a round robin fashion.

Let

$$N_{\text{Block}} = \left\lfloor \frac{N_{CBPS}}{N_{ES} \cdot S} \right\rfloor \quad (22-69)$$

and

$$M = \frac{N_{CBPS} - N_{\text{Block}} \cdot N_{ES} \cdot S}{s \cdot N_{ES}} \quad (22-70)$$

For the first $N_{\text{Block}} \cdot N_{ES} \cdot S$ bits of each OFDM symbol, S bits from the output of first encoder are divided among all spatial streams, s bits per stream. Then, S bits from the output of next encoder are used, and so on. If N_{CBPS} is greater than $N_{\text{Block}} \cdot N_{ES} \cdot S$, then for the last $N_{CBPS} - N_{\text{Block}} \cdot N_{ES} \cdot S$ bits of each OFDM symbol, $M \cdot s$ bits from the output of the first encoder are fed into spatial streams 1 through M (s bits per

spatial stream), and then $M \cdot s$ bits from the output of the next encoder are used for spatial stream $M + 1$ through $[(2M - 1) \bmod N_{SS}] + 1$, and so on, where $z \bmod t$ is the remainder resulting from the division of integer z by integer t .

The following equations are an equivalent description to the above procedure. Bit i at the output of encoder j is assigned to input bit k of spatial stream i_{SS} where

$$j = \begin{cases} \left\lfloor \frac{k}{s} \right\rfloor \bmod N_{ES}, & k = 0, 1, \dots, N_{\text{Block}} \cdot N_{ES} \cdot s - 1 \\ \left\lfloor \frac{L}{M} \right\rfloor, & k = N_{\text{Block}} \cdot N_{ES} \cdot s, \dots, N_{CBPSS} - 1 \end{cases} \quad (22-71)$$

and

$$i = \begin{cases} (i_{SS} - 1)s + S \cdot \left\lfloor \frac{k}{N_{ES} \cdot s} \right\rfloor + k \bmod s, & k = 0, 1, \dots, N_{\text{Block}} \cdot N_{ES} \cdot s - 1 \\ (L \bmod M) \cdot s + N_{\text{Block}} \cdot S + k \bmod s, & k = N_{\text{Block}} \cdot N_{ES} \cdot s, \dots, N_{CBPSS} - 1 \end{cases} \quad (22-72)$$

where

$$i_{SS} = 1, 2, \dots, N_{SS}$$

$$i = 0, 1, \dots, N_{CBPS}/N_{ES} - 1$$

$$j = 0, 1, \dots, N_{ES} - 1$$

$$k = 0, 1, \dots, N_{CBPSS} - 1$$

$$L = \left\lfloor \frac{k'}{s} \right\rfloor N_{SS} + (i_{SS} - 1)$$

$$k' = k - N_{\text{Block}} \cdot N_{ES} \cdot s$$

$\lfloor x \rfloor$ is the largest integer less than or equal to x

$z \bmod t$ is the remainder resulting from the division of integer z by integer t

NOTE— N_{CBPS} is greater than $N_{\text{Block}} \cdot N_{ES} \cdot s$ in only the following cases:

- 160 MHz and 80+80 MHz, $N_{SS} = 5$, VHT-MCS = 5
- 160 MHz and 80+80 MHz, $N_{SS} = 5$, VHT-MCS = 6
- 160 MHz and 80+80 MHz, $N_{SS} = 7$, VHT-MCS = 5
- 160 MHz and 80+80 MHz, $N_{SS} = 7$, VHT-MCS = 6

22.3.10.7 Segment parser

The description in this subclause is given in terms of an SU transmission. For MU transmissions, the rearrangements are carried out in the same way per user.

For a contiguous 160 MHz or a noncontiguous 80+80 MHz transmission, the output bits of each stream parser are first divided into blocks of N_{CBPSS} bits ($N_{CBPSS,u}$ bits in the case of an MU transmission). Then, each block is further divided into two frequency subblocks of $N_{CBPSS}/2$ bits as shown in Equation (22-73).

$$y_{k,l} = x_{2s \cdot N_{ES} \left\lfloor \frac{k}{s \cdot N_{ES}} \right\rfloor + l \cdot s \cdot N_{ES} + k \bmod (s \cdot N_{ES})}, \quad k = 0, 1, \dots, \frac{N_{CBPSS}}{2} - 1 \quad (22-73)$$

where

- $\lfloor z \rfloor$ is the largest integer less than or equal to z
- $z \bmod t$ is the remainder resulting from the division of integer z by integer t
- x_m is the m th bit of a block of N_{CBPSS} bits, $m=0$ to $N_{CBPSS}-1$
- l is the frequency subblock index, $l = 0, 1$
- $y_{k,l}$ is bit k of the frequency subblock l
- s is defined in Equation (22-68)

If N_{CBPSS} is not divisible by $2s \cdot N_{ES}$, then apply the segment parsing method described in Equation (22-73) for $\lfloor N_{CBPSS}/(2s \cdot N_{ES}) \rfloor$ sets of $2s \cdot N_{ES}$ segment parser input bits. At this point, each stream parser output has $2s \cdot N_{res}$ ($N_{res} = \frac{N_{CBPSS} \bmod (2s \cdot N_{ES})}{2s} < N_{ES}$, integer) residue bits. Then, the residue bits are divided into subsets of s bits, with each subset being assigned to different subblock ($l = 0, 1$) in a round robin fashion. The first s bits are assigned to the subblock with index $l = 0$. Repeat N_{res} times (until all bits are distributed to the two subblocks). That is, if N_{CBPSS} is not divisible by $2s \cdot N_{ES}$, each block is further divided into two subblocks of $N_{CBPSS}/2$ bits as shown in Equation (22-74).

$$y_{k,l} = \begin{cases} x_{2s \cdot N_{ES} \left\lfloor \frac{k}{s \cdot N_{ES}} \right\rfloor + l \cdot s \cdot N_{ES} + k \bmod (s \cdot N_{ES})}, & k = 0, 1, \dots, \lfloor N_{CBPSS}/(2s \cdot N_{ES}) \rfloor \cdot s \cdot N_{ES} - 1 \\ x_{2s \cdot N_{ES} \left\lfloor \frac{k}{s \cdot N_{ES}} \right\rfloor + 2s \cdot \left\lfloor \frac{k \bmod (s \cdot N_{ES})}{s} \right\rfloor + l \cdot s + k \bmod s}, & k = \lfloor N_{CBPSS}/(2s \cdot N_{ES}) \rfloor \cdot s \cdot N_{ES}, \dots, \frac{N_{CBPSS}}{2} - 1 \end{cases} \quad (22-74)$$

Segment parser is bypassed for a 20 MHz, 40 MHz, or 80 MHz VHT PPDU transmission, i.e., as specified in Equation (22-75).

$$y_{k,l} = x_k, \quad k = 0, 1, \dots, N_{CBPSS} \quad (22-75)$$

where

- l is the frequency subblock index. $l = 0$ for a 20, 40 or 80 MHz VHT PPDU transmission.
- $y_{k,l}$ is bit k of the frequency subblock l
- x_m is bit m of a block of N_{CBPSS} bits, $m = 0$ to $N_{CBPSS}-1$

22.3.10.8 BCC interleaver

For ease of explanation, the operation of the interleaver is described for the SU case. For user u of an MU transmission, the interleaver operates in the same way on the output bits for the user from the stream parser by replacing N_{SS} , N_{CBPSS} , N_{CBPSSl} , and N_{BPSCS} with $N_{SS,u}$, $N_{CBPSS,u}$, $N_{CBPSSl,u}$, and $N_{BPSCS,u}$ respectively.

That is, the operation of the interleaver is the same as if the transmission were an SU one, consisting of bits from only that user.

This subclause describes the interleaver used in the case of BCC encoding. The interleaver described in this subclause shall be bypassed in the case of LDPC encoding.

For a 20 MHz, 40 MHz, or 80 MHz VHT PPDU transmission, the bits at the output of the stream parser are processed in groups of N_{CBPS} bits. Each of these groups is divided into N_{SS} blocks of N_{CBPSS} bits, and each block shall be interleaved by an interleaver based on the Clause 18 interleaver. For a contiguous 160 MHz or a noncontiguous 80+80 MHz VHT PPDU transmission, each frequency subblock of $N_{CBPSS}/2$ output bits from the segment parser is interleaved by the interleaver for 80 MHz defined in this subclause. This interleaver, which is based on entering the data in rows, and reading it out in columns, has a different number of columns N_{COL} and rows N_{ROW} for different bandwidths. The values of N_{COL} and N_{ROW} are given in Table 22-17.

Table 22-17—Number of rows and columns in the interleaver

Parameter	20 MHz	40 MHz	80 MHz
N_{COL}	13	18	26
N_{ROW}	$4 \times N_{BPSCS}$	$6 \times N_{BPSCS}$	$9 \times N_{BPSCS}$
$N_{ROT} (N_{SS} \leq 4)$	11	29	58
$N_{ROT} (N_{SS} > 4)$	6	13	28

After the operations based on the Clause 18 interleaver have been applied and if more than one spatial stream exists, a third operation called frequency rotation is applied to the additional spatial streams. The parameter for the frequency rotation is N_{ROT} . The values of N_{ROT} are given in Table 22-17.

An additional parameter is the spatial stream index $i_{SS} = 1, 2, \dots, N_{SS}$. The output of the third operation is a function of the spatial stream index.

The interleaving is defined using three permutations. The first permutation is given by the rule shown in Equation (22-76).

$$i = N_{ROW}(k \bmod N_{COL}) + \left\lfloor \frac{k}{N_{COL}} \right\rfloor, k = 0, 1, \dots, N_{CBPSS} - 1 \quad (22-76)$$

where

$\lfloor x \rfloor$ is the largest integer less than or equal to x

The second permutation is defined by the rule shown in Equation (22-77).

$$j = s \left\lfloor \frac{i}{s} \right\rfloor + \left(i + N_{CBPSS} - \left\lfloor \frac{N_{COL} \cdot i}{N_{CBPSS}} \right\rfloor \right) \bmod s, \quad i = 0, 1, \dots, N_{CBPSS} - 1 \quad (22-77)$$

where

s is defined in Equation (22-68)

If $2 \leq N_{SS} \leq 4$, a frequency rotation is applied to the output of the second permutation as shown in Equation (22-78).

$$r = \left\{ j - \left[(2(i_{SS} - 1)) \bmod 3 + 3 \left\lfloor \frac{i_{SS} - 1}{3} \right\rfloor \right] \cdot N_{ROT} \cdot N_{BPSCS} \right\} \bmod N_{CBPSSI} \quad (22-78)$$

$$j = 0, 1, \dots, N_{CBPSSI} - 1$$

where

$i_{SS} = 1, 2, \dots, N_{SS}$ is the spatial steam index on which this interleaver is operating

If $N_{SS} > 4$, a frequency rotation is applied to the output of the second permutation as shown in Equation (22-79).

$$r = \{j - J(i_{SS}) \cdot N_{ROT} \cdot N_{BPSCS}\} \bmod N_{CBPSSI}, j = 0, 1, \dots, N_{CBPSSI} - 1 \quad (22-79)$$

where

$i_{SS} = 1, 2, \dots, N_{SS}$ is the spatial steam index on which this interleaver is operating, and $J(i_{SS})$ is an integer as defined in Table 22-18.

Table 22-18— $J(i_{SS})$ values

i_{SS}	$J(i_{SS})$
1	0
2	5
3	2
4	7
5	3
6	6
7	1
8	4

The deinterleaver uses the following three operations to perform the inverse permutations. Let r denote the index of the bit in the received block (per spatial stream). The first operation reverses the third (frequency rotation) permutation of the interleaver. When $N_{SS} = 1$, this reversal is performed by $j = r$ ($r = 0, 1, \dots, N_{CBPSSI} - 1$). When $2 \leq N_{SS} \leq 4$, this reversal is performed by as shown in Equation (22-80).

$$j = \left\{ r + \left[(2(i_{SS} - 1)) \bmod 3 + 3 \left\lfloor \frac{i_{SS} - 1}{3} \right\rfloor \right] \cdot N_{ROT} \cdot N_{BPSCS} \right\} \bmod N_{CBPSSI} \quad (22-80)$$

$$r = 0, 1, \dots, N_{CBPSSI} - 1$$

When $N_{SS} > 4$, this reversal is performed by Equation (22-81).

$$j = \{ r + J(i_{SS}) \cdot N_{ROT} \cdot N_{BPSCS} \} \bmod N_{CBPSSI} \quad r = 0, 1, \dots, N_{CBPSSI} - 1 \quad (22-81)$$

where

$J(i_{SS})$ is defined in Table 22-18

The second operation defined by Equation (22-82) reverses the second permutation in the interleaver.

$$i = s \left\lfloor \frac{j}{s} \right\rfloor + \left(j + \left\lfloor \frac{N_{COL} \cdot j}{N_{CBPSSI}} \right\rfloor \right) \bmod s, \quad j = 0, 1, \dots, N_{CBPSSI} - 1 \quad (22-82)$$

where

s is defined in Equation (22-68)

The third operation defined in Equation (22-83) reversed the first permutation of the interleaver.

$$k = N_{COL} \cdot i - (N_{CBPSSI} - 1) \left\lfloor \frac{i}{N_{ROW}} \right\rfloor, \quad i = 0, 1, \dots, N_{CBPSSI} - 1 \quad (22-83)$$

22.3.10.9 Constellation mapping

22.3.10.9.1 General

The mapping between bits at the output of the interleaver and complex constellation points for BPSK, QPSK, 16-QAM, and 64-QAM follows the rules defined in 18.3.5.8. For 256-QAM, the mapping is shown in Figure 22-24, Figure 22-25, Figure 22-26, and Figure 22-27.

The bit-string convention in Figure 22-24, Figure 22-25, Figure 22-26, and Figure 22-27 follows the bit-string convention outlined in 18.3.5.8.

The streams of complex numbers in frequency subblock l for user u are denoted

$$d_{k,i,n,l,u}^l; \quad k = 0, 1, \dots, N_{SD} - 1; \quad i = 1, \dots, N_{SS,u}; \quad n = 0, 1, \dots, N_{SYM} - 1; \quad (22-84)$$

$$l = 0 \text{ for 20 MHz, 40 MHz, and 80 MHz;} \\ l = 0, 1 \text{ for 160 MHz and 80+80 MHz;} \\ u = 0, \dots, N_{user} - 1$$

The normalization factor, K_{MOD} , for 256-QAM is $1/\sqrt{170}$.

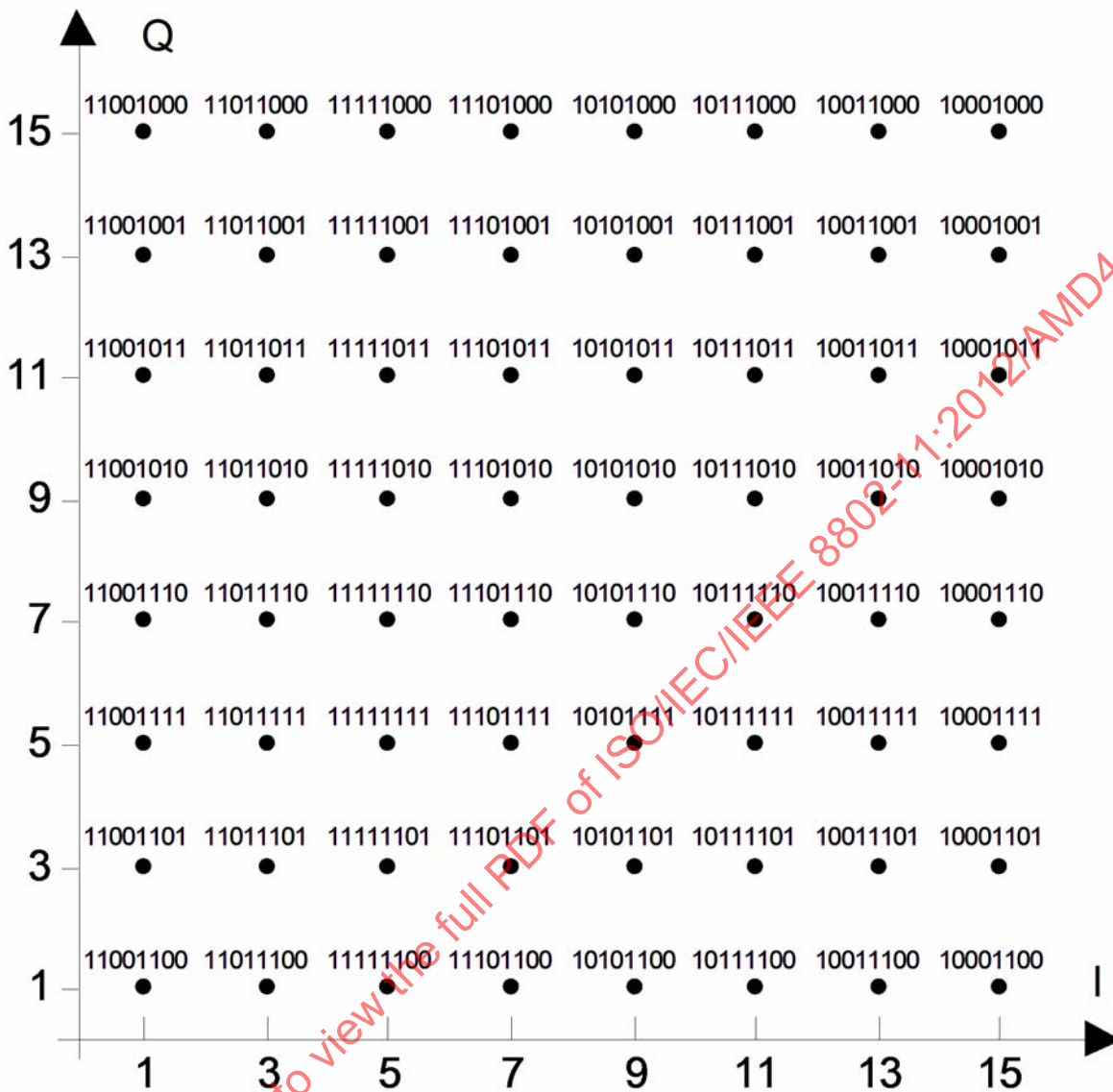

Figure 22-24—Constellation bit encoding for 256-QAM (1st quadrant)

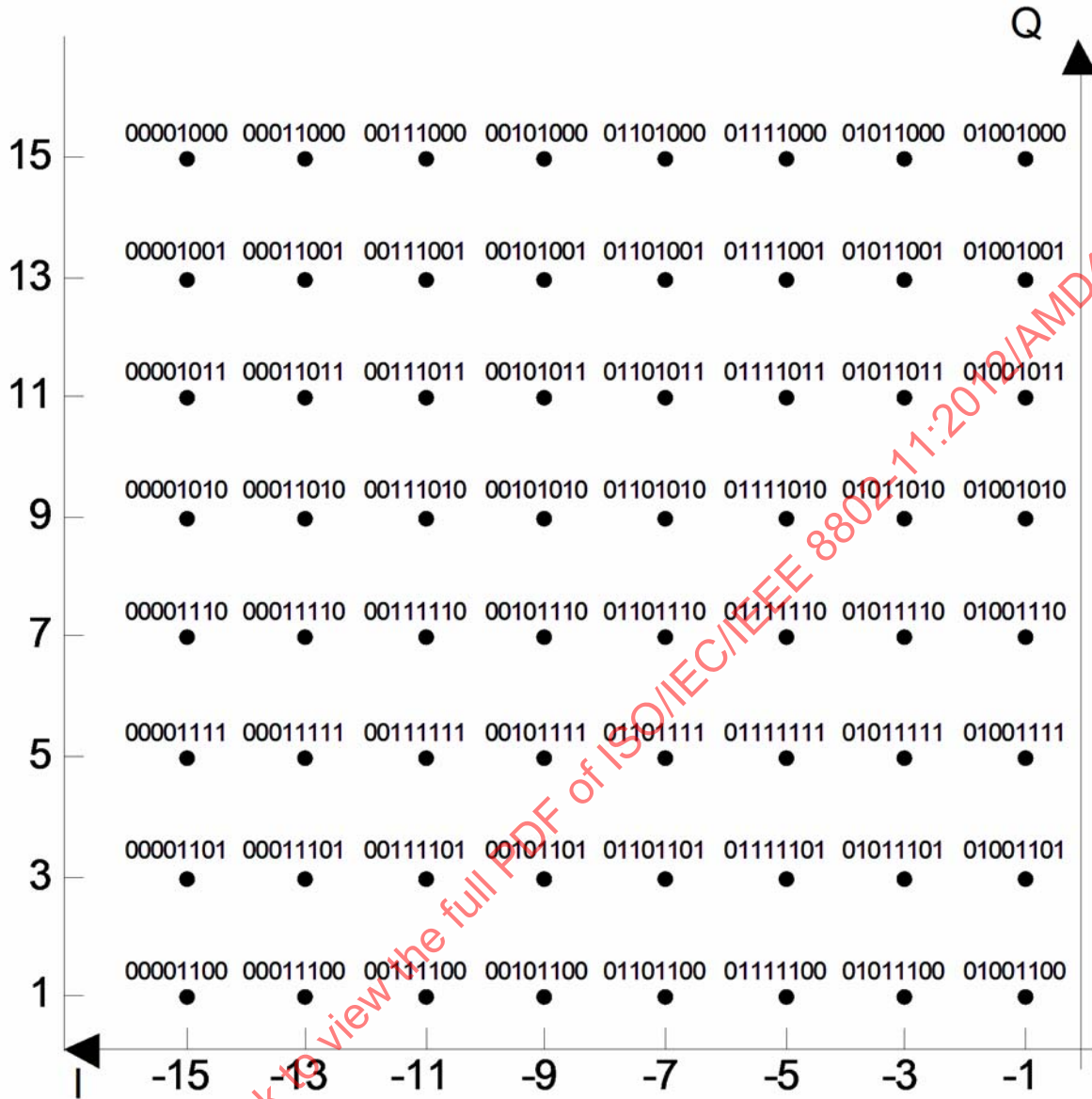

Figure 22-25—Constellation bit encoding for 256-QAM (2nd quadrant)

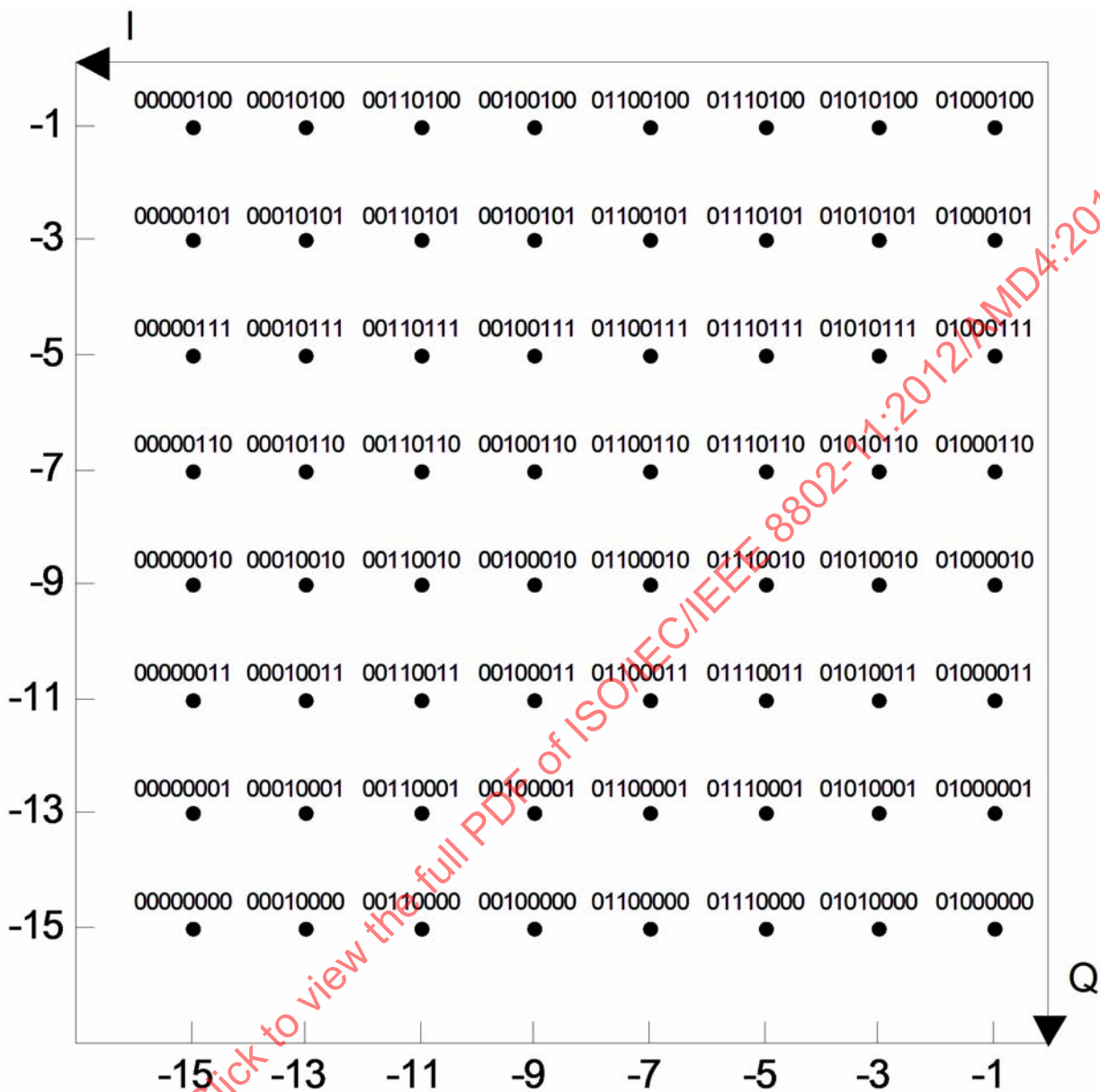

Figure 22-26—Constellation bit encoding for 256-QAM (3rd quadrant)

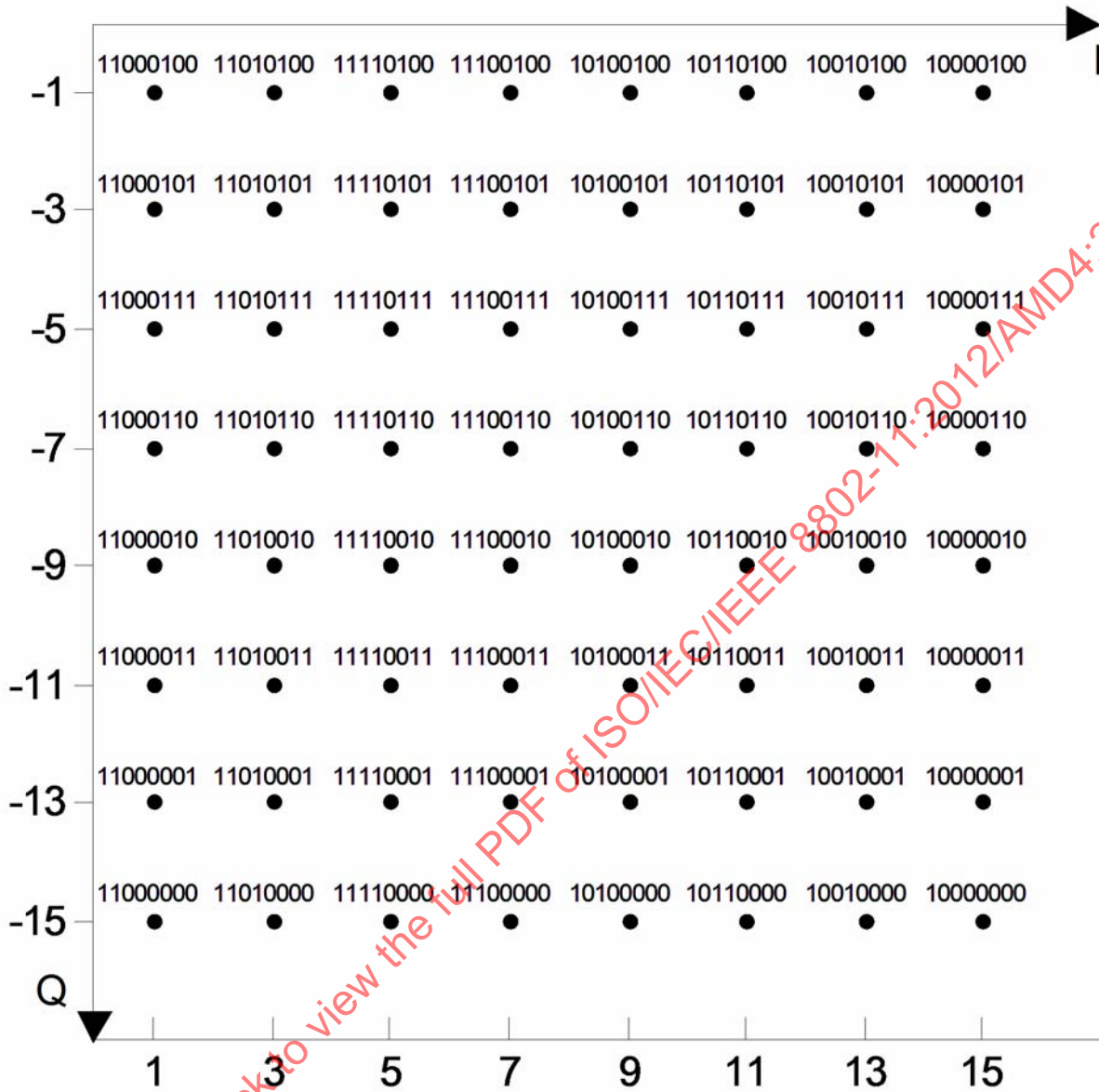

Figure 22-27—Constellation bit encoding for 256-QAM (4th quadrant)

22.3.10.9.2 LDPC tone mapping

The LDPC tone mapping shall be performed on all LDPC encoded streams as described in this subclause and using an LDPC tone-mapping distance parameter D_{TM} . D_{TM} is constant for each bandwidth and its value for different bandwidths is given in Table 22-19. LDPC tone mapping shall not be performed on streams that are encoded using BCC.

Table 22-19—LDPC tone mapping distance for each bandwidth

Parameter	20 MHz	40 MHz	80 MHz	160 MHz, 80+80 MHz
D_{TM}	4	6	9	9

For a 20 MHz, 40 MHz, and 80 MHz VHT PPDU transmission, the LDPC tone mapping for LDPC-coded streams corresponding to user u is done by permuting the stream of complex numbers generated by the constellation mappers (see Equation (22-84)) to obtain

$$d''_{t(k), i, n, l, u} = d'_{k, i, n, l, u}; \quad k = 0, 1, \dots, N_{SD} - 1; \quad i = 1, \dots, N_{SS, u}; \quad n = 0, 1, \dots, N_{SYM} - 1; \quad (22-85)$$

$$l = 0 \text{ for 20 MHz, 40 MHz, and 80 MHz;} \\ l = 0, 1 \text{ for 160 MHz and 80+80 MHz;} \\ u = 0, \dots, N_{user} - 1$$

where

$$t(k) = \begin{cases} D_{TM} \left(k \bmod \frac{N_{SD}}{D_{TM}} \right) + \left\lfloor \frac{k \cdot D_{TM}}{N_{SD}} \right\rfloor, & \text{for 20 MHz, 40 MHz, 80 MHz, and 80+80 MHz} \\ D_{TM} \left(k \bmod \frac{N_{SD}/2}{D_{TM}} \right) + \left\lfloor \frac{k \cdot D_{TM}}{N_{SD}/2} \right\rfloor, & \text{for 160 MHz} \end{cases} \quad (22-86)$$

As a result of the LDPC tone mapping operation above, each two consecutively generated complex constellation numbers $d'_{k, i, n, l, u}$ and $d'_{k+1, i, n, l, u}$ will be transmitted on two data tones that are separated by at least $D_{TM} - 1$ from other data tones. Note that the operation above is equivalent to block-interleaving the complex numbers $d'_{0, i, n, l, u}, \dots, d'_{N_{SD}-1, i, n, l, u}$ for each i, n , and u using a matrix with D_{TM} rows and N_{SD}/D_{TM} (for 20 MHz, 40 MHz, 80 MHz, or 80+80 MHz) or $\frac{N_{SD}}{2 \cdot D_{TM}}$ (for 160 MHz) columns, where $d'_{0, i, n, l, u}, \dots, d'_{N_{SD}-1, i, n, l, u}$ are written row-wise into the matrix, and $d''_{0, i, n, l, u}, \dots, d''_{N_{SD}-1, i, n, l, u}$ are read column-wise from the matrix.

NOTE—LDPC tone mapping is performed separately for the upper and lower 80 MHz segments of a 160 MHz of 80+80 MHz transmission as indicated by the frequency subblock index l in Equation (22-85) and Equation (22-86).

Since LDPC tone mapping is not performed on BCC-coded streams, for BCC-coded streams, the following applies:

$$d''_{k, i, n, l, u} = d'_{k, i, n, l, u}; \quad k = 0, 1, \dots, N_{SD} - 1; \quad i = 1, \dots, N_{SS, u}; \quad n = 0, 1, \dots, N_{SYM} - 1; \quad (22-87)$$

$$l = 0 \text{ for 20 MHz, 40 MHz, and 80 MHz;} \\ l = 0, 1 \text{ for 160 MHz and 80+80 MHz;} \\ u = 0, \dots, N_{user} - 1$$

22.3.10.9.3 Segment deparser

For a 160 MHz VHT PPDU transmission, the two frequency subblocks at the output of the LDPC tone mapper for LDPC or constellation mapper for BCC are combined into one frequency segment as shown in Equation (22-88).

$$d_{k,i,n,u}^{(i_{seg})} = \begin{cases} d''_{k,i,n,0,u}, & \text{if } 0 \leq k \leq \frac{N_{SD}}{2} - 1 \\ d''_{k-N_{SD}/2,i,n,1,u}, & \text{if } \frac{N_{SD}}{2} \leq k \leq N_{SD} - 1 \end{cases}, \quad i_{seg} = 0 \quad (22-88)$$

For a 20 MHz, 40 MHz, or 80 MHz VHT PPDU transmission, the segment deparsing is not performed. Hence,

$$d_{k,i,n,u}^{(i_{seg})} = d''_{k,i,n,0,u}, \quad 0 \leq k \leq N_{SD} - 1, \quad i_{seg} = 0 \quad (22-89)$$

For an 80+80 MHz VHT PPDU transmission, the segment deparsing is not performed. Hence,

$$d_{k,i,n,u}^{(i_{seg})} = d''_{k,i,n,i_{seg},u}, \quad 0 \leq k \leq N_{SD} - 1, \quad i_{seg} = 0, 1 \quad (22-90)$$

22.3.10.9.4 Space-time block coding

This subclause defines a set of optional robust transmission techniques that are applicable only when using STBC coding for VHT SU PPDUs. In this case, $N_{SS,0}$ spatial streams are mapped to $N_{STS,0}$ space-time streams. These techniques are based on STBC. When the VHT-SIG-A STBC field is 1, a symbol operation shall occur between the constellation mapper and the spatial mapper as defined in this subclause. STBC shall not be applied in a VHT MU PPDU. Hence, the user subscript u is 0 in this subclause.

If STBC is applied, the stream of complex numbers, $d_{k,i,n,0}^{(i_{seg})}$; $k = 0, \dots, N_{SD} - 1$; $i = 1, \dots, N_{SS,0}$; $n = 0, \dots, N_{SYM} - 1$, generated by the segment deparser, is the input to the STBC encoder, which produces as output the stream of complex numbers $\tilde{d}_{k,i_{STS},n,0}^{(i_{seg})}$; $k = 0, \dots, N_{SD} - 1$; $i_{STS} = 1, \dots, N_{STS,0}$; $n = 0, \dots, N_{SYM} - 1$. For given values of k and i , STBC processing operates on the complex modulation symbols in sequential pairs of OFDM symbols so that the value of $\tilde{d}_{k,2i-1,2m,0}^{(i_{seg})}$ and $\tilde{d}_{k,2i,2m,0}^{(i_{seg})}$ depend on $d_{k,i,2m,0}^{(i_{seg})}$ and $d_{k,i,2m+1,0}^{(i_{seg})}$. Also, $\tilde{d}_{k,2i-1,2m+1,0}^{(i_{seg})}$ and $\tilde{d}_{k,2i,2m+1,0}^{(i_{seg})}$ depend on $d_{k,i,2m,0}^{(i_{seg})}$ and $d_{k,i,2m+1,0}^{(i_{seg})}$. This is defined in Table 22-20. Note that the segment index i_{seg} is omitted in Table 22-20 for simplicity.

Table 22-20—Constellation mapper output to spatial mapper input for STBC

N_{STS}	N_{SS}	i_{STS}	$\tilde{d}_{k,i_{STS},2m,0}$	$\tilde{d}_{k,i_{STS},2m+1,0}$
2	1	1	$d_{k,1,2m,0}$	$d_{k,1,2m+1,0}$
		2	$-d_{k,1,2m+1,0}^*$	$d_{k,1,2m,0}^*$

Table 22-20—Constellation mapper output to spatial mapper input for STBC (continued)

N_{STS}	N_{SS}	i_{STS}	$\tilde{d}_{k, i_{STS}, 2m, 0}$	$\tilde{d}_{k, i_{STS}, 2m+1, 0}$
4	2	1	$d_{k, 1, 2m, 0}$	$d_{k, 1, 2m+1, 0}$
		2	$-d_{k, 1, 2m+1, 0}^*$	$d_{k, 1, 2m, 0}^*$
		3	$d_{k, 2, 2m, 0}$	$d_{k, 2, 2m+1, 0}$
		4	$-d_{k, 2, 2m+1, 0}^*$	$d_{k, 2, 2m, 0}^*$
6	3	1	$d_{k, 1, 2m, 0}$	$d_{k, 1, 2m+1, 0}$
		2	$-d_{k, 1, 2m+1, 0}^*$	$d_{k, 1, 2m, 0}^*$
		3	$d_{k, 2, 2m, 0}$	$d_{k, 2, 2m+1, 0}$
		4	$-d_{k, 2, 2m+1, 0}^*$	$d_{k, 2, 2m, 0}^*$
		5	$d_{k, 3, 2m, 0}$	$d_{k, 3, 2m+1, 0}$
		6	$-d_{k, 3, 2m+1, 0}^*$	$d_{k, 3, 2m, 0}^*$
8	4	1	$d_{k, 1, 2m, 0}$	$d_{k, 1, 2m+1, 0}$
		2	$-d_{k, 1, 2m+1, 0}^*$	$d_{k, 1, 2m, 0}^*$
		3	$d_{k, 2, 2m, 0}$	$d_{k, 2, 2m+1, 0}$
		4	$-d_{k, 2, 2m+1, 0}^*$	$d_{k, 2, 2m, 0}^*$
		5	$d_{k, 3, 2m, 0}$	$d_{k, 3, 2m+1, 0}$
		6	$-d_{k, 3, 2m+1, 0}^*$	$d_{k, 3, 2m, 0}^*$
		7	$d_{k, 4, 2m, 0}$	$d_{k, 4, 2m+1, 0}$
		8	$-d_{k, 4, 2m+1, 0}^*$	$d_{k, 4, 2m, 0}^*$

If STBC is not applied, $\tilde{d}_{k, i, n, 0}^{(i_{seg})} = d_{k, i, n, 0}^{(i_{seg})}$ and $N_{STS, 0} = N_{SS, 0}$.

NOTE—When STBC is applied, an odd number of space-time streams is not allowed, and $N_{STS, 0} = 2N_{SS, 0}$.

22.3.10.10 Pilot subcarriers

For a 20 MHz transmission, four pilot tones shall be inserted in subcarriers $k \in \{-21, -7, 7, 21\}$. The pilot mapping P_n^k for subcarrier k for symbol n shall be as specified in Equation (22-91).

$$P_n^{\{-21, -7, 7, 21\}} = \{\Psi_{1, n \bmod 4}^{(1)}, \Psi_{1, (n+1) \bmod 4}^{(1)}, \Psi_{1, (n+2) \bmod 4}^{(1)}, \Psi_{1, (n+3) \bmod 4}^{(1)}\}$$

$$P_n^{k \notin \{-21, -7, 7, 21\}} = 0$$
(22-91)

where

$\Psi_{1, m}^{(1)}$ is given by the $N_{STS} = 1$ row of Table 20-19

For a 40 MHz transmission, six pilot tones shall be inserted in subcarriers $-53, -25, -11, 11, 25,$ and 53 . The pilot mapping P_n^k for subcarrier k for symbol n shall be as specified in Equation (22-92).

$$P_n^{\{-53, -25, -11, 11, 25, 53\}} = \{\Psi_{1, n \bmod 6}^{(1)}, \Psi_{1, (n+1) \bmod 6}^{(1)}, \dots, \Psi_{1, (n+5) \bmod 6}^{(1)}\}$$

$$P_n^{k \notin \{-53, -25, -11, 11, 25, 53\}} = 0$$
(22-92)

where

$\Psi_{1, m}^{(1)}$ is given by the $N_{STS} = 1$ row of Table 20-20

For an 80 MHz transmission, eight pilot tones shall be inserted in subcarriers $-103, -75, -39, -11, 11, 39,$ $75,$ and 103 . The pilot mapping P_n^k for subcarrier k for symbol n shall be as specified in Equation (22-93).

$$P_n^{\{-103, -75, -39, -11, 11, 39, 75, 103\}} = \{\Psi_{n \bmod 8}, \Psi_{(n+1) \bmod 8}, \dots, \Psi_{(n+7) \bmod 8}\}$$

$$P_n^{k \notin \{-103, -75, -39, -11, 11, 39, 75, 103\}} = 0$$
(22-93)

where

Ψ_m is defined in Table 22-21

Table 22-21—Pilot values for 80 MHz transmission

Ψ_0	Ψ_1	Ψ_2	Ψ_3	Ψ_4	Ψ_5	Ψ_6	Ψ_7
1	1	1	-1	-1	1	1	1

For a 160 MHz transmission, the 80 MHz pilot mapping is replicated in the two 80 MHz subchannels of the 160 MHz transmission. Specifically, 16 pilot tones shall be inserted in subcarriers $-231, -203, -167, -139, -117, -89, -53, -25, 25, 53, 89, 117, 139, 167, 203,$ and 231 . The pilot mapping P_n^k for subcarrier k for symbol n shall be as specified in Equation (22-94).

$$P_n^{\{-231, -203, -167, -139, -117, -89, -53, -25, 25, 53, 89, 117, 139, 167, 203, 231\}}$$

$$= \{\Psi_{n \bmod 8}, \Psi_{(n+1) \bmod 8}, \Psi_{(n+2) \bmod 8}, \Psi_{(n+3) \bmod 8}, \Psi_{(n+4) \bmod 8}, \Psi_{(n+5) \bmod 8}, \Psi_{(n+6) \bmod 8}, \Psi_{(n+7) \bmod 8},$$

$$\Psi_{n \bmod 8}, \Psi_{(n+1) \bmod 8}, \Psi_{(n+2) \bmod 8}, \Psi_{(n+3) \bmod 8}, \Psi_{(n+4) \bmod 8}, \Psi_{(n+5) \bmod 8}, \Psi_{(n+6) \bmod 8}, \Psi_{(n+7) \bmod 8}\}$$

$$P_n^{k \notin \{-231, -203, -167, -139, -117, -89, -53, -25, 25, 53, 89, 117, 139, 167, 203, 231\}} = 0$$
(22-94)

where

Ψ_m is given in Table 22-21

For a noncontiguous transmission using two 80 MHz frequency segments, each frequency segment shall follow the 80 MHz pilot tone allocation and values defined for 80 MHz transmission as specified in Equation (22-93) and Table 22-21.

The above pilot mapping shall be copied to all space-time streams before the space-time stream cyclic shifts are applied.

22.3.10.11 OFDM modulation

22.3.10.11.1 Transmission in VHT format

The time domain waveform of the Data field of a VHT PPDU from transmit chain i_{TX} , $1 \leq i_{TX} \leq N_{TX}$ shall be as defined in Equation (22-95).

$$r_{\text{VHT-Data}}^{(i_{\text{Seg}}, i_{\text{TX}})}(t) = \frac{1}{\sqrt{N_{\text{VHT-Data}}^{\text{Tone}} N_{\text{STS, total}}}} \sum_{n=0}^{N_{\text{SYM}}-1} w_{T_{\text{SYM}}}(t - nT_{\text{SYM}}) \cdot \sum_{k=-N_{\text{SR}}}^{N_{\text{SR}}} \sum_{u=0}^{N_{\text{user}}-1} \sum_{m=1}^{N_{\text{STS}, u}} \left(\left[Q_k^{(i_{\text{Seg}})} \right]_{i_{\text{TX}}, (M_u + m)} \Upsilon_{k, \text{BW}}(\tilde{D}_{k, m, n, \text{BW}}^{(i_{\text{Seg}}, u)} + P_n) \cdot \exp(j2\pi k \Delta_F (t - nT_{\text{SYM}} - T_{\text{GI, Data}} - T_{\text{CS, VHT}}(M_u + m))) \right) \quad (22-95)$$

where

P_n is defined in 18.3.5.10

P_n^k is defined in 22.3.10.10

$\Upsilon_{k, \text{BW}}$ is defined in Equation (22-14), Equation (22-15), Equation (22-16), and Equation (22-17)

$\tilde{D}_{k, m, n, \text{BW}}^{(i_{\text{Seg}}, u)}$ is the transmitted constellation for user u at subcarrier k , space-time stream m , and Data field OFDM symbol n and is defined in Equation (22-96) through Equation (22-99)

$N_{\text{VHT-Data}}^{\text{Tone}}$ has the value given in Table 22-8

$T_{\text{CS, VHT}}(n)$ is given in Table 22-11

$T_{\text{GI, Data}}$ is the guard interval duration. $T_{\text{GI, Data}} = T_{\text{GI}}$ when not using the short guard interval (Short GI field of VHT-SIG-A2 is 0) and $T_{\text{GI, Data}} = T_{\text{GIS}}$ when using the short guard interval (Short GI field of VHT-SIG-A2 is 1). T_{GI} and T_{GIS} are given in Table 22-5.

For a 20 MHz VHT transmission,

$$\tilde{D}_{k, m, n, 20}^{(i_{\text{Seg}}, u)} = \begin{cases} 0, & k = 0, \pm 7, \pm 21 \\ \tilde{d}_{M_{20}^r(k), m, n, u}^{(i_{\text{Seg}})}, & \text{otherwise} \end{cases} \quad (22-96)$$

where

$M_{20}^r(k)$ is defined in Equation (22-49)

For a 40 MHz VHT transmission,

$$\tilde{D}_{k,m,n,40}^{(i_{seg},u)} = \begin{cases} 0, & k = 0, \pm 1, \pm 11, \pm 25, \pm 53 \\ \tilde{d}_{M_{40}^r(k),m,n,u}^{(i_{seg})}, & \text{otherwise} \end{cases} \quad (22-97)$$

where

$M_{40}^r(k)$ is defined in Equation (22-51)

For an 80 MHz transmission,

$$\tilde{D}_{k,m,n,80}^{(i_{seg},u)} = \begin{cases} 0, & k = 0, \pm 1, \pm 11, \pm 39, \pm 75, \pm 103 \\ \tilde{d}_{M_{80}^r(k),m,n,u}^{(i_{seg})}, & \text{otherwise} \end{cases} \quad (22-98)$$

where

$M_{80}^r(k)$ is defined in Equation (22-53)

For a 160 MHz transmission,

$$\tilde{D}_{k,m,n,160}^{(i_{seg},u)} = \begin{cases} 0, & k = 0, \pm 1, \pm 2, \pm 3, \pm 4, \pm 5, \pm 25, \pm 53, \pm 89, \pm 117, \pm 127, \pm 128, \pm 129, \pm 139, \pm 167, \pm 203, \pm 231 \\ \tilde{d}_{M_{160}^r(k),m,n,u}^{(i_{seg})}, & \text{otherwise} \end{cases} \quad (22-99)$$

where

$M_{160}^r(k)$ is defined in Equation (22-55)

For a noncontiguous 80+80 MHz transmission, each frequency segment shall follow the 80 MHz VHT subcarrier mapping as specified in Equation (22-98) and Equation (22-53).

$Q_k^{(i_{seg})}$ is a spatial mapping/steering matrix with N_{TX} rows and $N_{STS,total}$ columns for subcarrier k in frequency segment i_{seg} . $Q_k^{(i_{seg})}$ may be frequency dependent. Refer to the examples of Q_k listed in 20.3.11.11.2 for examples of $Q_k^{(i_{seg})}$ that could be used for VHT SU PPDU. Note that implementations are not restricted to the spatial mapping matrix examples listed in 20.3.11.11.2 and the number of transmit chains N_{TX} could be greater than 4. For VHT SU PPDU to which beamforming is applied, $Q_k^{(i_{seg})}$ is a beamforming steering matrix and is derived from the TXVECTOR parameter EXPANSION_MAT. For VHT MU PPDU, $Q_k^{(i_{seg})}$ is the DL-MU-MIMO steering matrix and is derived from the TXVECTOR parameter EXPANSION_MAT. The beamforming steering matrices and DL-MU-MIMO steering matrices are implementation specific.

22.3.10.12 Non-HT duplicate transmission

When the TXVECTOR parameter FORMAT is NON_HT and the TXVECTOR parameter NON_HT_MODULATION is NON_HT_DUP_OFDM, the transmitted PPDU is a non-HT duplicate. Non-HT duplicate transmission is used to transmit to non-HT OFDM STAs, HT STAs, or VHT STAs that may be present in a part of a 40 MHz, 80 MHz, or 160 MHz channel (see Table 22-2). The VHT-SIG-A, VHT-STF, VHT-LTF, and VHT-SIG-B fields are not transmitted. The L-STF, L-LTF, and L-SIG fields shall be

transmitted in the same way as in the VHT transmission, with the exceptions for the Rate and Length fields which shall follow 18.3.4.

For a 40 MHz non-HT duplicate transmission, the Data field shall be as defined by Equation (20-61).

For 80 MHz and 160 MHz non-HT duplicate transmissions, the Data field shall be as defined by Equation (22-100).

$$r_{\text{non-HT, BW}}^{i_{TX}}(t) = \frac{1}{\sqrt{N_{\text{NON_HT_DUP_OFDM-Data}}^{\text{Tone}}}} \sum_{n=0}^{N_{SYM}-1} w_{T_{SYM}}(t - nT_{SYM}) \cdot \sum_{i_{BW}=0}^{N_{20\text{MHz}}-1} \left(\sum_{k=-26}^{26} \Upsilon_{(k - K_{\text{Shift}}(i_{BW}), BW)}(D_{k,n} + p_{n+1}P_k) \cdot \exp(j2\pi(k - K_{\text{Shift}}(i_{BW}))\Delta_F(t - nT_{SYM} - T_{GI} - T_{CS}^{i_{TX}})) \right) \quad (22-100)$$

where

$N_{20\text{MHz}}$ and $K_{\text{Shift}}(i)$ are defined in 22.3.8.2.4

P_k and p_n are defined in 18.3.5.10

$D_{k,n}$ is defined in Equation (22-26)

$\Upsilon_{k, BW}$ is defined in Equation (22-16) and Equation (22-17)

$T_{CS}^{i_{TX}}$ represents the cyclic shift for transmitter chain i_{TX} with a value given in Table 22-10

$N_{\text{NON_HT_DUP_OFDM-Data}}^{\text{Tone}}$ has the value given in Table 22-8

For a noncontiguous 80+80 MHz non-HT duplicate transmission, data transmission in each frequency segment shall be as defined for an 80 MHz non-HT duplicate transmission in Equation (22-100).

22.3.11 SU-MIMO and DL-MU-MIMO Beamforming

22.3.11.1 General

SU-MIMO and DL-MU-MIMO beamforming are techniques used by a STA with multiple antennas (the beamformer) to steer signals using knowledge of the channel to improve throughput. With SU-MIMO beamforming all space-time streams in the transmitted signal are intended for reception at a single STA. With DL-MU-MIMO beamforming, disjoint subsets of the space-time streams are intended for reception at different STAs.

For SU-MIMO beamforming, the steering matrix Q_k can be determined from the beamforming feedback matrix V_k that is sent back to the beamformer by the beamformee using the compressed beamforming feedback matrix format as defined in 20.3.12.3.6. The feedback report format is described in 8.4.1.48.

For DL-MU-MIMO beamforming, the receive signal vector in subcarrier k at beamformee u , $y_{k,u} = [y_{k,0}, y_{k,1}, \dots, y_{k, N_{RX_u}-1}]^T$, is shown in Equation (22-101), where $\mathbf{x}_k = [\mathbf{x}_{k,0}^T, \mathbf{x}_{k,1}^T, \dots, \mathbf{x}_{k, N_{user}-1}^T]^T$ denotes the transmit signal vector in subcarrier k for all N_{user} beamformees, with $\mathbf{x}_{k,u} = [x_{k,0}, x_{k,1}, \dots, x_{k, N_{STS,u}-1}]^T$ being the transmit signal for beamformee u .

$$\mathbf{y}_{k,u} = \mathbf{H}_{k,u} \times [\mathcal{Q}_{k,0}, \mathcal{Q}_{k,1}, \dots, \mathcal{Q}_{k,N_{user}-1}] \times \mathbf{x}_k + \mathbf{n} \quad (22-101)$$

where

$\mathbf{H}_{k,u}$ is the channel matrix from the beamformer to beamformee u in subcarrier k with dimensions $N_{RX_u} \times N_{TX}$

N_{RX_u} is the number of receive antennas at beamformee u

$\mathcal{Q}_{k,u}$ is a steering matrix for beamformee u in subcarrier k with dimensions $N_{TX} \times N_{STS_u}$

N_{user} is the number of VHT MU PPDU recipients (see Table 22-6)

\mathbf{n} is a vector of additive noise and may include interference

The DL-MU-MIMO steering matrix $\mathcal{Q}_k = [\mathcal{Q}_{k,0}, \mathcal{Q}_{k,1}, \dots, \mathcal{Q}_{k,N_{user}-1}]$ can be determined by the beamformer using the beamforming feedback matrices for subcarrier k from beamformee u , $V_{k,u}$, and SNR information for subcarrier k from beamformee u , $SNR_{k,u}$, where $u = 0, 1, \dots, N_{user}-1$. The steering matrix that is computed (or updated) using new beamforming feedback matrices and new SNR information from some or all of participating beamformees might replace the existing steering matrix \mathcal{Q}_k for the next DL-MU-MIMO data transmission. The beamformee group for the MU transmission is signaled using the Group ID field in VHT-SIG-A (see 22.3.8.3.3 and 22.3.11.4).

22.3.11.2 Beamforming Feedback Matrix V

Upon receipt of a VHT NDP sounding PPDU, the beamformee shall remove the space-time stream CSD in Table 22-11 from the measured channel before computing a set of matrices for feedback to the beamformer. The beamforming feedback matrix, $V_{k,u}$, found by the beamformee u for subcarrier k shall be compressed in the form of angles using the method described in 20.3.12.3.6. The angles, $\phi(k,v)$ and $\psi(k,u)$, are quantized according to Table 8-53e. The number of bits for quantization is chosen by the beamformee, based on the indication from the beamformer as to whether the feedback is requested for SU-MIMO beamforming or DL-MU-MIMO beamforming. The compressed beamforming feedback using 20.3.12.3.6 is the only Clause 22 beamforming feedback format defined.

The beamformee shall generate the beamforming feedback matrices with the number of rows (N_r) equal to the N_{STS} of the NDP.

After receiving the angle information, $\phi(k,u)$ and $\psi(k,u)$, the beamformer reconstructs $V_{k,u}$ using Equation (20-79). For SU-MIMO beamforming, the beamformer can use this $V_{k,0}$ matrix to determine the steering matrix \mathcal{Q}_k . For DL-MU-MIMO beamforming, the beamformer may calculate a steering matrix $\mathcal{Q}_k = [\mathcal{Q}_{k,0}, \mathcal{Q}_{k,1}, \dots, \mathcal{Q}_{k,N_{user}-1}]$ using $V_{k,u}$ and $SNR_{k,u}$ ($0 \leq u \leq N_{user}-1$) in order to suppress crosstalk between participating beamformees. The method used by the beamformer to calculate the steering matrix \mathcal{Q}_k is implementation specific.

The beamformee decides the tone grouping value to be used in the beamforming feedback matrix V. A STA with dot11VHTSUBeamformerOptionImplemented equal to true shall support all tone grouping values and Codebook Information values.

NOTE—An MU beamformer is required to set dot11VHTSUBeamformerOptionImplemented to true (see 9.31.5).

22.3.11.3 Maximum Number of Total Spatial Streams in VHT MU PPDUs

An MU-capable STA shall support reception of VHT MU PPDUs with the total number of space-time streams across the NUM_USERS users being less than or equal to its Beamformee STS Capability in the VHT Capabilities Info field.

22.3.11.4 Group ID

A value in the Group ID field in VHT-SIG-A (see 22.3.8.3.3) in the range 1 to 62 indicates a VHT MU PPDU. Prior to transmitting a VHT MU PPDU, group assignments have been established by the AP for DL-MU-MIMO capable STAs using the Group ID Management frame as defined in 8.5.23.3.

After the STA's MLME is configured using the PHYCONFIG_VECTOR parameter GROUP_ID_MANAGEMENT, the following lookup tables are populated:

- group ID to Membership Status, denoted by MembershipStatusInGroupID[g] for $1 \leq g \leq 62$
- group ID to User Position, denoted by UserPositionInGroupID[g] for $1 \leq g \leq 62$

When a STA receives a VHT MU PPDU where the Group ID field in VHT-SIG-A has the value k and where MembershipStatusInGroupID[k] is equal to 1, then the number of space-time streams for that STA is indicated in the MU[UserPositionInGroupID[k]] NSTS field in VHT-SIG-A. The space-time streams of different users are ordered in accordance to user position values, i.e., the space-time streams for the user in user position 0 come first, followed by the space-time streams for the user in position 1, followed by the space-time streams for the user in position 2, and followed by the space-time streams for the user in position 3.

A STA is also able to identify the space-time streams intended for other STAs that act as interference. VHT-LTF symbols in the VHT MU PPDU are used to measure the channel for the space-time streams intended for the STA and can also be used to measure the channel for the interfering space-time streams. To successfully demodulate the space-time streams intended for the STA, the STA may use the channel state information for all space-time streams to reduce the effect of interfering space-time streams.

If a STA finds that it is not a member of the group, or the STA is a member of the group but the corresponding MU NSTS field in VHT-SIG-A indicates that there are zero space-time streams for the STA in the PPDU, then the STA may elect to not process the remainder of the PPDU.

22.3.12 VHT preamble format for sounding PPDUs

NDP is the only VHT sounding format.

The format of a VHT NDP PPDU is shown in Figure 22-28.

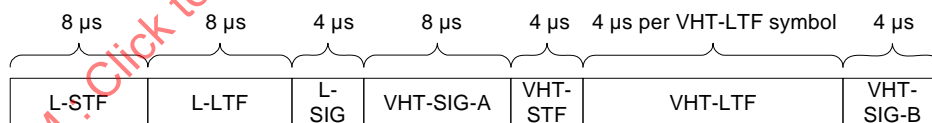

Figure 22-28—VHT NDP format

NOTE—The number of VHT-LTF symbols in the NDP is determined by the SU NSTS field in VHT-SIG-A.

The VHT NDP PPDU has the following properties:

- uses the VHT PPDU format but without the Data field
- is a VHT SU PPDU as indicated by the VHT-SIG-A field
- has the data bits of the VHT-SIG-B field set to a fixed bit pattern (see 22.3.8.3.6)

22.3.13 Regulatory requirements

Wireless LANs (WLANs) implemented in accordance with this standard are subject to equipment certification and operating requirements established by regional and national regulatory administrations. The PHY specification establishes minimum technical requirements for interoperability, based upon established regulations at the time this standard was issued. These regulations are subject to revision or may be superseded. Requirements that are subject to local geographic regulations are annotated within the PHY specification. Regulatory requirements that do not affect interoperability are not addressed in this standard. Implementers are referred to the regulatory sources in Annex D for further information. Operation in countries within defined regulatory domains might be subject to additional or alternative national regulations.

22.3.14 Channelization

A VHT channel is specified by the four PLME MIB fields specified in Table 22-22.

Table 22-22—Fields to specify VHT channels

Field	Meaning
dot11CurrentChannelWidth	Channel width. Possible values represent 20 MHz, 40 MHz, 80 MHz, 160 MHz, and 80+80 MHz channels.
dot11CurrentChannelCenterFrequencyIndex0	For a 20 MHz, 40 MHz, 80 MHz, or 160 MHz channel, denotes the channel center frequency. For an 80+80 MHz channel, denotes the center frequency of the frequency segment 0, which is the frequency segment containing the primary channel. Valid range is 1 to 200. See Equation (22-102).
dot11CurrentChannelCenterFrequencyIndex1	For an 80+80 MHz channel, denotes the center frequency of the frequency segment 1, which is the frequency segment that does not contain the primary channel. Valid range is 1 to 200. See Equation (22-102). For a 20 MHz, 40 MHz, 80 MHz, or 160 MHz channel, set to 0.
dot11CurrentPrimaryChannel	Denotes the location of the primary 20 MHz channel. Valid range is 1 to 200. See Equation (22-103).

Given dot11CurrentChannelCenterFrequencyIndex0 and dot11CurrentChannelCenterFrequencyIndex1, the respective center frequency is given by Equation (22-102).

$$\begin{aligned} & \text{Channel center frequency [MHz]} \\ & = \text{Channel starting frequency} + 5 \times \text{dot11CurrentChannelCenterFrequencyIndex} \end{aligned} \quad (22-102)$$

where

Channel starting frequency is given by the operating class (Annex E)

dot11CurrentChannelCenterFrequencyIndex is either dot11CurrentChannelCenterFrequencyIndex0 or dot11CurrentChannelCenterFrequencyIndex1

The center frequency of the primary 20 MHz channel is given by Equation (22-103).

$$\begin{aligned} & \text{Primary 20 MHz channel center frequency [MHz]} && (22-103) \\ & = \text{Channel starting frequency} + 5 \times \text{dot11CurrentPrimaryChannel} \end{aligned}$$

The channel starting frequency is defined as $\text{dot11ChannelStartingFactor} \times 500$ kHz. If a channel center frequency is 5.000 GHz, it shall be indicated by $\text{dot11ChannelStartingFactor} = 8000$ and $\text{dot11CurrentPrimaryChannel} = 200$.

For an 80+80 MHz channel, any two channels that would each be allowed as 80 MHz channels and whose center frequencies are separated by greater than 80 MHz (difference between $\text{dot11CurrentChannelCenterFrequencyIndex0}$ and $\text{dot11CurrentChannelCenterFrequencyIndex1}$ corresponds to a frequency difference greater than 80 MHz) may be used.

For example, a channel specified by
channel starting frequency = 5000 MHz
 $\text{dot11CurrentChannelWidth} = 80$ MHz
 $\text{dot11CurrentChannelCenterFrequencyIndex0} = 42$
 $\text{dot11CurrentPrimaryChannel} = 36$

is an 80 MHz channel with a center frequency of 5210 MHz and the primary 20 MHz channel centered at 5180 MHz.

A channel specified by
channel starting frequency = 5000 MHz
 $\text{dot11CurrentChannelWidth} = 160$ MHz
 $\text{dot11CurrentChannelCenterFrequencyIndex0} = 50$
 $\text{dot11CurrentPrimaryChannel} = 56$

is a 160 MHz channel with a center frequency of 5250 MHz and the primary 20 MHz channel centered at 5280 MHz.

A channel specified by
channel starting frequency = 5000 MHz
 $\text{dot11CurrentChannelWidth} = 80+80$ MHz
 $\text{dot11CurrentChannelCenterFrequencyIndex0} = 155$
 $\text{dot11CurrentChannelCenterFrequencyIndex1} = 106$
 $\text{dot11CurrentPrimaryChannel} = 161$

is an 80+80 MHz channel in which frequency segment 0 has 80 MHz bandwidth and center frequency of 5775 MHz. Frequency segment 1 also has 80 MHz bandwidth and center frequency of 5530 MHz. The primary 20 MHz channel is centered at 5805 MHz.

22.3.15 Transmit RF delay

The transmitter RF delay is defined in 18.3.8.6.

22.3.16 Slot time

The slot time for the VHT PHY shall be 9 μ s for 20 MHz, 40 MHz, 80 MHz, 160 MHz, and 80+80 MHz channel spacing.

22.3.17 Transmit and receive port impedance

Transmit and receive antenna port impedance for each transmit and receive antenna is defined in 18.3.8.8.

22.3.18 VHT transmit specification

22.3.18.1 Transmit spectrum mask

NOTE 1—In the presence of additional regulatory restrictions, the device has to meet both the regulatory requirements and the mask defined in this subclause.

NOTE 2—Transmit spectral mask figures in this subclause are not drawn to scale.

NOTE 3—For rules regarding TX center frequency leakage levels, see 22.3.18.4.2. The spectral mask requirements in this subclause do not apply to the RF LO.

For a 20 MHz mask PPDU of non-HT, HT or VHT format, the interim transmit spectral mask shall have a 0 dBr (dB relative to the maximum spectral density of the signal) bandwidth of 18 MHz, -20 dBr at 11 MHz frequency offset, -28 dBr at 20 MHz frequency offset, and -40 dBr at 30 MHz frequency offset and above. The interim transmit spectral mask for frequency offsets in between 9 and 11 MHz, 11 and 20 MHz, and 20 and 30 MHz shall be linearly interpolated in dB domain from the requirements for 9 MHz, 11 MHz, 20 MHz, and 30 MHz frequency offsets. The transmit spectrum shall not exceed the maximum of the interim transmit spectral mask and -53 dBm/MHz at any frequency offset. Figure 22-29 shows an example of the resulting overall spectral mask when the -40 dBr spectrum level is above -53 dBm/MHz.

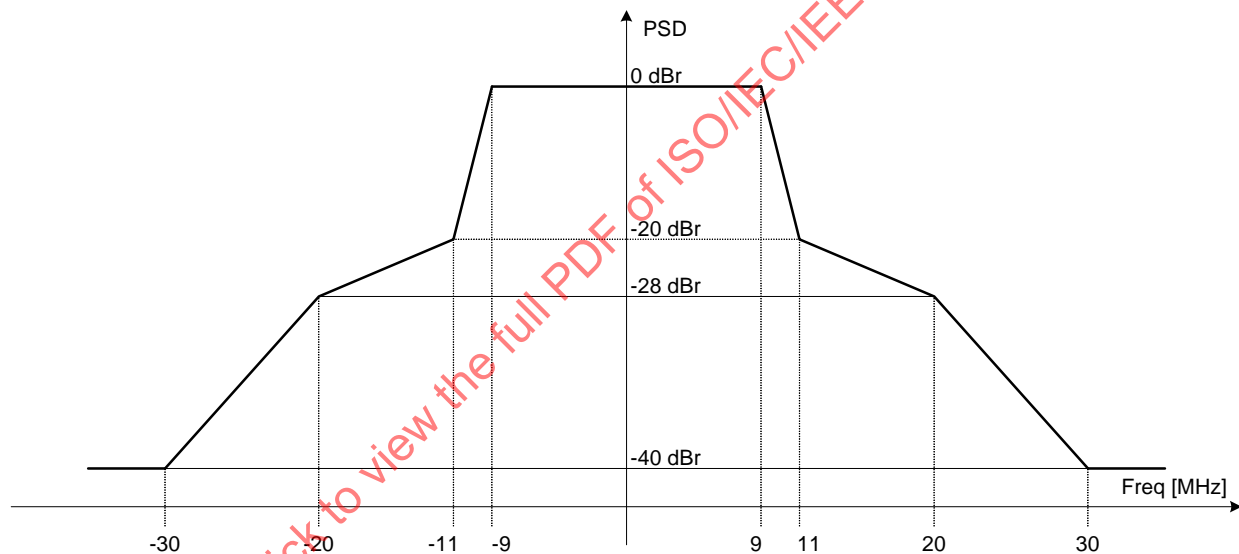

Figure 22-29—Example transmit spectral mask for a 20 MHz mask PPDU

For a 40 MHz mask PPDU of non-HT, non-HT duplicate, HT or VHT format, the interim transmit spectral mask shall have a 0 dBr (dB relative to the maximum spectral density of the signal) bandwidth of 38 MHz, -20 dBr at 21 MHz frequency offset, -28 dBr at 40 MHz frequency offset, and -40 dBr at 60 MHz frequency offset and above. The interim transmit spectral mask for frequency offsets in between 19 and 21 MHz, 21 and 40 MHz, and 40 and 60 MHz shall be linearly interpolated in dB domain from the requirements for 19 MHz, 21 MHz, 40 MHz, and 60 MHz frequency offsets. The transmit spectrum shall not exceed the maximum of the interim transmit spectral mask and -56 dBm/MHz at any frequency offset greater than 19 MHz. Figure 22-30 shows an example of the resulting overall spectral mask when the -40 dBr spectrum level is above -56 dBm/MHz.

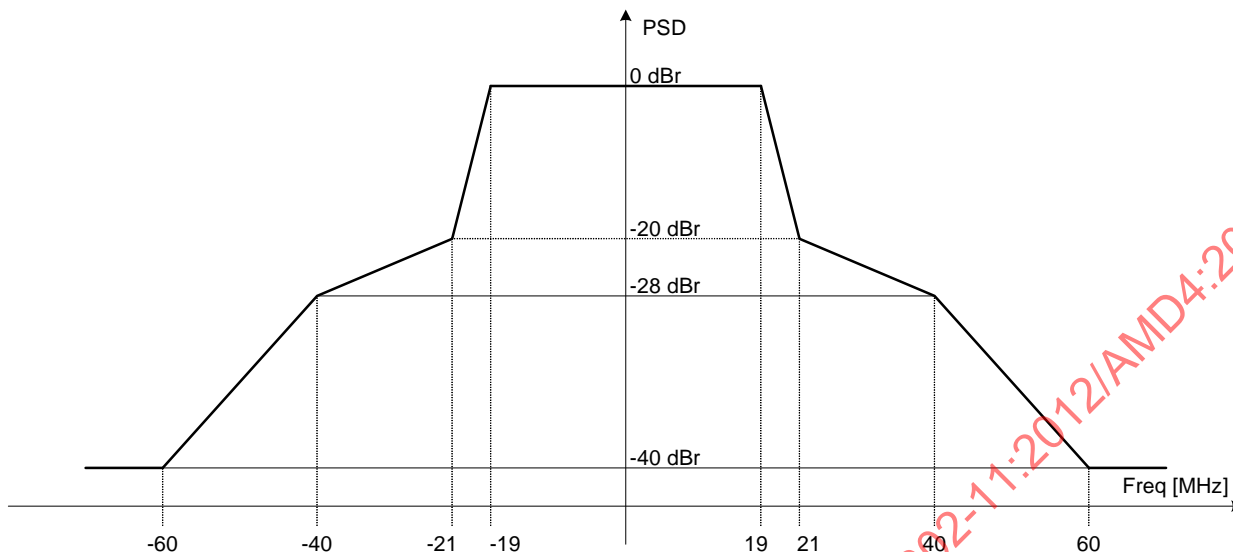

Figure 22-30—Example transmit spectral mask for a 40 MHz mask PDU

For an 80 MHz mask PDU of non-HT, non-HT duplicate, HT or VHT format, the interim transmit spectral mask shall have a 0 dBr (dB relative to the maximum spectral density of the signal) bandwidth of 78 MHz, -20 dBr at 41 MHz frequency offset, -28 dBr at 80 MHz frequency offset, and -40 dBr at 120 MHz frequency offset and above. The interim transmit spectral mask for frequency offsets in between 39 and 41 MHz, 41 and 80 MHz, and 80 and 120 MHz shall be linearly interpolated in dB domain from the requirements for 39 MHz, 41 MHz, 80 MHz, and 120 MHz frequency offsets. The transmit spectrum shall not exceed the maximum of the interim transmit spectrum mask and -59 dBm/MHz at any frequency offset. Figure 22-31 shows an example of the resulting overall spectral mask when the -40 dBr spectrum level is above -59 dBm/MHz.

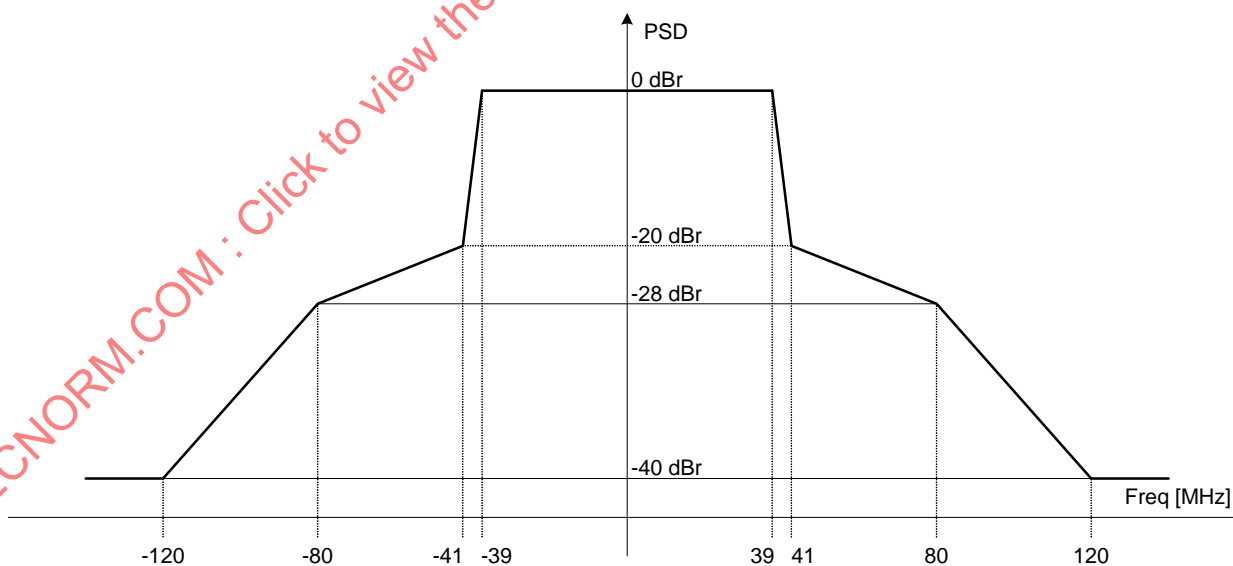

Figure 22-31—Example transmit spectral mask for an 80 MHz mask PDU

For a 160 MHz mask PPDU of non-HT, non-HT duplicate, HT or VHT format, the interim transmit spectral mask shall have a 0 dBr (dB relative to the maximum spectral density of the signal) bandwidth of 158 MHz, -20 dBr at 81 MHz frequency offset, -28 dBr at 160 MHz frequency offset, and -40 dBr at 240 MHz frequency offset and above. The interim transmit spectral mask for frequency offsets in between 79 and 81 MHz, 81 and 160 MHz, and 160 and 240 MHz shall be linearly interpolated in dB domain from the requirements for 79 MHz, 81 MHz, 160 MHz, and 240 MHz frequency offsets. The transmit spectrum shall not exceed the maximum of the interim transmit spectrum mask and -59 dBm/MHz at any frequency offset. Figure 22-32 shows an example of the resulting overall spectral mask when the -40 dBr spectrum level is above -59 dBm/MHz.

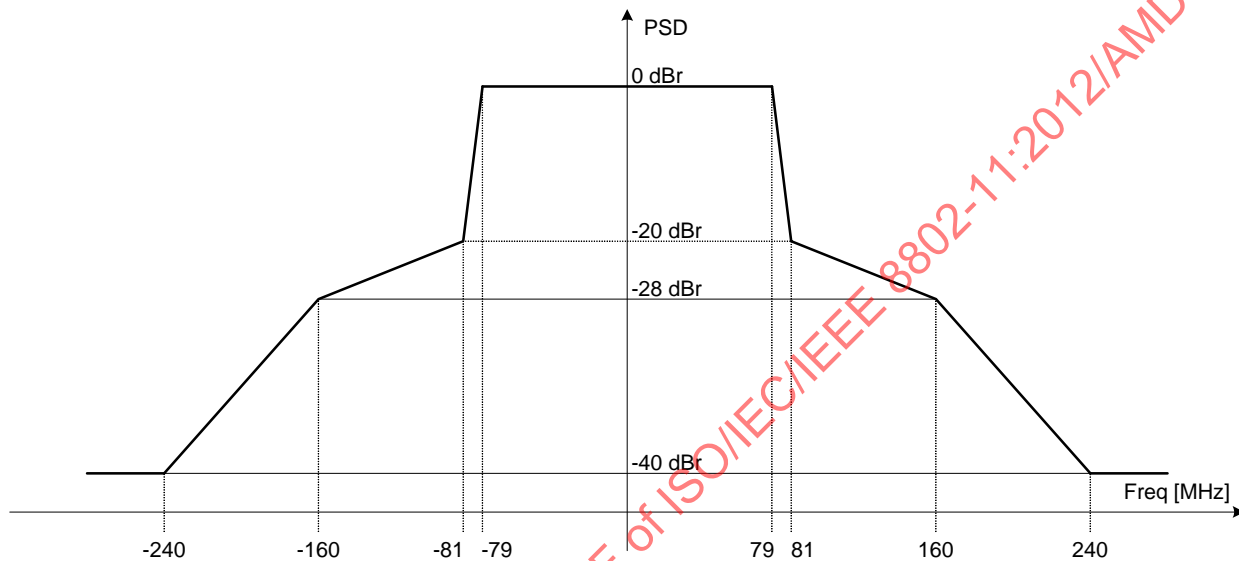

Figure 22-32—Example transmit spectral mask for a 160 MHz mask PPDU

For an 80+80 MHz mask PPDU of non-HT duplicate or VHT format, the overall transmit spectral mask is constructed in the following manner. First, the 80 MHz interim spectral mask is placed on each of the two 80 MHz segments. Then, for each frequency at which both of the 80 MHz interim spectral masks have values greater than -40 dBr and less than -20 dBr, the sum of the two interim mask values (summed in linear domain) shall be taken as the overall spectral mask value. Next, for each frequency at which neither of the two 80 MHz interim masks have values greater than or equal to -20 dBr and less than or equal to 0 dBr, the higher value of the two interim masks shall be taken as the overall interim spectral value. Finally, for any frequency region where the mask value has not been defined yet, linear interpolation (in dB domain) between the nearest two frequency points with the interim spectral mask value defined shall be used to define the interim spectral mask value. The transmit spectrum shall not exceed the maximum of the interim transmit spectrum mask and -59 dBm/MHz at any frequency offset. Figure 22-33 shows an example of a transmit spectral mask for a noncontiguous transmission using two 80 MHz channels where the center frequency of the two 80 MHz channels are separated by 160 MHz and the -40 dBr spectrum level is above -59 dBm/MHz.

Different center frequency separation between the two 80 MHz frequency segments of the spectral mask as well as different peak levels of each 80 MHz frequency segment of the spectral mask are possible, in which case a similar procedure in determining the spectral mask as in Figure 22-33 is followed.

The transmit spectral mask for noncontiguous transmissions using two nonadjacent 80 MHz channels is applicable only in regulatory domains that allow for such transmissions.

Measurements shall be made using a 100 kHz resolution bandwidth and a 30 kHz video bandwidth.

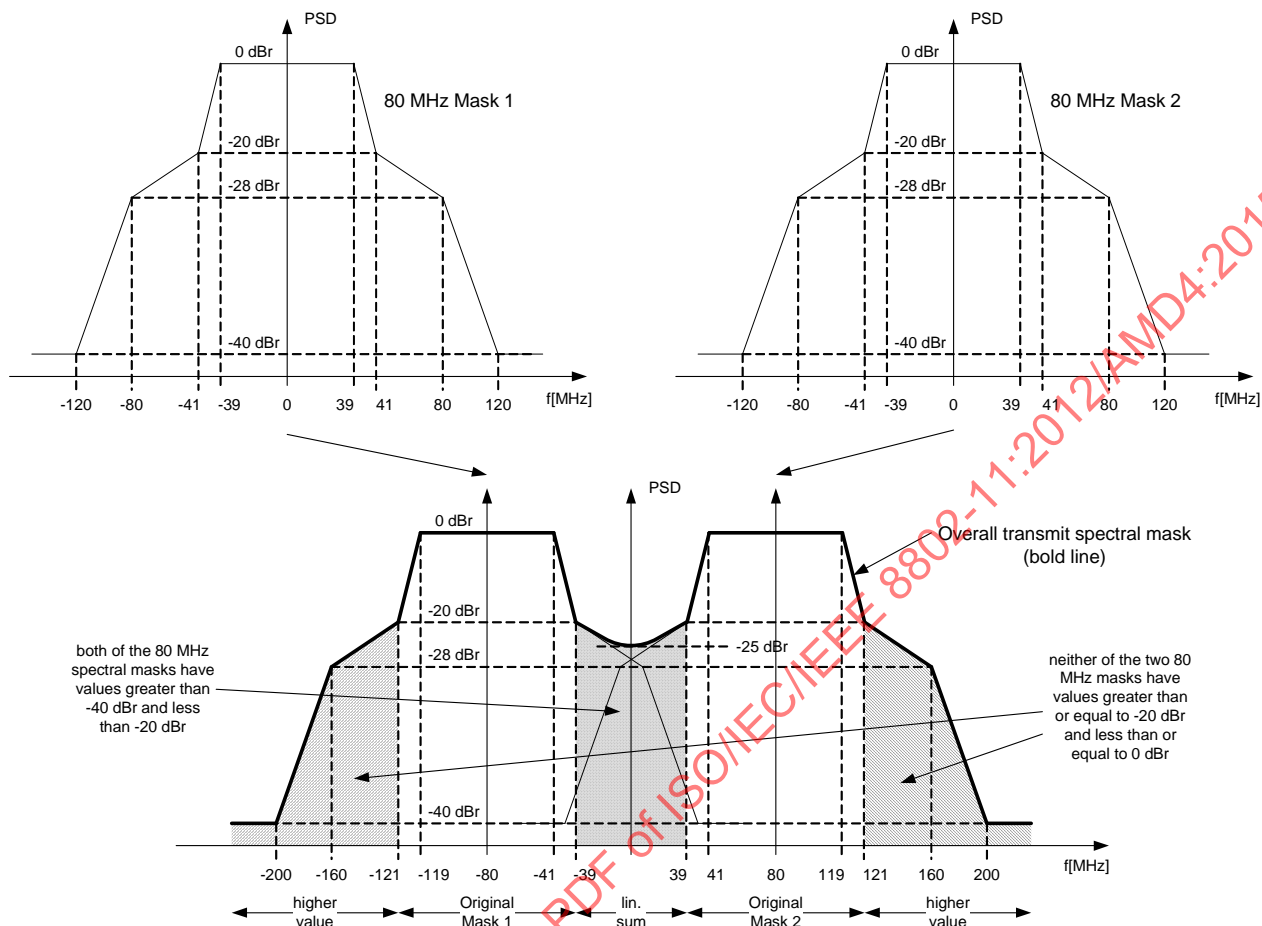

Figure 22-33—Example transmit spectral mask for an 80+80 MHz mask PPDU

22.3.18.2 Spectral flatness

Spectral flatness measurements shall be conducted using BPSK modulated PPDU. Demodulate the PPDU according to the following (or equivalent) procedure:

- Start of PPDU shall be detected.
- Transition from L-STF to L-LTF shall be detected and fine timing shall be established.
- Coarse and fine frequency offsets shall be estimated.
- Symbols in a PPDU shall be derotated according to estimated frequency offset.
- For each VHT-LTF symbol, transform the symbol into subcarrier received values, estimate the phase from the pilot subcarriers, and derotate the subcarrier values according to the estimated phase.
- For each of the data OFDM symbols: transform the symbol into subcarrier received values.

The spectral flatness test shall be performed over at least 20 PPDU. The PPDU under test shall be at least 16 data OFDM symbols long.

Evaluate spectral flatness using the subcarrier received values or the magnitude of the channel estimation.

Let $E_{i, avg}$ denote the magnitude of the channel estimation on subcarrier i or the average constellation energy of a BPSK modulated subcarrier i in a VHT data symbol.

In a contiguous non-HT duplicate or VHT transmission having a bandwidth listed in Table 22-23, $E_{i,avg}$ of each of the subcarriers with indices listed as tested subcarrier indices shall not deviate by more than the specified maximum deviation in Table 22-23 from the average of $E_{i,avg}$ over subcarrier indices listed as averaging subcarrier indices. Averaging of $E_{i,avg}$ is done in the linear domain.

Table 22-23—Maximum transmit spectral flatness deviations

Format	Bandwidth of transmission (MHz)	Averaging subcarrier indices (inclusive)	Tested subcarrier indices (inclusive)	Maximum deviation (dB)
VHT	20	-16 to -1 and +1 to +16	-16 to -1 and +1 to +16	±4
			-28 to -17 and +17 to +28	+4/-6
	40	-42 to -2 and +2 to +42	-42 to -2 and +2 to +42	±4
			-58 to -43 and +43 to +58	+4/-6
	80	-84 to -2 and +2 to +84	-84 to -2 and +2 to +84	±4
			-122 to -85 and +85 to +122	+4/-6
	160	-172 to -130, -126 to -44, +44 to +126, and +130 to +172	-172 to -130, -126 to -44, +44 to +126, and +130 to +172	±4
			-250 to -173, -43 to -6, +6 to +43, and +173 to +250	+4/-6
non-HT duplicate	40	-42 to -33, -31 to -6, +6 to +31, and +33 to +42	-42 to -33, -31 to -6, +6 to +31, and +33 to +42	±4
			-43 to -58 and +43 to +58	+4/-6
	80	-84 to -70, -58 to -33, -31 to -6, +6 to +31, +33 to +58, +70 to +84	-84 to -70, -58 to -33, -31 to -6, +6 to +31, +33 to +58, +70 to +84	±4
			-122 to -97, -95 to -85 and +85 to +95, +97 to +122	+4/-6
	160	-172 to -161, -159 to -134, -122 to -97, -95 to -70, -58 to -44, +44 to +58, +70 to +95, +97 to +122, +134 to +159, +161 to +172	-172 to -161, -159 to -134, -122 to -97, -95 to -70, -58 to -44, +44 to +58, +70 to +95, +97 to +122, +134 to +159, +161 to +172	±4
			-250 to -225, -223 to -198, -186 to -173, -43 to -33, -31 to -6, +6 to +31, +33 to +43, +173 to +186, +198 to +223, +225 to +250	+4/-6

In a noncontiguous transmission consisting of two 80 MHz frequency segments nonadjacent in frequency, each segment shall meet the spectral flatness requirement for an 80 MHz transmission.

For the spectral flatness test, the transmitting STA shall be configured to use a spatial mapping matrix Q_k (see 22.3.10.11) with flat frequency response. Each output port under test of the transmitting STA shall be connected through a cable to one input port of the testing instrumentation. The requirements apply to 20 MHz, 40 MHz, 80 MHz, and 160 MHz contiguous transmissions as well as noncontiguous 80+80 MHz transmissions.

22.3.18.3 Transmit center frequency and symbol clock frequency tolerance

The symbol clock frequency and transmit center frequency tolerance shall be ± 20 ppm maximum. The transmit center frequency and the symbol clock frequency for all transmit antennas and frequency segments shall be derived from the same reference oscillator. Transmit signals with TXVECTOR parameter CH_BANDWIDTH set to CBW160 or CBW80+80 may be generated using two separate RF LOs, one for each of the lower and upper 80 MHz frequency portions.

NOTE—The signal phase of the two 80 MHz frequency portions might not be correlated.

22.3.18.4 Modulation accuracy

22.3.18.4.1 Introduction to modulation accuracy tests

Transmit modulation accuracy specifications are described in 22.3.18.4.2 and 22.3.18.4.3. The test method is described in 22.3.18.4.4.

22.3.18.4.2 Transmit center frequency leakage

TX LO leakage shall meet the following requirements for all formats and bandwidths except noncontiguous 80+80 MHz where the RF LO falls outside both frequency segments:

- When the RF LO is in the center of the transmitted PPDU BW, the power measured at the center of transmission BW using resolution BW 312.5 kHz shall not exceed the average power per-subcarrier of the transmitted PPDU, or equivalently, $(P - 10 \log_{10}(N_{ST}))$, where P is the transmit power per antenna in dBm, and N_{ST} is defined in Table 22-5.
- When the RF LO is not at the center of the transmitted PPDU BW, the power measured at the location of the RF LO using resolution BW 312.5 kHz shall not exceed the maximum of -32 dB relative to the total transmit power and -20 dBm, or equivalently $\max(P - 32, -20)$, where P is the transmit power per antenna in dBm, and N_{ST} is defined in Table 22-5.

For an 80+80 MHz transmission where the RF LO falls outside both frequency segments, the RF LO shall follow the spectral mask requirements as defined in 22.3.18.1.

The transmit center frequency leakage is specified per antenna.

22.3.18.4.3 Transmitter constellation error

The relative constellation RMS error, calculated by first averaging over subcarriers, frequency segments, OFDM PPDU, and spatial streams (see Equation (20-89)) shall not exceed a data-rate dependent value according to Table 22-24. The number of spatial streams under test shall be equal to the number of utilized transmitting STA antenna (output) ports and also equal to the number of utilized testing instrumentation input ports. In the test, $N_{SS} = N_{STS}$ (no STBC) shall be used. Each output port of the transmitting STA shall be connected through a cable to one input port of the testing instrumentation. The requirements apply to 20 MHz, 40 MHz, 80 MHz, and 160 MHz contiguous transmissions as well as 80+80 MHz noncontiguous transmissions.

For non-HT duplicate transmissions, requirements defined in 18.3.9.7.4 apply to each 20 MHz subchannel.

Table 22-24—Allowed relative constellation error versus constellation size and coding rate

Modulation	Coding rate	Relative constellation error (dB)
BPSK	1/2	–5
QPSK	1/2	–10
QPSK	3/4	–13
16-QAM	1/2	–16
16-QAM	3/4	–19
64-QAM	2/3	–22
64-QAM	3/4	–25
64-QAM	5/6	–27
256-QAM	3/4	–30
256-QAM	5/6	–32

22.3.18.4.4 Transmitter modulation accuracy (EVM) test

The transmit modulation accuracy test shall be performed by instrumentation capable of converting the transmitted signals into a stream of complex samples at sampling rate greater than or equal to the bandwidth of the signal being transmitted; except that

- For non-HT duplicate transmissions, each 20 MHz subchannel may be tested independently while all subchannels are being transmitted and
- For noncontiguous transmissions, each frequency segment may be tested independently while both segments are being transmitted.

In this case, transmit modulation accuracy of each segment shall meet the required value in Table 22-24 using only the subcarriers within the corresponding segment.

The instrument shall have sufficient accuracy in terms of I/Q arm amplitude and phase balance, DC offsets, phase noise, and analog to digital quantization noise. A possible embodiment of such a setup is converting the signals to a low IF frequency with a microwave synthesizer, sampling the signal with a digital oscilloscope and decomposing it digitally into quadrature components. The sampled signal shall be processed in a manner similar to an actual receiver, according to the following steps, or equivalent procedure:

- a) Start of PPDU shall be detected.
- b) Transition from L-STF to L-LTF shall be detected and fine timing shall be established.
- c) Coarse and fine frequency offsets shall be estimated.
- d) Symbols in a PPDU shall be derotated according to estimated frequency offset.
- e) For each VHT-LTF symbol, transform the symbol into subcarrier received values, estimate the phase from the pilot subcarriers, and derotate the subcarrier values according to the estimated phase.
- f) Estimate the complex channel response coefficient for each of the subcarriers and each of the transmit streams.
- g) For each of the data OFDM symbols: transform the symbol into subcarrier received values, estimate the phase from the pilot subcarriers, derotate the subcarrier values according to the estimated phase, group the results from all the receiver chains in each subcarrier to a vector, and multiply the vector by a zero-forcing equalization matrix generated from the estimated channel.

- h) For each data-carrying subcarrier in each spatial stream, find the closest constellation point and compute the Euclidean distance from it.
- i) Compute the average across PPDU's of the RMS of all errors per PPDU as given by Equation (20-89).

NOTE—In the case the transmit modulation accuracy test is performed simultaneously for the two frequency segments of the noncontiguous 80+80 MHz transmissions, N_{ST} in Equation (20-89) represents the total number of subcarriers of both 80 MHz frequency segments.

The test shall be performed over at least 20 PPDU's (N_f as defined in Equation (20-89)). The PPDU's under test shall be at least 16 data OFDM symbols long. Random data shall be used for the symbols.

22.3.18.5 Time of Departure accuracy

The Time of Departure accuracy test evaluates TIME_OF_DEPARTURE against aTxPHYTxStartRMS and aTxPHYTxStartRMS against TIME_OF_DEPARTURE_ACCURACY_TEST_THRESH, as defined in Annex T with the following test parameters:

- MULTICHANNEL_SAMPLING_RATE is:

$$20 \times 10^6 \left(1 + \left\lceil \frac{f_H - f_L}{20 \text{ MHz}} \right\rceil \right) \text{ sample/s, for a CH_BANDWIDTH parameter equal to CBW20}$$

$$40 \times 10^6 \left(1 + \left\lceil \frac{f_H - f_L}{40 \text{ MHz}} \right\rceil \right) \text{ sample/s, for a CH_BANDWIDTH parameter equal to CBW40}$$

$$80 \times 10^6 \left(1 + \left\lceil \frac{f_H - f_L}{80 \text{ MHz}} \right\rceil \right) \text{ sample/s, for a CH_BANDWIDTH parameter equal to CBW80}$$

$$160 \times 10^6 \left(1 + \left\lceil \frac{f_H - f_L}{160 \text{ MHz}} \right\rceil \right) \text{ sample/s, for a CH_BANDWIDTH parameter equal to CBW160 or CBW80+80}$$

where

f_H is the nominal center frequency in Hz of the highest channel in the channel set

f_L is the nominal center frequency in Hz of the lowest channel in the channel set, the channel set is the set of channels upon which frames providing measurements are transmitted, the channel set comprises channels uniformly spaced across

$$f_H - f_L \leq 50 \text{ MHz}$$

$\lceil x \rceil$ equals the smallest integer equal to or larger than x .

- FIRST_TRANSITION_FIELD is L-STF.
- SECOND_TRANSITION_FIELD is L-LTF.
- TRAINING_FIELD is L-LTF windowed in a manner which should approximate the windowing described in 18.3.2.5 (Mathematical conventions in the signal descriptions) with TTR = 100 ns.
- TIME_OF_DEPARTURE_ACCURACY_TEST_THRESH is 80 ns.

NOTE—The indicated windowing applies to the time of departure accuracy test equipment, and not the transmitter or receiver.

22.3.19 VHT receiver specification

For tests in this subclause, the input levels are measured at the antenna connectors and are referenced as the average power per receive antenna. The number of spatial streams under test shall be equal to the number of utilized transmitting STA antenna (output) ports and also equal to the number of utilized Device Under Test input ports. Each output port of the transmitting STA shall be connected through a cable to one input port of the Device Under Test.

22.3.19.1 Receiver minimum input sensitivity

The packet error ratio (PER) shall be less than 10% for a PSDU length of 4096 octets with the rate-dependent input levels listed in Table 22-25. The test in this subclause and the minimum sensitivity levels specified in Table 22-25 apply only to non-STBC modes, 800 ns GI, BCC, and VHT PPDU.

Table 22-25—Receiver minimum input level sensitivity

Modulation	Rate (R)	Minimum sensitivity (20 MHz PPDU) (dBm)	Minimum sensitivity (40 MHz PPDU) (dBm)	Minimum sensitivity (80 MHz PPDU) (dBm)	Minimum sensitivity (160 MHz or 80+80 MHz PPDU) (dBm)
BPSK	1/2	−82	−79	−76	−73
QPSK	1/2	−79	−76	−73	−70
QPSK	3/4	−77	−74	−71	−68
16-QAM	1/2	−74	−71	−68	−65
16-QAM	3/4	−70	−67	−64	−61
64-QAM	2/3	−66	−63	−60	−57
64-QAM	3/4	−65	−62	−59	−56
64-QAM	5/6	−64	−61	−58	−55
256-QAM	3/4	−59	−56	−53	−50
256-QAM	5/6	−57	−54	−51	−48

22.3.19.2 Adjacent channel rejection

Adjacent channel rejection for W MHz channels (where W is 20, 40, 80 or 160) shall be measured by setting the desired signal's strength 3 dB above the rate dependent sensitivity specified in Table 22-25 and raising the power of the interfering signal of W MHz bandwidth until 10% PER is caused for a PSDU length of 4096 octets. The power difference between the interfering and desired channel is the corresponding adjacent channel rejection. The center frequency of the adjacent channel shall be placed W MHz away from the center frequency of the desired signal.

Adjacent channel rejection for 80+80 MHz channels shall be measured by setting the desired signal's strength 3 dB above the rate dependent sensitivity specified in Table 22-25. Then, an interfering signal of 80 MHz bandwidth is introduced, where the center frequency of the interfering signal is placed 80 MHz away from the center frequency of the frequency segment lower in frequency of the desired signal. The power of the interfering signal is raised until 10% PER is caused for a PSDU length of 4096 octets. Let ΔP_1 be the power difference between the interfering and desired signal. Next, the interfering signal of 80 MHz

bandwidth is moved to a frequency where the center frequency of the interfering signal is 80 MHz away from the center frequency of the frequency segment higher in frequency of the desired signal. The power of the interfering signal is raised until 10% PER is caused for a PSDU length of 4096 octets. Let ΔP_2 be the power difference between the interfering and desired signal. The smaller value between ΔP_1 and ΔP_2 is the corresponding adjacent channel rejection.

The interfering signal in the adjacent channel shall be a conformant OFDM signal, unsynchronized with the signal in the channel under test, and shall have a minimum duty cycle of 50%. For a conforming OFDM PHY, the corresponding rejection shall be no less than specified in Table 22-26.

The test in this subclause and the adjacent sensitivity levels specified in Table 22-26 apply only to non-STBC modes, 800 ns GI, BCC, and VHT PPDU.

Table 22-26—Minimum required adjacent and nonadjacent channel rejection levels

Modulation	Rate (R)	Adjacent channel rejection (dB)		Nonadjacent channel rejection (dB)	
		20/40/80/ 160 MHz Channel	80+80 MHz Channel	20/40/80/ 160 MHz Channel	80+80 MHz Channel
BPSK	1/2	16	13	32	29
QPSK	1/2	13	10	29	26
QPSK	3/4	11	8	27	24
16-QAM	1/2	8	5	24	21
16-QAM	3/4	4	1	20	17
64-QAM	2/3	0	-3	16	13
64-QAM	3/4	-1	-4	15	12
64-QAM	5/6	-2	-5	14	11
256-QAM	3/4	-7	-10	9	6
256-QAM	5/6	-9	-12	7	4

The measurement of adjacent channel rejection for 160 MHz operation in a regulatory domain is required only if such a frequency band plan is permitted in that regulatory domain.

22.3.19.3 Nonadjacent channel rejection

Nonadjacent channel rejection for W MHz channels (where W is 20, 40, 80, or 160) shall be measured by setting the desired signal's strength 3 dB above the rate-dependent sensitivity specified in Table 22-25, and raising the power of the interfering signal of W MHz bandwidth until a 10% PER occurs for a PSDU length of 4096 octets. The power difference between the interfering and desired channel is the corresponding nonadjacent channel rejection. The nonadjacent channel rejection shall be met with any nonadjacent channels located at least $2 \times W$ MHz away from the center frequency of the desired signal.

Nonadjacent channel rejection for 80+80 MHz channels shall be measured by setting the desired signal's strength 3 dB above the rate dependent sensitivity specified in Table 22-25. Then, an interfering signal of 80 MHz bandwidth is introduced, where the center frequency of the interfering signal is placed at least 160 MHz away from the center frequency of the frequency segment lower in frequency of the desired signal. The center frequency of the interfering signal shall also be at least 160 MHz away from the center frequency

of the frequency segment higher in frequency of the desired signal. The power of the interfering signal is raised until 10% PER is caused for a PSDU length of 4096 octets. Let ΔP_1 be the power difference between the interfering and desired signal. Next, the interfering signal of 80 MHz bandwidth is moved to a frequency where the center frequency of the interfering signal is at least 160 MHz away from the center frequency of the frequency segment higher in frequency of the desired signal. The center frequency of the interfering signal shall also be at least 160 MHz away from the center frequency of the frequency segment lower in frequency of the desired signal. The power of the interfering signal is raised until 10% PER is caused for a PSDU length of 4096 octets. Let ΔP_2 be the power difference between the interfering and desired channel. The smaller value between ΔP_1 and ΔP_2 is the corresponding nonadjacent channel rejection.

The interfering signal in the nonadjacent channel shall be a conformant OFDM signal, unsynchronized with the signal in the channel under test, and shall have a minimum duty cycle of 50%. For a conforming OFDM PHY, the corresponding rejection shall be no less than specified in Table 22-26.

The test in this subclause and the nonadjacent sensitivity levels specified in Table 22-26 apply only to non-STBC modes, 800 ns GI, BCC, and VHT PPDU.

The measurement of non-adjacent channel rejection for 160 MHz operation in a regulatory domain is only required if such a frequency band plan is permitted in that regulatory domain.

22.3.19.4 Receiver maximum input level

The receiver shall provide a maximum PER of 10% at a PSDU length of 4096 octets, for a maximum input level of -30 dBm, measured at each antenna for any baseband VHT modulation.

22.3.19.5 CCA sensitivity

22.3.19.5.1 General

The thresholds in this subclause are compared with the signal level at each receiving antenna.

22.3.19.5.2 CCA sensitivity for operating classes requiring CCA-ED

For the operating classes requiring CCA-Energy Detect (CCA-ED), CCA shall also detect a medium busy condition when CCA-ED detects a channel busy condition.

For improved spectrum sharing, CCA-ED is required in some bands. The behavior class indicating CCA-ED is given in Table D-2. The operating classes requiring the corresponding CCA-ED behavior class are given in Annex E. A STA that is operating within an operating class that requires CCA-ED shall operate with CCA-ED. The CCA-ED is not required for license-exempt operation in any band.

CCA-ED shall indicate a channel busy condition when the received signal strength exceeds the CCA-ED threshold as given by `dot11OFDMEDThreshold` for the primary 20 MHz channel and the secondary 20 MHz channel, `dot11OFDMEDThreshold + 3 dB` for the secondary 40 MHz channel, and `dot11OFDMEDThreshold+6 dB` for the secondary 80 MHz channel. The CCA-ED thresholds for the operating classes requiring CCA-ED are subject to the criteria in D.2.5.

NOTE—The requirement to issue a CCA signal busy as stated in 22.3.19.5.3 and 22.3.19.5.4 is a mandatory energy detect requirement on all Clause 22 receivers. Support for CCA-ED is an additional requirement that relates specifically to the sensitivities described in D.2.5.

22.3.19.5.3 CCA sensitivity for signals occupying the primary 20 MHz channel

The PHY shall issue a `PHY-CCA.indication(BUSY, {primary})` if one of the conditions listed in Table 22-27 is met in an otherwise idle 20 MHz, 40 MHz, 80 MHz, 160 MHz, or 80+80 MHz operating channel

width. With >90% probability, the PHY shall detect the start of a PPDU that occupies at least the primary 20 MHz channel under the conditions listed in Table 22-27 within a period of aCCATime (see 22.4.4) and hold the CCA signal busy (PHY_CCA.indicate(BUSY, channel-list)) for the duration of the PPDU.

Table 22-27—Conditions for CCA BUSY on the primary 20 MHz

Operating Channel Width	Conditions
20 MHz, 40 MHz, 80 MHz, 160 MHz, or 80+80 MHz	The start of a 20 MHz NON_HT PPDU in the primary 20 MHz channel as defined in 18.3.10.6. The start of an HT PPDU under the conditions defined in 20.3.21.5. The start of a 20 MHz VHT PPDU in the primary 20 MHz channel at or above -82 dBm.
40 MHz, 80 MHz, 160 MHz, or 80+80 MHz	The start of a 40 MHz non-HT duplicate or VHT PPDU in the primary 40 MHz channel at or above -79 dBm. The start of an HT PPDU under the conditions defined in 20.3.21.5.
80 MHz, 160 MHz, or 80+80 MHz	The start of an 80 MHz non-HT duplicate or VHT PPDU in the primary 80 MHz channel at or above -76 dBm.
160 MHz or 80+80 MHz	The start of a 160 MHz or 80+80 MHz non-HT duplicate or VHT PPDU at or above -73 dBm.

The receiver shall issue a PHY-CCA.indication(BUSY, {primary}) for any signal that exceeds a threshold equal to 20 dB above the minimum modulation and coding rate sensitivity ($-82 + 20 = -62$ dBm) in the primary 20 MHz channel within a period of aCCATime after the signal arrives at the receiver's antenna(s); then the receiver shall not issue a PHY-CCA.indication(BUSY,{secondary}), PHY-CCA.indication(BUSY,{secondary40}), PHY-CCA.indication(BUSY,{secondary80}), or PHY-CCA.indication(IDLE) while the threshold continues to be exceeded.

22.3.19.5.4 CCA sensitivity for signals not occupying the primary 20 MHz channel

The PHY shall issue a PHY-CCA.indication(BUSY, {secondary}) if the conditions for issuing PHY-CCA.indication(BUSY, {primary}) are not present and one of the following conditions are present in an otherwise idle 40 MHz, 80 MHz, 160 MHz, or 80+80 MHz operating channel width:

- Any signal within the secondary 20 MHz channel at or above a threshold of -62 dBm within a period of aCCATime after the signal arrives at the receiver's antenna(s); then the PHY shall not issue a PHY-CCA.indication(BUSY,{secondary40}), PHY-CCA.indication(BUSY,{secondary80}), or PHY-CCA.indication(IDLE) while the threshold continues to be exceeded.
- A 20 MHz NON_HT, HT_MF, HT_GF or VHT PPDU detected in the secondary 20 MHz channel at or above -72 dBm with >90% probability within a period aCCAMidTime (see 22.4.4).

The PHY shall issue a PHY-CCA.indication(BUSY, {secondary40}) if the conditions for issuing PHY-CCA.indication(BUSY, {primary}) and PHY-CCA.indication(BUSY, {secondary}) are not present and one of the following conditions are present in an otherwise idle 80 MHz, 160 MHz, or 80+80 MHz operating channel width:

- Any signal within the secondary 40 MHz channel at or above a threshold of -59 dBm within a period of aCCATime after the signal arrives at the receiver's antenna(s); then the PHY shall not issue a PHY-CCA.indication(BUSY, {secondary80}) or PHY-CCA.indication(IDLE) while the threshold continues to be exceeded.
- A 40 MHz non-HT duplicate, HT_MF, HT_GF or VHT PPDU detected in the secondary 40 MHz channel at or above -72 dBm with >90% probability within a period aCCAMidTime (see 22.4.4).

- A 20 MHz non-HT, HT_MF, HT_GF or VHT PPDU detected in any 20 MHz sub-channel of the secondary 40 MHz channel at or above -72 dBm with $>90\%$ probability within a period aCCAMidTime.

The PHY shall issue a PHY-CCA.indication(BUSY, {secondary80}) if the conditions for PHY-CCA.indication(BUSY, {primary}), PHY-CCA.indication(BUSY, {secondary}), and PHY-CCA.indication(BUSY, {secondary40}) are not present and one of the following conditions are present in an otherwise idle 160 MHz or 80+80 MHz operating channel width:

- Any signal within the secondary 80 MHz channel at or above -56 dBm.
- An 80 MHz non-HT duplicate or VHT PPDU detected in the secondary 80 MHz channel at or above -69 dBm with $>90\%$ probability within a period aCCAMidTime (see 22.4.4).
- A 40 MHz non-HT duplicate, HT_MF, HT_GF or VHT PPDU detected in any 40 MHz sub-channel of the secondary 80 MHz channel at or above -72 dBm with $>90\%$ probability within a period aCCAMidTime.
- A 20 MHz NON_HT, HT_MF, HT_GF or VHT PPDU detected in any 20 MHz sub-channel of the secondary 80 MHz channel at or above -72 dBm with $>90\%$ probability within a period aCCAMidTime.

22.3.19.6 RSSI

The RSSI parameter returned in the RXVECTOR shall be calculated during the reception of the VHT-LTFs and shall be a monotonically increasing function of the received power.

22.3.20 PHY transmit procedure

There are two paths for the transmit PHY procedure:

- The first path, for which typical transmit procedures are shown in Figure 22-34, is selected if the FORMAT parameter of the PHY-TXSTART.request(TXVECTOR) primitive is VHT. These transmit procedures do not describe the operation of optional features, such as LDPC, STBC or MU.
- The second path is to follow the transmit procedure in Clause 18 if the FORMAT parameter of the PHY-TXSTART.request(TXVECTOR) primitive is NON_HT and the NON_HT_MODULATION parameter is set to NON_HT_DUP_OFDM except that the signal referred to in Clause 18 is instead generated simultaneously on each of the 20 MHz channels that are indicated by the CH_BANDWIDTH parameter as defined in 22.3.8 and 22.3.10.12.

NOTE 1—For a VHT MU PPDU the A-MPDU is per user in the MAC sublayer and the VHT Training Symbols, VHT-SIG-B, and Data are per user in the PHY layer in Figure 22-34, with the number VHT Training Symbols depending on the total number of space-time streams across all users.

NOTE 2—The transmit procedure for NON_HT format where NON_HT_MODULATION is OFDM is specified in 22.2.4.2. The transmit procedure for HT_MF and HT_GF formats is specified in 22.2.4.3.

In both paths, in order to transmit data, the MAC generates a PHY-TXSTART.request primitive, which causes the PHY entity to enter the transmit state. Further, the PHY is set to operate at the appropriate frequency through station management via the PLME, as specified in 22.4. Other transmit parameters, such as VHT-MCS Coding types and transmit power, are set via the PHY-SAP using the PHY-TXSTART.request(TXVECTOR) primitive, as described in 22.2.2. The remainder of the clause applies to the first path.

The PHY indicates the state of the primary channel and other channels (if any) via the PHY-CCA.indication primitive (see 22.3.19.5 and 7.3.5.11). Transmission of the PPDU shall be initiated by the PHY after receiving the PHY-TXSTART.request(TXVECTOR) primitive. The TXVECTOR elements for the PHY-TXSTART.request primitive are specified in Table 22-1.