

AMERICAN NATIONAL STANDARD

Symbols for Mechanical and Acoustical Elements as Used in Schematic Diagrams

ANSI Y32.18 - 1972

~~REAFFIRMED 1978~~
REAFFIRMED 1998

FOR CURRENT COMMITTEE PERSONNEL
PLEASE SEE ASME MANUAL AS-11

SECRETARIAT

INSTITUTE OF ELECTRICAL AND ELECTRONICS ENGINEERS
THE AMERICAN SOCIETY OF MECHANICAL ENGINEERS

PUBLISHED BY

THE AMERICAN SOCIETY OF MECHANICAL ENGINEERS

United Engineering Center

345 East 47th Street

New York, N. Y. 10017

ASMENORMDOC.COM : Click to view the full PDF of ASME Y32.18 1972

No part of this document may be reproduced in any form,
in an electronic retrieval system or otherwise,
without the prior written permission of the publisher.

Copyright ©, 1972, by
THE AMERICAN SOCIETY OF MECHANICAL ENGINEERS
Printed in U.S.A.

FOREWORD

Ever increasing use has been made during recent decades of schematic diagrams in representing mechanical and acoustical systems. This development is a natural outgrowth of the same technique as was developed earlier for electric networks. Such diagrams are important because of their usefulness in two connections.

First, a mechanical or an acoustical system can be analyzed much more rapidly with a schematic diagram than without. Indeed, systematic methods have been developed in recent years which can generate correct descriptive equations for the system given its schematic diagram and specifications of the properties of each element in the system. Furthermore, the use of such methods tends to minimize blunders in analyses, such as wrong signs for terms, which even the most experienced analyst is apt to make from time to time.

Second, as an analyst gains experience with schematic diagrams he develops an insight into the characteristic performance of collections of interconnected elements. Thus he develops an ability to anticipate the performance of a system, at least in a qualitative way, based solely on a study of its schematic diagram. This is an attribute of schematic diagrams that is most useful, as was discovered earlier by electrical and electrical and electronics engineers.

It is to be noted that each of the foregoing points concerns a determination of the performance of a system; i.e., an analysis of the system. It is not surprising, therefore, that schematic symbols are constructed primarily to make analyses easier and more straightforward. In recent years, however, there has developed a considerable interest in schematic diagrams in connection with the synthesis problem. From this point of view one starts with a specification of the overall performance desired in a system. If some specifications are then assigned to the schematic diagram, such as the number of junctions and branches in the diagram, it is conceivable that the constitutive equations for the elements can be determined. Although techniques of this sort have not been worked out in detail as yet, they are receiving a lot of attention at the time of this writing and hold great promises for the future.

Because this standard concerns a relatively new field, the Writing Group was forced to make some decisions. The most important one concerned the question whether it is desirable to try to evolve some standard symbols now rather than to wait a number of years in the hope that some fairly uniform practices may evolve. It is recognized that standards are much easier to establish if a unanimity of opinion exists. The Writing Group believed, however, that a significant contribution could be made to an evolving practice if some sort of a standard practice could be adopted now. No doubt, any user of this standard will find some things that he likes and some that he would like to see changed. Suggestions for improvement based on experience gained in the use of this standard will always be welcome and should be mailed to the Secretary, American National Standards Committee Y32, in care of the ASME.

This standard was prepared by a committee working under the auspices of the American National Standards Committee on Acoustics, S1, and the American National Standards Committee on Mechanical Shock and Vibration, S2. It was approved by the above American National Standards Committees and by American National Standards Committee Y32 on Graphic Symbols and Designations on November 23, 1971 when it was sent to American National Standard Institute for approval as an American National Standard. The ANSI approval was received on April 20, 1972 and it was designated ANSI Y32.18-1972.

AMERICAN NATIONAL STANDARDS COMMITTEE Y32

GRAPHIC SYMBOLS AND DESIGNATIONS

OFFICERS

C. A. Fricke, *Chairman*
J. L. Fisher, *Vice Chairman - Mechanical*
W. L. Hewetson, *Vice Chairman - Chemical and Process*
L. A. Meadows, *Vice Chairman - Government Liaison*
C. R. Muller, *Vice Chairman - Electrical*
S. I. Sherr, *Secretary*

COMMITTEE MEMBERS

ACOUSTICAL SOCIETY OF AMERICA

Laurence Batchelder, 983 Memorial Drive, Cambridge, Massachusetts 02138
H. F. Olson, R.C.A. Laboratories, Princeton, New Jersey

AMERICAN CHEMICAL SOCIETY

R. F. Schuerer, Linden, New Jersey

AMERICAN GEAR MANUFACTURERS ASSOCIATION

Gene L. Scott, American Gear Manufacturers Association, Washington, D.C.

AMERICAN INSTITUTE OF CHEMICAL ENGINEERS

J. R. Couper, University of Arkansas, Fayetteville, Arkansas
W. L. Hewetson, American Institute of Industrial Engineers, New York, New York
I. R. Goldstein, Newark College of Engineering, Newark, New Jersey

AMERICAN INSTITUTE OF MINING, METALLURGICAL AND PETROLEUM ENGINEERS

J. W. Warren, The Anaconda Company, Butte, Montana

AMERICAN SOCIETY OF AGRICULTURAL ENGINEERS

J. A. Basselman, American Society of Agricultural Engineers, St. Joseph, Michigan.
P. L. Bellinger, Alternate, American Society of Agricultural Engineers, St. Joseph, Michigan

AMERICAN SOCIETY OF CIVIL ENGINEERS

K. R. Jacobs, Georgia Institute of Technology, Atlanta, Georgia

AMERICAN SOCIETY FOR ENGINEERING EDUCATION

I. L. Hill, Illinois Institute of Technology, Chicago, Illinois
J. G. McGuire, Texas A & M College, College Station, Texas
R. T. Northrup, Wayne State University, Detroit, Michigan

AMERICAN SOCIETY OF HEATING, REFRIGERATING AND AIR-CONDITIONING ENGINEERS

*C. F. Kayan, Columbia University, New York, New York
G. W. MacPhee, Alternate, ASHRAE, New York, N.Y.
N. LaCourte, Alternate, ASHRAE, New York, N.Y.

AMERICAN SOCIETY OF MECHANICAL ENGINEERS, THE

R. W. Cockrell, Fluor Corp. Ltd., Los Angeles, California
A. R. Machell, Jr., Xerox Corporation, Rochester, New York
O. J. Maha, Parker-Hannifin Corporation, Cleveland, Ohio
H. E. Walchi, Westinghouse Electric Corporation, Pittsburgh, Pennsylvania

AMERICAN SOCIETY OF SANITARY ENGINEERING

J. C. Church, Mamaroneck, New York

AMERICAN WATER WORKS ASSOCIATION

R. R. Kountz, American Water Works Association, University Park, Pennsylvania

AMERICAN WELDING SOCIETY

W. E. McKenzie, U.S. Naval Weapons Laboratory, Dahlgren, Virginia

ASSOCIATION OF AMERICAN RAILROADS

M. F. McCorcle, St. Louis-San Francisco Railway, Springfield, Missouri
C. W. Martin, Alternate, Baltimore & Ohio Railroad, Baltimore, Maryland
J. L. McNabb, Association of American Railroads, Chicago, Illinois

CANADIAN STANDARDS ASSOCIATION (LIAISON)

E. F. V. Robinson, National Research Council, Ottawa, Ontario, Canada

ELECTROCHEMICAL SOCIETY

Abner Brenner, National Bureau of Standards, Washington, D.C.

ILLUMINATING ENGINEERING SOCIETY

L. E. Barbrow, National Bureau of Standards, Washington, D.C.
J. E. Kaufman, Alternate, Illuminating Engineering Society, New York, N.Y.

INSTRUMENT SOCIETY OF AMERICA

George Platt, Bechtel Corporation, Los Angeles, California

INSTITUTE OF ELECTRICAL & ELECTRONICS ENGINEERS, THE

R. V. Rice, Bell Telephone Laboratories, Whippany, New Jersey
R. F. Shea, Alternate, Schenectady, New York

MANUFACTURERS STANDARDIZATION SOCIETY OF THE VALVE & FITTINGS INDUSTRY

R. V. Warrick, Manufacturers Standardization Society, Arlington, Virginia

MECHANICAL CONTRACTORS ASSOCIATION OF AMERICA, THE

J. R. Mance, Mance Corporation, New York, N.Y.

NATIONAL ASSOCIATION OF PLUMBING, HEATING, COOLING CONTRACTORS

R. E. White, South Bend, Indiana

NATIONAL DISTRICT HEATING ASSOCIATION

J. A. Sheppard, Jr., Consolidated Edison Company of New York, Inc., New York, N.Y.

NATIONAL ELECTRICAL CONTRACTORS ASSOCIATION

W. H. Paules, National Electrical Contractors Association, Inv., Washington, D.C.
Kenneth Priestley, The Eastern Electric Construction Co., Bridgeport, Connecticut

NATIONAL ELECTRICAL MANUFACTURERS ASSOCIATION

W. F. Huette, Allen-Bradley Company, Milwaukee, Wisconsin
F. V. Kupchak, Westinghouse Electric Corporation, Pittsburgh, Pennsylvania
E. Neary, Alternate, General Electric Company, Schenectady, New York
W. A. Samsonoff, Alternate, National Electrical Manufacturers Association, New York, N.Y.
Roland Russo, Alternate, Clark Controller Company, Cleveland, Ohio

NATIONAL FLUID POWER ASSOCIATION

J. L. Fisher, Jr., Bellows-Valvair, Akron, Ohio

SOCIETY OF AUTOMOTIVE ENGINEERS

H. L. Dubocq, Grumman Aircraft Engineering Corporation, Long Island, New York

TECHNICAL DRAWING ASSOCIATES

V. F. Dugar, Reliance Electric & Engineering Co., Cleveland, Ohio
R. N. Austin, Alternate, International Business Machines Corp., Endicott, New York

TELEPHONE GROUP

G. A. Eisner, Western Electric Company, Chicago, Illinois
R. V. Rice, Bell Telephone Laboratories, Whippany, New Jersey
R. E. Thieme, Alternate, Bell Telephone Laboratories, New York, N.Y.

U.S. DEPARTMENT OF COMMERCE PATENT OFFICE

D. M. Mills, The Commissioner of Patents, National Bureau of Standards, Washington, D.C.
C. H. Page, National Bureau of Standards, Washington, D.C.

U.S. DEPARTMENT OF INTERIOR

R. T. Montgomery, Department of Interior, Washington, D.C.

U.S. DEPARTMENT OF THE ARMY, ORDNANCE

C. A. Nazian, Frankford Arsenal, Philadelphia, Pennsylvania

U.S. DEPARTMENT OF THE NAVY BUREAU OF SHIPS

L. A. Meadows, Navel Ship Engineering Center, Hyattsville, Maryland

WESTERN UNION TELEGRAPH COMPANY

H. E. Wenzel, The Western Union Telegraph Co., New York, N.Y.

INDIVIDUAL MEMBER

C. A. Fricke, Philco-Ford Corporation, Willow Grove, Pennsylvania

**WRITING GROUP S1-2-W-39 -- SYMBOLS FOR MECHANICAL AND ACOUSTICAL ELEMENTS
(RESPONSIBLE FOR THE PREPARATION OF Y32.18)**

M. D. Burkhard, Chairman, Industrial Research Products, Inc., 321 North Bond Street, Elk Grove Village, Illinois 60007

B. B. Bauer, CBS Laboratories, High Ridge Road, Stamford, Connecticut 06900

**H. M. Trent*, U.S. Naval Research Laboratory, Washington, D.C.

Vincent Salmon, Department of Physics, Stanford Research Institute, Menlo Park, California 94025

W. C. Sperry, 1106 Brentfield Drive, McLean, Virginia 22101

E. L. Hixon, Department of Electrical Engineering, University of Texas, Austin, Texas 78712

*Deceased

AMERICAN NATIONAL STANDARDS COMMITTEE ON ACOUSTICS

OFFICERS

W. W. Lang, Chairman
Mrs. Avril Brenig, Secretary

PERSONNEL OF COMMITTEE S1

ACOUSTICAL AND INSULATING MATERIALS ASSOCIATION

H. J. Sabine, 102 Miller Avenue, Granville, Ohio 43023

ACOUSTICAL SOCIETY OF AMERICA

W. W. Lang, IBM Acoustics Laboratory, Poughkeepsie, New York 12602

Walter Koidan, Alternate, Section 213.01 (Sound), National Bureau of Standards, Washington, D. C. 20234

AIR-CONDITIONING AND REFRIGERATION INSTITUTE

R. W. Kelto, Airtemp Division, Chrysler Corporation, POB 1037, Dayton, Ohio 45404

R. J. Evans, Sr., Alternate, Air-Conditioning and Refrigeration Institute, 1815 North Ft. Myer Drive, Arlington, Virginia 22209

AIR MOVING AND CONDITIONING ASSOCIATION, INCORPORATED

R. E. Parker, Chicago Blower Corporation, 1675 Glen Ellyn Road, Glendale Heights, Illinois

AMERICAN SOCIETY OF HEATING, REFRIGERATING AND AIR CONDITIONING ENGINEERS

P. K. Baade, Carrier Corporation, Carrier Parkway, Syracuse, New York 13202

AMERICAN SOCIETY OF MECHANICAL ENGINEERS, THE

C. J. Hemond, Jr., Department of Mechanical Engineering, University of Hartford, POB 1948, Hartford, Connecticut 06101

AMERICAN SOCIETY FOR TESTING AND MATERIALS

Ralph Huntley, Cedar Knolls Acoustical Laboratories, 9 Saddle Road, Cedar Knolls, New Jersey 07927

†CANADIAN STANDARDS ASSOCIATION (Liaison)

T. D. Northwood, Division of Building Research, National Research Council, Ottawa 2, Ontario, Canada

ELECTRIC LIGHT POWER

C. S. Murray, Consolidated Edison Company of New York, Inc., 4 Irving Place, New York, New York 10003

ELECTRONICS INDUSTRIES ASSOCIATION

P. B. Williams, Jensen Manufacturing Company, 6601 S. Laramie Avenue, Chicago, Illinois 60638

INSTITUTE OF ELECTRICAL & ELECTRONICS ENGINEERS

C. G. Veinott, 4361 Clarkwood Parkway, Apt. 534, Cleveland, Ohio 44128

NATIONAL BUREAU OF STANDARDS

Martin Greenspan, National Bureau of Standards, Washington, D. C. 20025

NATIONAL ELECTRICAL MANUFACTURERS ASSOCIATION

R. S. Muso, Westinghouse Electric Corporation, Beulah Road, Pittsburgh, Pennsylvania 15235

†Without vote

SOCIETY OF AUTOMOTIVE ENGINEERS

J. A. Groening, General Motors Proving Ground, Noise and Vibration Laboratory, Milford, Michigan 48042

SOCIETY OF MOTION PICTURE AND TELEVISION ENGINEERS

Petro Vlahos, Association of Motion Picture and TV Producers Incorporated, 8480 Beverly Boulevard, Hollywood, California 90048

TELEPHONE GROUP

R. N. Thurston, Bell Telephone Laboratories, Murray Hill, New Jersey 07971

ULTRASONIC MANUFACTURERS ASSOCIATION

Edward Cook, Crest Ultrasonics Corporation, Mercer County Airport, Trenton, New Jersey

UNITED STATES DEPARTMENT OF THE ARMY, E. C. & L. (Liaison)

(To be appointed)

UNITED STATES DEPARTMENT OF THE AIR FORCE

Henning E. von Gierke, 6570 ARML (MRBA), U. S. Department of the Air Force, Wright Patterson AFB, Ohio 45433

UNITED STATES DEPARTMENT OF HOUSING AND URBAN DEVELOPMENT

G. E. Winzer, Office of the Assistant Secretary for Research and Technology, Department of Housing and Urban Development, Washington, D. C. 20410

UNITED STATES NAVY DEPARTMENT

Naval Ship Systems Command, Technical Society Liaison, NAVSHIPS Code 053, Washington, D. C. 20360

UNITED STATES DEPARTMENT OF THE NAVY

F. E. Hein, Code 041210, Naval Facilities Engineering Command, Washington, D. C. 20390

INDIVIDUAL MEMBERS

Laurence Batchelder, 983 Memorial Drive, Cambridge, Massachusetts 02138

R. W. Benson, Robert W. Benson & Associates, 633 Thompson Lane, Nashville, Tennessee 37204

L. L. Beranek, Bolt, Beranek and Newman, Incorporated, 50 Moulton Street, Cambridge, Massachusetts 02138

R. J. Bobber, NRL Underwater Sound Reference Division, POB 8337, Orlando, Florida 32806

R. K. Cook, Box A 311, Building 226, National Bureau of Standards, Washington, D. C. 20234

Hallowell Davis, Central Institute for the Deaf, 818 S. Euclid, St. Louis, Missouri 63110

R. W. Hasse, Jr., USN Underwater Sound Laboratories, Fort Trumbull, New London, Connecticut 06320

I. J. Hirsh, Washington University, Box 1094, St. Louis, Missouri 63130

C. W. Harton, 3213 Cherry Lane, Austin, Texas 78703

F. V. Hunt, 2621 Calle del Oro, La Jolla, California 92037

Douglas Muster, University of Houston, Houston, Texas 77004

A. P. G. Peterson, General Radio Company, 22 Baker Avenue, West Concord, Massachusetts 01781

Wayne Rudmose, Tracor, Incorporated, 6500 Tracor Lane, Austin, Texas 78721

R. W. Young, Naval Undersea R & D Center, San Diego, California 92132

**AMERICAN NATIONAL STANDARDS COMMITTEE ON MECHANICAL
VIBRATION AND SHOCK**

OFFICERS

D. C. Kennard, Jr., *Chairman*
Mrs. Avril Brenig, *Secretary*

PERSONNEL OF COMMITTEE S2

ACOUSTICAL SOCIETY OF AMERICA

Galt Booth, 44 Briston St., Short Beach, Connecticut
Harry Himelblau, 14206 Mulholland Drive, Los Angeles, California 90026

AMERICAN SOCIETY FOR TESTING AND MATERIALS

J. W. Goff, Michigan State University, East Lansing, Michigan 48823

AMERICAN SOCIETY OF MECHANICAL ENGINEERS, THE

Douglas Muster, University of Houston, Houston, Texas 77004
D. C. Kennard, Jr., Northwestern Michigan College, Traverse City, Michigan 49684

CANADIAN STANDARDS ASSOCIATION (Liaison)

T. D. Northwood, Division of Building Research, National Research Council, Ottawa 2, Ontario, Canada

ELECTRONIC INDUSTRIES ASSOCIATION

C. R. Muller, 3 Krollwood Drive, North Caldwell, New Jersey

INSTITUTE OF ELECTRICAL AND ELECTRONICS ENGINEERS

C. A. Arents, West Virginia University, Morgantown, West Virginia 26506

INSTITUTE OF ENVIRONMENTAL SCIENCES

R. G. Shoulberg, 6009 Musker Road, Fort Washington, Pennsylvania 19034

INSTRUMENT SOCIETY OF AMERICA

J. E. Monning, 105 Arena Terrace, Concord, Massachusetts

NATIONAL BUREAU OF STANDARDS

J. D. Ramboz, National Bureau of Standards, MB5, Sound Building, Washington, D. C. 20234

NATIONAL ELECTRICAL MANUFACTURERS ASSOCIATION

Samuel Levy, General Electric Company, One River Road, Schenectady, New York

NAVAL SHIP REARCH AND DEVELOPMENT CENTER

Harry Rich, (Code 701) Department of Structural Mechanics, Washington, D. C. 20007

SOCIETY OF AUTOMOTIVE ENGINEERS

M. L. Stoner, Alternote, SAE, 2 Pennsylvania Plaza, New York, N. Y. 10001

SOCIETY OF EXPERIMENTAL STRESS ANALYSIS

E. G. Fischer, Westinghouse Research Laboratories, Pittsburgh, Pennsylvania

TELEPHONE GROUP

J. P. White, Bell Telephone Laboratories, Whippany, New Jersey 07981

UNITED STATES DEPARTMENT OF THE AIR FORCE (Liaison)

Carl Goleuke, (FDDS), Air Force Flight Dynamics, Wright-Patterson AFB, Ohio 45433

UNITED STATES ARMY ORDNANCE CORPS (Liaison)

Stefan Bogolea, U.S. Army Materiel Command, AMCMA-WW, Washington, D. C. 20315

UNITED STATES DEPARTMENT OF DEFENSE

W. W. Mutch, (Code 6020) Naval Research Laboratory, Washington, D. C. 20390

UNITED STATES NAVY DEPARTMENT

Naval Ship Systems Command, Technical Society Liaison, NAVSHIPS Code 053, Washington, D. C. 20360

UNITED STATES NAVY ORDNANCE SYSTEMS

(To be appointed)

INDIVIDUAL MEMBERS

Laurence Batchelder, 983 Memorial Drive, Cambridge, Massachusetts 02138

L. L. Beranek, Bolt, Beranek & Newman, Inc., 50 Moulton Street, Cambridge Massachusetts 02138

R. K. Cook, Box A311, Bldg. 226, National Bureau of Standards, Washington, D. C. 20234

I. J. Hirsh, Washington University, Box 1094, St. Louis, Missouri 63130

Walter Koidan, Alternate, Section 213.01 (Sound) National Bureau of Standards, Washington, D. C. 20234

F. V. Hunt, 2621 Calle del Oro, La Jolla, California 92037

W. W. Lang, IBM Bldg. 704, Acoustics Laboratory, Poughkeepsie, New York 12602

Wayne Rudmose, Tracor, Incorporated, 6500 Tracor Lane, Austin, Texas 78721

H. E. von Gierke, 6570 AMRL (MRBA), Wright-Patterson AFB, Ohio 45433

R. W. Young, Naval Undersea R & D Center, San Diego, California 92132

ASMENORMDOC.COM : Click to view the full PDF of ASME Y32.18-1972

CONTENTS

	Page
1. Scope	1
2. Terms Used in Connection with Schematic Diagrams	1
3. Characteristics of Schematic Diagrams and Symbols	1
3.1 General	1
3.2 Coding	1
3.3 Terminals	1
3.4 Across Variables	2
3.5 Through Variables	2
3.6 Directivity	2
3.7 Labels	2
3.8 Notations	2
4. General Symbols	2
4.1 Rectilinear Motion	2
4.2 Rotary Motion	3
4.3 Acoustical (Eulerian)	3
4.4 Typical Application; Schematic Diagram	4
4.5 Perfect Coupler	4
4.6 Multi-Terminal Element	4
4.7 Supplementary Symbols	5
5. Description of Symbols	5
5.1 General	5
5.2 Symbols for Pure Inertances	5
5.3 Symbols for Pure Compliance	5
5.4 Symbols for Pure Dissipations	5
5.5 Symbols for Pure Sources for Excitations (Generators)	5
5.6 Symbols for Perfect Couplers	5
5.7 Symbols for General Elements	5
5.8 Supplementary Symbols	5
Appendix – General Information on Construction of Schematic Diagrams	6

Intentionally left blank

ASMENORMDOC.COM : Click to view the full PDF of ASME Y32.18 1972

AMERICAN NATIONAL STANDARD

SYMBOLS FOR MECHANICAL AND ACOUSTICAL ELEMENTS AS USED IN SCHEMATIC DIAGRAMS

1. Scope

This document presents standard symbols and definitions that may be used in constructing schematic diagrams for mechanical and acoustical systems whose performances are describable by finite sets of scalar variables. The choice of symbols described herein is based upon the following assumptions:

- a. A system can be divided conceptually into a finite set of elements each of whose dynamical properties are known.
- b. To each such conceptual element there can be assigned a set of terminals.
- c. Symbols for the elements shall be interconnected to form a schematic diagram for the whole system so that field equations shall be satisfied at every junction point and around every closed loop.

The symbols which appear in this standard were evolved with the following principles in mind:

- a. It shall be possible to draw the symbols easily and quickly.
- b. The symbol shall be distinctive and where feasible shall suggest some well-known embodiment of the element in question.
- c. The symbols shall preferably have been used previously in the scientific literature.

NOTE 1. Questions concerning the specific form for a so-called equivalent circuit of an electromechanical or any other type of mixed system are not within the scope of this standard.

NOTE 2. An Appendix (not a part of this standard) provides background information on the use of the symbols in constructing schematic diagrams.

2. Terms Used in Connection with Schematic Diagrams

The meanings to be attached to terms or expressions as used in this standard are to be consistent with the definitions in American National

Standard Acoustical Terminology (ANSI S1.1-1960 or latest revision) and American National Standard Letter Symbols for Acoustics (ANSI Y10.11-1953 (R 1959), or latest revision).

In addition, the following listed terms will be useful in schematic diagramming and therefore the sections of this document where they appear are tabulated.

Notations	3.8
Coding	3.2
Directivity of a Variable	3.6
Terminals	3.3

3. Characteristics of Schematic Diagrams and Symbols

3.1 General. The schematic symbols appearing in this standard contain the following types of information:

- a. Coding
- b. Terminals
- c. Directivity
- d. Labels
- e. Notations

The first two types of information are always present; the latter three may or may not be necessary in any specific case. The criterion that is used to decide whether they shall or shall not be included in a schematic symbol is whether or not they are needed for clarity and completeness of information.

3.2 Coding. The coding is that portion of a symbol which by its configuration specifies the characteristics of the physical element which stands in one-to-one correspondence with the symbol. Thus the symbols corresponding to the rigid masses and acoustical cavities will all have different codings. (See Subsection 4.4).

3.3 Terminals. The terminal is that portion of the symbol representing connection to adjoining elements or to points of physical access to the whole system. A terminal is represented by an

open circle joined to the coding by a line. (See Subsection 4.4).

3.4 Across Variables. Across variables describe quantities which are observable or act on an element relative to a reference.

3.5 Through Variables. Through variables describe quantities which are observable or are transmitted continuously through an element.

3.6 Directivity. Directivity is a property associated with a path connecting two terminals of the same element. It specifies either the reference terminal of the associated across variable or the direction of propagation of the corresponding through variable. In the former case a - sign is placed by the reference terminal and a + sign by the other terminal; in the second case an arrowhead is added to the line terminating on the reference node with the arrowhead pointing toward the reference node. (See Subsection 4.4).

NOTE: These two methods of indicating directivity are not independent for one implies the other. Thus it is not necessary or desirable to use both designations in the symbol for any element.

3.7 Labels. Labels are numbers or letter symbols placed beside or on the coding of an element. They are used as needed to provide information to a user of the diagram of a system. (See Subsection 4.4).

3.8 Notations. There will be certain items of information which will be needed in addition to the above symbol information in order to completely describe the system which corresponds to the diagram. These extra items of information may be added by a margin of the diagram and are called notations. Typical items that are contained in the notations are:

- a. Statements describing the coordinate systems assigned to the system;
- b. Definitions of labels;
- c. Constraints imposed by perfect couplers.

4. General Symbols

NOTE A: Letter notation labels identify modes of motion.

NOTE B: Sense of motion indicated by +, - or \rightarrow .

NOTE C: The exact meaning of the label must be given in notations for any non-linear dissipative element.

4.1 Rectilinear Motion

4.1.1 Inertance

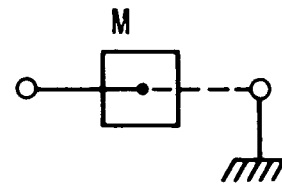

See 4.7.2.

4.1.2 Compliance



4.1.3 Dissipation

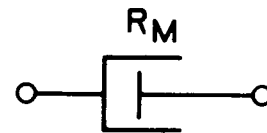

See Note C.

4.1.4 Generator (across variable)

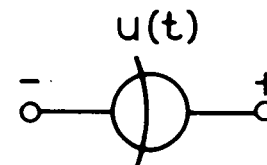

4.1.5 Generator (through variable)

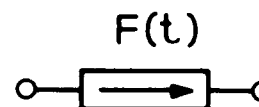

4.2 Rotary Motion

4.2.1 Inertance

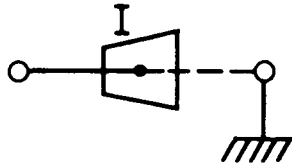

See 4.7.2.

4.2.2 Compliance

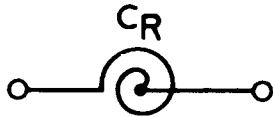

4.2.3 Dissipation

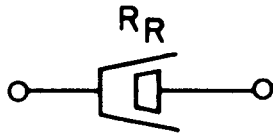

See Note C.

4.2.4 Generator (across variable)



4.2.5 Generator (through variable)

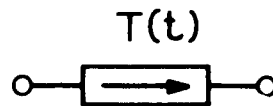

4.3 Acoustical (Eulerian)

4.3.1 Inertance

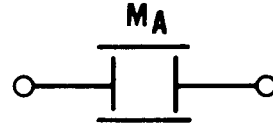

4.3.2 Compliance

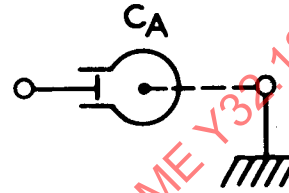

See 4.7.2.

4.3.3 Dissipation

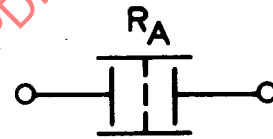

See Note C.

4.3.4 Generator (across variable)

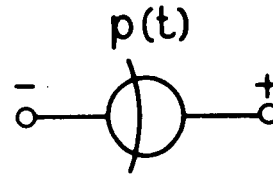

4.3.5 Generator (through variable)



4.4 Typical Application; Schematic Diagram

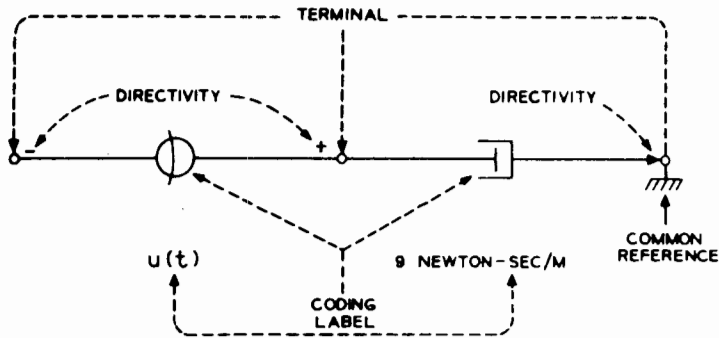

4.5.2 Inverse Coupler

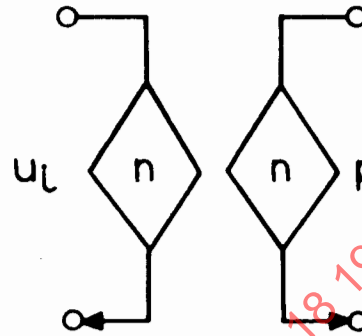

$$n: \begin{cases} f_i = sp_j \\ su_i + U_j = 0^* \end{cases}$$

4.5 Perfect Coupler

4.5.1 Direct Coupler

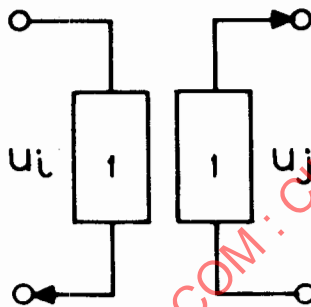

Examples of notations:

$$1: \begin{cases} u_i = 1u_j \\ 1f_i + f_j = 0^* \end{cases}$$

*Relation is redundant in that it can be inferred from the first relation and the fact that the element is a perfect coupler. It is helpful however to include it in the notations.

NOTE 1: Although only two sections are shown in the above symbols, by extension the element may include any finite number of sections.

NOTE 2: It is frequently the case that there are interconnections between the sections of a coupler.

4.6 Multi-terminal Element

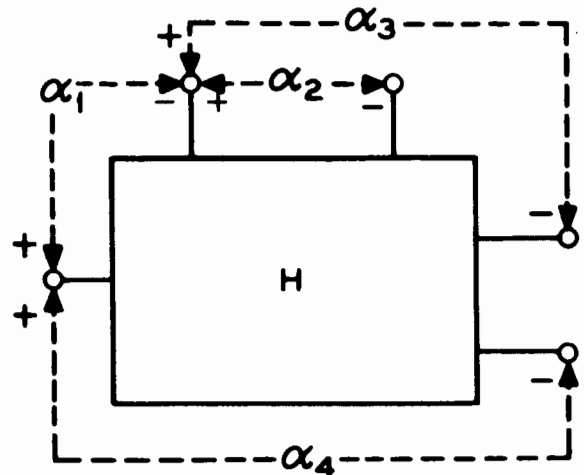

H defined in terms of the across variable α_i and the corresponding through variables.

4.7 Supplementary Symbols

4.7.1 Uncoded Line

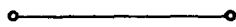

4.7.2 Reference Terminal



5. Description of Symbols

5.1 General. The standard symbols are listed in Section 4. General Symbols.

5.2 Symbols for Pure Inertances. Symbols for a pure inertance are suggestive of rigid pieces of matter or a portion of fluid within a stationary pipe. The coding contains a solid circle at its centroid, suggesting that the element can be specified precisely by considering only the motion of its center of mass and as if all forces were concentrated at this point.

5.3 Symbols for Pure Compliance. The Symbols for pure compliance are suggestive of springs in the case of rectilinear and rotary motions and of a cavity in acoustical systems.

5.4 Symbols for Pure Dissipations. The Symbols for pure dissipations are suggestive of a piston moving in a viscous oil, a disk spinning in a viscous oil, or a fluid being forced through a porous screen.

5.5 Symbols for Pure Sources of Excitations (Generators). The symbols given in Section 4 are simple and obvious modifications of the symbols used for electrical sources so as to allow ready distinction between the two types of energy sources. It should be noted that only two types of generators have had widespread use in mechanical and acoustical systems. In one type the value of an across variable is a specified function of the time; in the other a through variable is a specified function of the time. In either case the device has an inherent directivity so that their symbols must include this information.

5.6 Symbols for Perfect Couplers

5.6.1 General. A perfect coupler is a conceptual element which does not generate, store or dissipate energy, yet can transfer energy from

one part of a system to another. There are two types of couplers, the distinction being based on the nature of the constraints they impose. Symbols for perfect couplers are shown in Section 4.5.1 and 4.5.2.

5.6.2 Direct Couplers. A direct coupler transforms through and across variables in one system to through and across variables, respectively, in another system. It is necessary to assign directivities to all sections of a perfect coupler.

5.6.3 Inverse Couplers. An inverse coupler transforms across and through variables in one system to through and across variables in the other system, or vice versa. The sense of the direction of all sections of the coupler must be indicated.

5.7 Symbols for General Elements. Many mechanical and acoustical systems may be represented by lumped or pure elements given in Section 5.2 through 5.6 and often this is the most informative thing to do. Yet cases do arise in which it is advantageous to consider an interconnected set of pure elements as a single entity with perhaps multiple terminals. For example, generators are not easily included in an analysis if single 2-terminal elements are created conceptually by combining each pure generator with purely passive element. Such a conceptual combination is still called an element. The element must be labeled and its constitutive relations specified in the notations. Furthermore, if the element has more than two terminals the assignment of an independent set of across variables, say α_i must be specified between appropriate pairs of terminals. The symbol for a general multi-terminal element is shown in Section 4.6.

5.8 Supplementary Symbols. The following supplementary symbols may be used.

5.8.1 Uncoded Line. An uncoded line is used to interconnect any two (or more) terminals for which the appropriate across variable is always zero in the system being analyzed.

5.8.2 Reference Terminal. The reference terminal is used to identify a stable point of reference, normally external to the system being represented by the schematic diagram. The reference terminal need not represent an identifiable or fixed physical state. A minimum of one reference terminal should appear in any schematic diagram.

APPENDIX

General Information on the Construction of Schematic Diagram

A1 Purpose and Scope of Appendix

This appendix, although not a part of the standard, is provided for the use of readers so that they may have at hand a brief description of those concepts which provide the theoretical basis on which the construction of such diagrams rests and a summary of those techniques that have been found to have general applicability in this subject area.

A2 Basic Concepts

A2.1 The primary function of a schematic diagram is to provide a useful conceptual tool for analysis of physical systems. It is not surprising, therefore, that the concepts associated with the construction of schematic diagrams are derived from those constructs created in the mind of an analyst and those operations which he pursues in creating accurate descriptions of the performance of the systems. An analyst is concerned not only with an accurate description of the performance of a system but with the finding of accurate numerical predictions of its action. The descriptive phase of his work is partly conceptual and partly mathematical, while the predictive phase is purely mathematical and in fact concerns the formal solution of a set of equations usually integro-differential in form. It is important to realize that schematic diagrams are designed to be aids only in the descriptive phase of an analysis — not in the solution of mathematical relations. If an analyst seems to use a schematic diagram in predicting the performance of a system, it is probably because he has developed an intuition for the way solutions will come out by virtue of his having previously solved other systems having similar schematic diagrams. Hence this discussion will be limited hereafter to the descriptive phase of an analysis.

A2.2 As an analyst begins his consideration of a system he is faced with four sorts of arbitrary choices. The first of these concerns a decomposition of the given system into a set of simpler parts called elements. The notions behind such a decomposition can be viewed as follows. The fact that an analysis is being under-

taken implies that the performance of the system is not known in advance. However, the analyst can mentally divide the system into a sequence of smaller parts and this division can be carried to a point where the performance of each part is well known. The endpoint of the division is arbitrary, obviously, for arriving at a set of parts whose respective performances are known is a function of the training, experience and above all the taste of the analyst. The great majority of workers, however, prefer to carry a decomposition to the point where the resulting parts represent pure elements. Typical pure elements are inertias without any compressibility or viscous effects, springs without inertia, levers without inertia or springiness, generators without passive reactions, etc. It is to be noted that this standard concerns mainly symbols for pure elements although some allowance has been made for other elements.

A2.3 A decomposition assumes that each of the resulting elements has a known performance and that this performance can be specified accurately. The statement implies that the performance of an individual element can be represented by a set of mathematical relations. Clearly such a set of relations involves a set of variables and some parameters characteristic of the element. Relations of this sort are called *Constitutive Equations* and are a basic ingredient in every analysis. One of the prime functions performed by a schematic diagram is to suggest for each element the nature of its constitutive equations; in fact it is just the representation of this sort of information which in general makes one symbol differ from another. The process of adding this information is called *Coding the Diagram*.

Before constitutive equations can be written down, the analyst must select the variables which are used in the equations. That this choice is generally arbitrary is readily seen by examining a few situations. Take a pure spring as one such example. Its constitutive equation can be written in the form $f = -Ks$ where f is the force transmitted by the spring, K is its stiffness, and s is the extension of one end of the spring relative to

the other. However, it could be written equally as well in terms of variables which were time derivatives of f and/or s to any order. Other examples are easily found. Hence an analyst must specify the variables he expects to use in writing constitutive equations. Consistency requires that if a choice is made for one element, the same choice must be made for all other elements; thus a choice of variables is characteristic of the system as a whole. This second arbitrary decision on the part of the analyst is not always indicated in a schematic diagram. There are instances in which a letter symbol or notation in a schematic diagram might seem to imply a unique selection of variables. Two examples are the letter symbol placed beside the graphic symbol for a generator and the notation associated with the graphic symbol for a perfect coupler. Such symbols and notations are intended to be only suggestive and not mandatory in use.

A2.4 The third arbitrary choice which an analyst must make concerns which of those energy mechanisms present in a given system he shall analyze in detail. Consider a loudspeaker, for example. A certain amount of heat is produced by the flow of air about the voice coil and cone. Now the analyst must decide whether or not to describe this thermal mechanism in detail. Most generally it is not so described and its presence is indicated by assigning a viscosity to the relative motion of the voice coil and cone. Since in this case thermal effects are not analyzed in detail, the mechanism which produces heat is said to be dissipative, i.e., it converts energy from a form which is being analyzed in detail into a form which is not being so analyzed. The converse of this situation, namely an element which converts energy from a form not described in detail into one which is analyzed in detail, is called an energy source or generator.

Any element which does not convert energy to a form not being analyzed is of course called conservative. The important point here is that an analyst must make decisions of this sort prior to the drawing of a schematic diagram or the prosecution of a formal analysis.

A2.5 The final type of arbitrary decision which an analyst must make has to do with the possible introduction to approximations into the analysis. Typical examples of the idea being described here are (1) treating a lever as being rigid and massless whereas neither of these

conditions holds absolutely, and (2) considering the air in a short section of an acoustical pipe system to be a pure inertia whereas it is certainly compressible. Approximations of this sort are made regularly in practice and if done judiciously and with insight, very little error is introduced into an analysis. Again the point is that such approximations must be decided in advance of the construction of a schematic diagram, for such decisions affect the number of pure elements that must be represented in the diagram.

A2.6 There are certain basic mechanical concepts which must be kept in mind if one is to construct schematic diagrams with facility. To illustrate these notions, consider an element of a mechanical system. It is well known that this element can be treated as if it were subjected to (1) a set of forces (or fractions) which act at the surface of element, (2) a set of surface moments (or couples), (3) a set of body forces, and (4) a set of body moments. Forces of types (1) and (2) are usually elastic in their origins but not necessarily so, as for example with surface forces arising as a result of the reactions of surface charges with an electrical field. Furthermore, some of the moments under item (2) have their origins in the surface forces of item (1), but a moment can exist as a mechanical entity not uniquely decomposable into a set of forces and lever arms. An example of the latter is the moment created by a concrete wall on a protruding cantilever beam. By contrast, body forces and moments are associated with volume elements of the device. Well known examples of body forces are gravitational attractions and inertial forces, the latter being the more frequently encountered for they always appear wherever an inertance is accelerated. As for the fourth item, a magnetized bar placed in a uniform magnetic field experiences a body moment and no body force, and is thus an example of the fourth type of external excitation.

A2.7 In each of the four cases given in the previous section the forces or moments can be associated with a particular surface or point. This statement is obvious in the case of surface forces and moments. Body forces and moments can be associated with an appropriate centroid; for example inertial forces are accurately associated with the center of mass of the element. The points or surfaces at which forces or moments can be considered to act are called the *Terminals* of the element. The identification of terminals on

each element is a necessary step in the construction of any schematic diagrams.

A2.7.1 It is necessary to comment in passing that a terminal may or may not coincide with a physical junction in the original mechanical system. A physical junction implies a connection made by a process such as bolting, riveting, welding, soldering, etc. Such junctions characteristically do specify some of the terminals of elements but not all of them. For example, the point terminal associated with an inertial force is never created by any of the shop processes mentioned above. It is best, therefore, to think of terminals as being mental constructs and if one or more of the terminals so identified turns out to coincide with a physically created junction then this should be treated as just a happy circumstance.

A2.8 Forces and moments acting on the elements of a system were identified in sections A2.6 and A2.7 with the terminals of that element. It is well known that each of these forces or moments is a *Directed Quantity* where by "directed" we do not mean the notion of a directed vector in 3-space but rather the more elementary notion that the forces or moments act either into or out of the element. Now it is a general law of mechanics that the sum of the forces (or moments) acting into an element is always exactly equal to the sum of those leaving the element where clearly both surface and body excitations must be included in order to achieve a balance. This balance is true of each and every mechanical element no matter what it may be; hence it is a universal law applicable to all mechanical systems. A universal relation such as this is called a *Field Equation*.

A2.9 The field equation described in A2.8 can be interpreted as implying that forces (or moments) are propagated continuously through an element; i.e. as much force (or moment) comes out of the element as goes into it. Thus if it is assumed that forces and moments are transmitted continuously through an element then prediction of the action of the element when subjected to those excitations will be exactly those which occur in fact. This notion is called the *Principle of the Continuity of Force*. Thus forces (or moments) act as if they were transmitted continuously through an element and it is for this reason that such variables have been called by Firestone [1] *Through Variables*. One can go so far as to assert that any physical system can be analyzed if and only if it is possible to find through variables

which satisfy the continuity principles. For example, a necessary ingredient in the analysis of electric networks is Kirchhoff's current law which is thus one of the field equations for the discipline. It can be concluded therefore that a continuity principle must hold for every possible analysis, and that this notion when applied in any particular situation defines a field equation. This notion of continuity of through variables is so basic that it has been conventional from the very beginning of schematic diagrams to imply this principle by representing all elements of a system by coded continuous lines. Such a technique gives rise to junction points in the diagram and this in turn has led to a statement clearly motivated by the diagrammatical representation of a system to the effect that at all junction points the sum of the through variables entering a junction point must be equal to the sum of those leaving.

A2.10.1 There is a second type of field equation which is pertinent to an analysis of a mechanical system and hence of importance in the construction of schematic diagrams. To introduce this subject let us return to the constitutive equations for a linear spring end let us write this in the form

$$\frac{df}{dt} = Kv$$

where v is the relative velocity between the ends of the spring. One variable is the transmitted force, f , which is a through variable. The relation, however, requires the use of another variable, v , which is not a through variable. The important physical characteristic of this variable is that it involves two terminals of the element for its specification. On a more experimental level, it may be noted that the quantity can be measured by attaching a relative velocity meter to the two terminals of the spring so that the meter spans the spring. Variables which have this two-point property can be measured conceptually by attaching an appropriate meter at two terminals of an element, which property led Firestone [1] to call them *Across Variables* since meters for their measurement span the element. Across variables are in fact the difference of two like scalar quantities as they exist at the two terminals associated with the variables. These variables are also directed quantities because one terminal must be selected as a reference position and the scalar quantity at the other terminal then compared to the value existing at the

reference. Such a comparison automatically establishes a direction. It is a well known fact that the constitutive equations for any element will contain equal numbers of through and across variables; the example of the spring is a simple case of this general principle in which there is exactly one variable of each type.

A2.10.2 Assume now that there exists an ordered sequence of terminals

$$l_1, l_2, \dots, l_n$$

along a continuous path and with each terminal there is associated a scalar quantity giving the ordered sequence

$$\sigma_1, \sigma_2, \dots, \sigma_n.$$

Now define a set of across variables such as

$$a_1 = \sigma_2 - \sigma_1, a_2 = \sigma_3 - \sigma_2, \text{ etc.}$$

Let it be assumed also that the pair at the beginning and end of the sequence also define an across variable, say

$$a_n = \sigma_1 - \sigma_n.$$

Thus there are n across variables defined and these form a closed loop. One can think of a specified (or positive) way of traversing the loops noting that the positive direction of some of the variables corresponds to the direction assigned to the loop, a_1 for example, while the others are oppositely directed. Note now that if we add together all those across variables which are directed the same in the loop and then subtract the sum of all those which are oppositely directed, the result is identically zero. This is a universal property of across variables which is usually stated in the form: the algebraic sum of all across variables around a closed loop is zero. Such a general statement is a field equation which must hold regardless of the nature of the constitutive relations associated with the elements. An inverse statement of the same principle is the following: no system can be analyzed unless there can be found a set of across variables appropriate to the system under analysis having the property that their algebraic sum around every closed loop is zero. Thus it is seen that an analysis of a system cannot be consummated unless it is possible to select appropriate through variables which algebraically add to zero at every junction point and appropriate across variables which algebraically add to zero around every closed loop.

A2.10.3 In the case of fluids flowing through stationary pipes, there seems to be enough confusion about the choice of appropriate through and across variables to warrant a special comment, especially since this case is of fundamental importance with acoustic elements. It is customary (although not necessary) to analyze these fluid systems through the use of Eulerian variables. This means that no attempt is made to follow the motion of a particle of the fluid as it proceeds along the pipe, which is the procedure generally followed in describing the motion of rigid bodies. Instead one focuses attention on the flow of fluid past a given cross-section of the pipe. The section is stationary, of course, since the pipe was stated to be stationary. Clearly the volume flow of fluid past the section is a natural choice for the through variable. What then is an appropriate choice for the across variable? Universally this has been taken to be a difference in pressure. Such confusion as exists arises from the fact that to some workers a pressure implies a stress of a force-like quantity and certainly these quantities are through variables. The difficulty can be resolved immediately if it is recognized that a pressure is in fact a scalar quantity. Let us recall Pascal's principle in this connection. This principle as usually stated says that at any point in a fluid at rest the pressure is the same in every direction. This usual statement is not very precise, for what it really says is that no direction can be attached to the pressure at any point in a fluid. Since a direction cannot be assigned, clearly it is a quantity which has only a magnitude and is therefore a scalar quantity. Once this point is understood then clearly a pressure difference, being a difference of two scalar quantities associated with two terminals, is an appropriate across variable.

A2.10.4 Consider now an acoustical cavity which has a constitutive equation of the form

$$U = C_A \frac{d}{dt} (p_c - p_s)$$

where U is the volume flow into the cavity, C_A is its acoustical compliance and the quantity $(p_c - p_s)$ is the sound pressure. From the discussion in the previous section, it is seen that the sound pressure is an appropriate across variable for describing the performance of the element. It is written here in a form so that the actual scalar quantities appearing at the terminals are readily apparent. Let us now identify the ter-

minals associated with the across variable, sound pressure. Since p_c is a mean pressure inside the cavity, then it is associated with some point in the cavity at which this pressure exists. The quantity p_s however is not in the cavity at all but is associated instead with the average pressure of the air outside the cavity. Thus the second terminal is not physically in or a part of the cavity. This example serves to illustrate the fact that the terminals associated with an element need not always be physically on or in what at first glance appears to be the element. The situation can be kept straight if the analyst focuses his attention on the meaning of variables rather than the actual appearance of the element. Another common example of the same situation is found in the treatment of inertias whose performance is governed by the constitutive equation

$$f = m \frac{dV}{dt}.$$

Here the across variable V is a velocity of the mass relative to some inertial reference. Hence one of the two terminals is physically at the center of mass of the element while the other terminal is quite external to it.

A2.11 For purposes of analysis a system is conceptually divided into elements in order that constitutive equations can be written down. The system as a whole performs its function however only because the elements do not in fact operate in isolation but rather are joined together in some fashion. This means that at least two terminals of every element are also terminals for one or more other elements. The fact that some terminals are common to two or more elements is summed up in the statement that the system is *Connected*. A specification of the connection in a given system is called its *Connectivity*.

A2.12 It was pointed out in A2.10.1 that the directivity associated with an across variable designates one of the pair of terminals, across which the variable acts, as a reference terminal and vice versa. Frequently there is one terminal in a system which is a common reference terminal to several elements. Such a terminal carries the obvious name of *Common Reference*. Typical examples are a common inertial reference for rigid body systems in which case all across variables associated with inertias in the system share a common reference terminal and constant pressure references for acoustic pipe systems in which case the reference is usually the mean pres-

sure of the air. A common reference terminal is associated with a basic piece of information about the system under analysis; hence it is desirable to include this fact in a schematic diagram.

A2.13 A coded line in a schematic diagram is a topological item; i.e., it can be stretched, warped, or moved about in the diagram. Clearly then it is not a vector in the 3-dimensional space sense. The directivity that is associated with it concerns only which of its terminals is a reference point. It must be concluded therefore that a line in a schematic diagram is associated with a pair of scalar variables, one through and one across.

A2.14 Consider now the problem of creating a schematic diagram for a system which moves about in the x - y plane, in which case it is conventional to think of forces and velocities as true space vectors. How then does one deal with this situation knowing that the parts of a schematic diagram can correspond only to scalar quantities? The answer is that one now thinks of a vector not in the elementary sense of a directed quantity in 3-space but rather in the more general sense that a vector is a collection of scalar quantities usually written as a linear array either as a single line or as a column. This is a matrix notion of course. If this notion is applied to the problem at hand, then a vector force acting on an inertia for example can be represented by the array of scalar quantities

$$[f_x, f_y]$$

where the subscript x means the force acting in the x direction and likewise for the subscript y . In a similar fashion, the vector velocity of the inertia can be represented by the array

$$[u_x, u_y]$$

The procedure then is to create a connected diagram which is associated only with forces and relative velocities acting in the x -direction and a second connected diagram which concerns only forces and motion in the y -direction. These two connected diagrams, which are called subnetworks, will contain elements which show that the two sorts of motions react on each other. The diagrammatic element which shows this action is called a perfect coupler. It is perfect in the sense that it does not create, supply, store, or dissipate energy. It can, however, transfer energy. Furthermore, it is a diagrammatic element which can define an interaction without producing